



Chipsmall Limited consists of a professional team with an average of over 10 year of expertise in the distribution of electronic components. Based in Hongkong, we have already established firm and mutual-benefit business relationships with customers from,Europe,America and south Asia,supplying obsolete and hard-to-find components to meet their specific needs.

With the principle of “Quality Parts,Customers Priority,Honest Operation,and Considerate Service”,our business mainly focus on the distribution of electronic components. Line cards we deal with include Microchip,ALPS,ROHM,Xilinx,Pulse,ON,Everlight and Freescale. Main products comprise IC,Modules,Potentiometer,IC Socket,Relay,Connector.Our parts cover such applications as commercial,industrial, and automotives areas.

We are looking forward to setting up business relationship with you and hope to provide you with the best service and solution. Let us make a better world for our industry!



## Contact us

Tel: +86-755-8981 8866 Fax: +86-755-8427 6832

Email & Skype: info@chipsmall.com Web: www.chipsmall.com

Address: A1208, Overseas Decoration Building, #122 Zhenhua RD., Futian, Shenzhen, China



### Features

- Low Loss
- Low Ripple
- Small Size

### Description

Surface mount, silver (Ag) coated ceramic filter for use in broadband applications.

Weight: 1.6 grams typical

Material: Filter is composed of a ceramic block plated with Ag

Filter complies with RoHS standards.

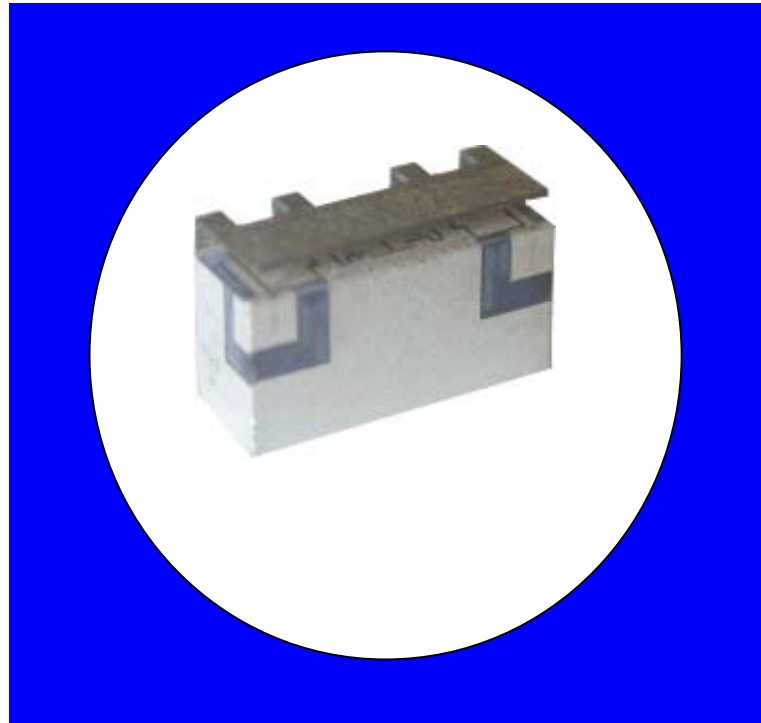

### Electrical Specifications

Parameter	Frequency MHz	Typical @ 25°C	Specification @ 25°C	Spec over -40°C to +85°C
Passband Iloss	698 - 746	-1.5	-1.8	-2.0
Passband Ripple	698 - 746	0.8	1.3	1.5
Passband Return Loss @ Port 1	698 - 746	-12.5	-11.0	-11.0
Passband Return Loss @ Port 2	698 - 746	-12.5	-11.0	-11.0
Attenuation	560 - 668	-18.9	-15.0	-15.0
	824 - 849	-30.7	-25.0	-25.0
	849 - 970	-39.2	-35.0	-35.0
Power into any port		4 Watt max		

Note: Supplier shall test each filter to the critical electrical specifications of the above table. Any subsequent audits may deviate from in value due to measurement repeatability among different test systems. Such deviations shall not exceed the following limits:

Specification Allowance	
Insertion Loss	0.1 dB
Return Loss	1.0 dB
Stopbands	1.0 dB

\*This product is covered by one or more of the following U.S. and foreign patents including: US 4,692,726;US 4,742,562; US 4,800,348;US 4,829,274;US 5,146,193;EP 0573597;DE 0573597;FR 0573597;JP 508149/92;KR 142171;US 5,162,760;US 5,218,329;US 5,250,916;US 5,327,109;US 5,488,335;CA 2114029;FR 9306297;GB 2273393;JP 3205337;KR 115113;CN 93106228.4;US 5,512,866;EP 0706719;DE 0706719;FR 0706719;GB 0706719;CN 95190359.4;US 5,602,518;US 5,721,520;US 5,745,018;EP 0910875;DE 0910875;DK 0910875;FR 0910875;GB 0910875;IE 0910875;JP 505182/98;KR 10-323013;US 5,994,978;US 6,462,629;CN 00810420.4;US 6,559,735;US 6,650,202;US 6,834,429. Other US and foreign patents pending.

\*CTS Corporation 2006 reserves all copyrights in the layout, design and configuration of the patterns on this product.\*

### Mechanical Drawing

Revision B - Origin Date: February 17, 2010 – Revision Date: July 11, 2011

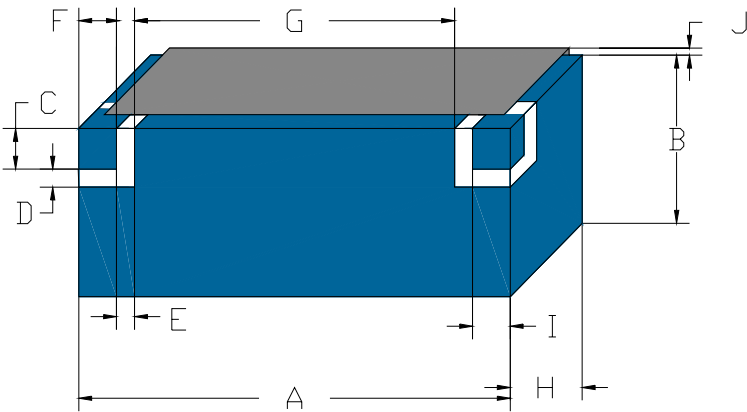

Dim	Nominal (mm)	Tolerance (mm) +/- or max
A	9.91	max
B	9.78	max
C	1.53	0.13
D	0.95	0.13
E	0.95	0.13
F	1.53	0.13
G	4.94	0.13
H	4.00	max
I	1.53	0.13
J	1.46	0.13

### Electrical response

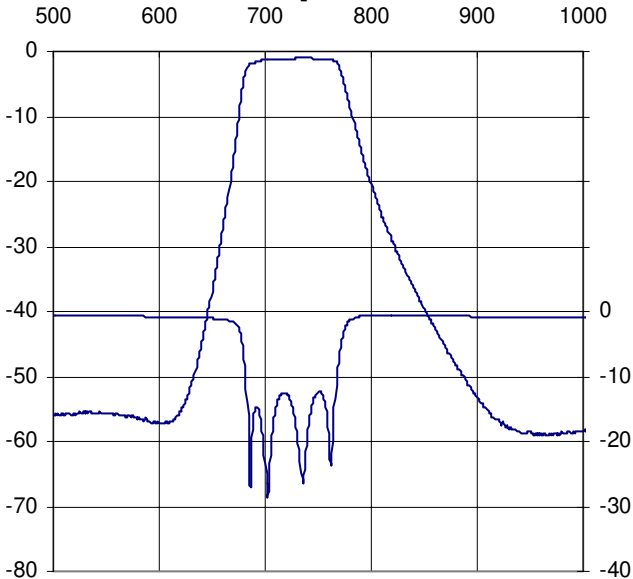

### PCB Layout

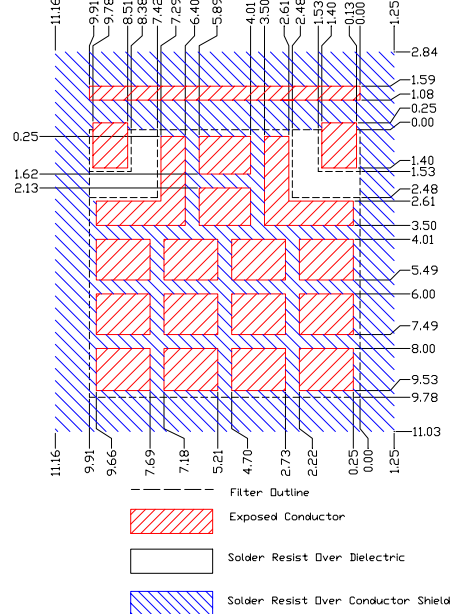

### Packaging and Marking

DIMENSION	UNITS	SPECIFICATION
REEL DIAMETER	mm	330
REEL WEIGHT	kg	1.6
REEL QUANTITY	ea.	1000

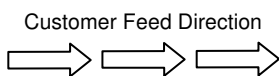

#### Product Marking

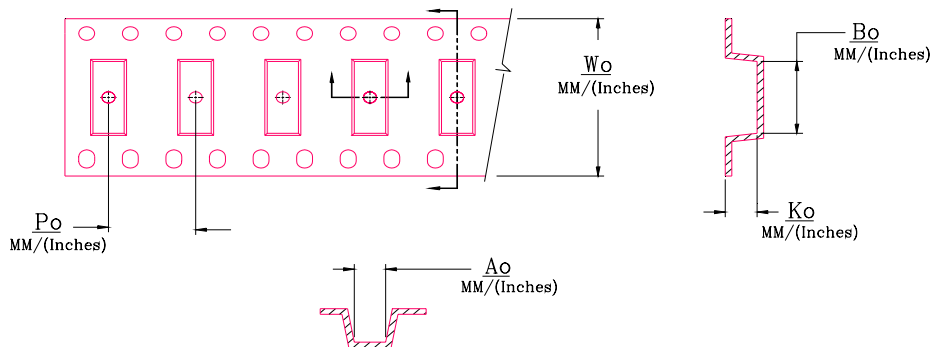
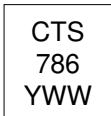

$W_o$	$A_o$	$B_o$	$K_o$	$P_o$
Inches/mm	Inches/mm	Inches/mm	Inches/mm	Inches/mm
0.945" / 24.0	0.449" / 11.4	0.402" / 10.2	0.169" / 4.3	0.630" / 16.0