



Chipsmall Limited consists of a professional team with an average of over 10 year of expertise in the distribution of electronic components. Based in Hongkong, we have already established firm and mutual-benefit business relationships with customers from,Europe,America and south Asia,supplying obsolete and hard-to-find components to meet their specific needs.

With the principle of "Quality Parts,Customers Priority,Honest Operation,and Considerate Service",our business mainly focus on the distribution of electronic components. Line cards we deal with include Microchip,ALPS,ROHM,Xilinx,Pulse,ON,Everlight and Freescale. Main products comprise IC,Modules,Potentiometer,IC Socket,Relay,Connector.Our parts cover such applications as commercial,industrial, and automotives areas.

We are looking forward to setting up business relationship with you and hope to provide you with the best service and solution. Let us make a better world for our industry!



## Contact us

Tel: +86-755-8981 8866 Fax: +86-755-8427 6832

Email & Skype: info@chipsmall.com Web: www.chipsmall.com

Address: A1208, Overseas Decoration Building, #122 Zhenhua RD., Futian, Shenzhen, China





## **Wiring and Assembly Instructions**

**for circular connectors per MIL-C-5015  
and VG 95234**

# Standard Circular Connectors

---

## Table of Contents

Components of connectors _____	3
Assembly tools _____	8
Assembly aids _____	12
Wiring instructions _____	16
Shielding braid _____	19
Useful hints _____	21

The connector family for which these assembly instructions have been provided is based on the MIL-C-5015 and related specifications. The connectors according to MIL-C-5015 and VG 95342 feature thread coupling, while the connectors according to VG 95234 feature bayonet coupling.

Mounting and overall dimensions for receptacles as well as for receptacles with strain relief are identical for all series mentioned. The connectors therefore are interchangeable. The wiring tools we recommend have proven to be the most suitable and safest ones for serial production. They meet the requirements according to VG 95236 which are stringent for maintenance in the army.

# Connector Components

## Receptacles

The receptacle shells are made of aluminium alloy, the surface is cadmium plated with olive drab color. The one-piece insulator is made of Polychloroprene.

Contacts are of copper alloy with hard silver finish. Either insulator for pin or socket contacts may be installed in any receptacle. For receptacles with strain relief additional parts as endbell, grommet and ferrule have to be added.

## Plugs

The connectors consist of a barrel and coupling nut, both made of aluminium alloy, which is cadmium plated with olive drab surface. The one piece insulator is made of Polychloroprene. The contacts made of copper alloy are hard silver plated.

For strain relief types other parts like endbell, grommet, ferrule and cable clamp have to be added.

## Components of Connectors

The drawings on pages 4-7 show the connector components and how they have to be assembled during the harnessing process. These tables are based on the VG 95234 connector series. For other series assembly is similar. Order numbers for components are shown in drawing No. K26026Yxxx which is available upon request.

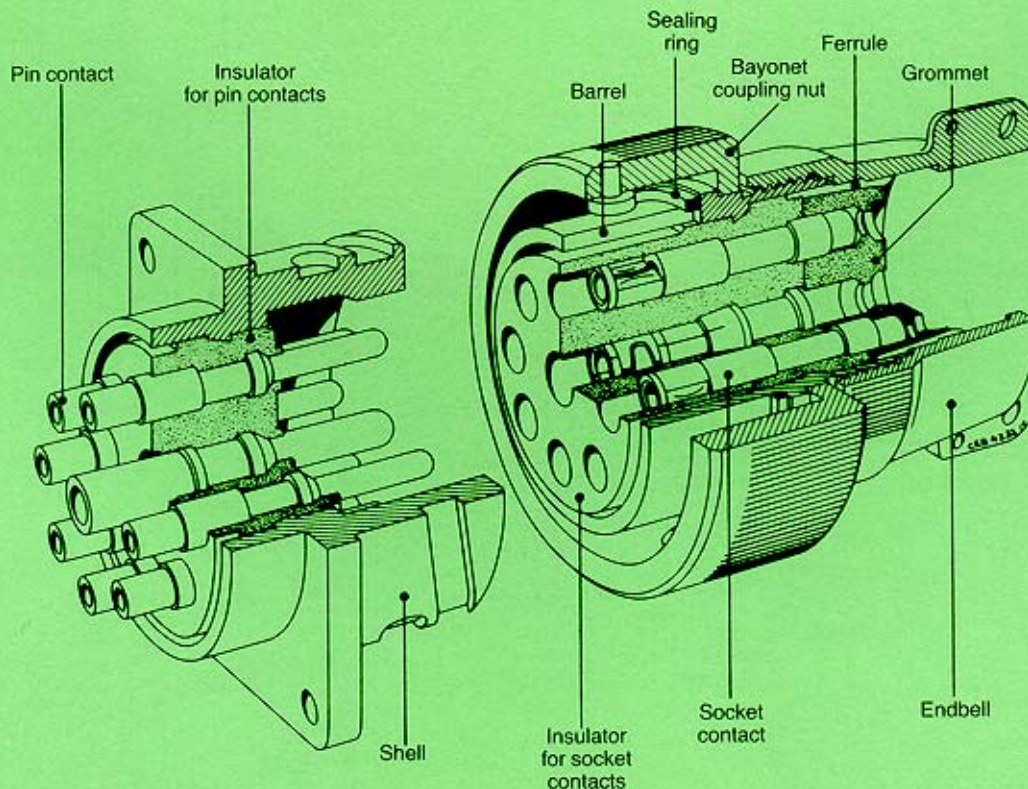

# Connector Components

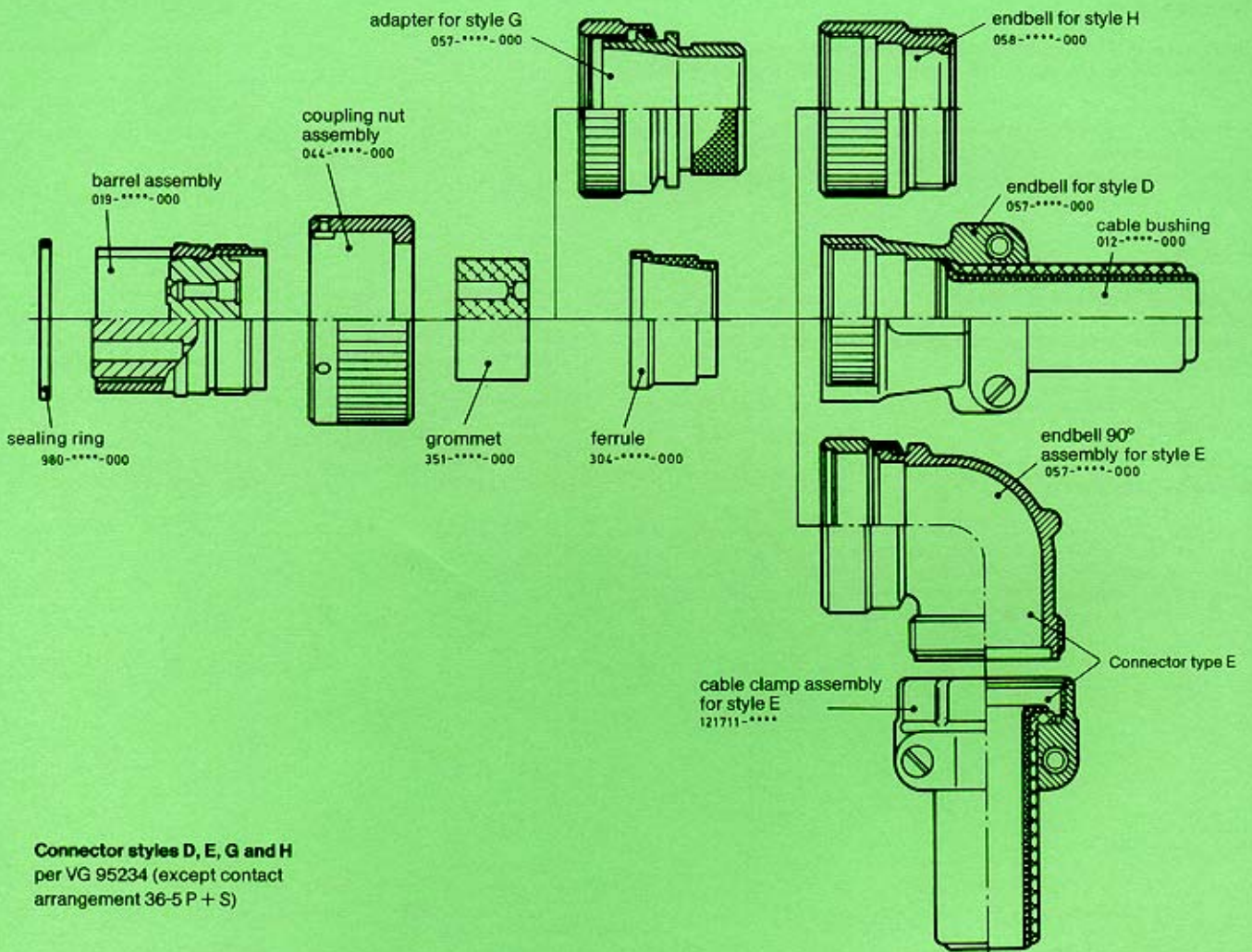

**Connector styles D, E, G and H**  
 per VG 95234 (except contact  
 arrangement 36-5 P + S)

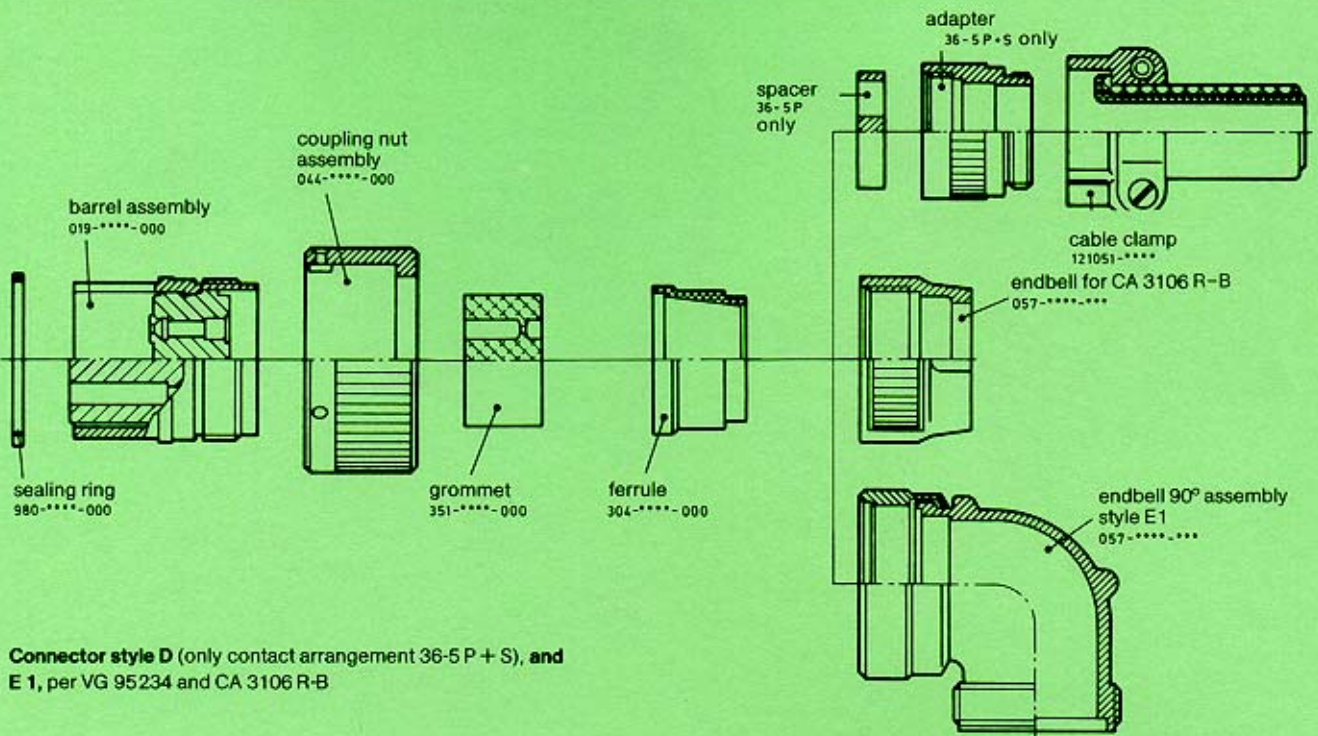

**Connector style D (only contact arrangement 36-5 P + S), and E 1,**  
 per VG 95234 and CA 3106 R-B

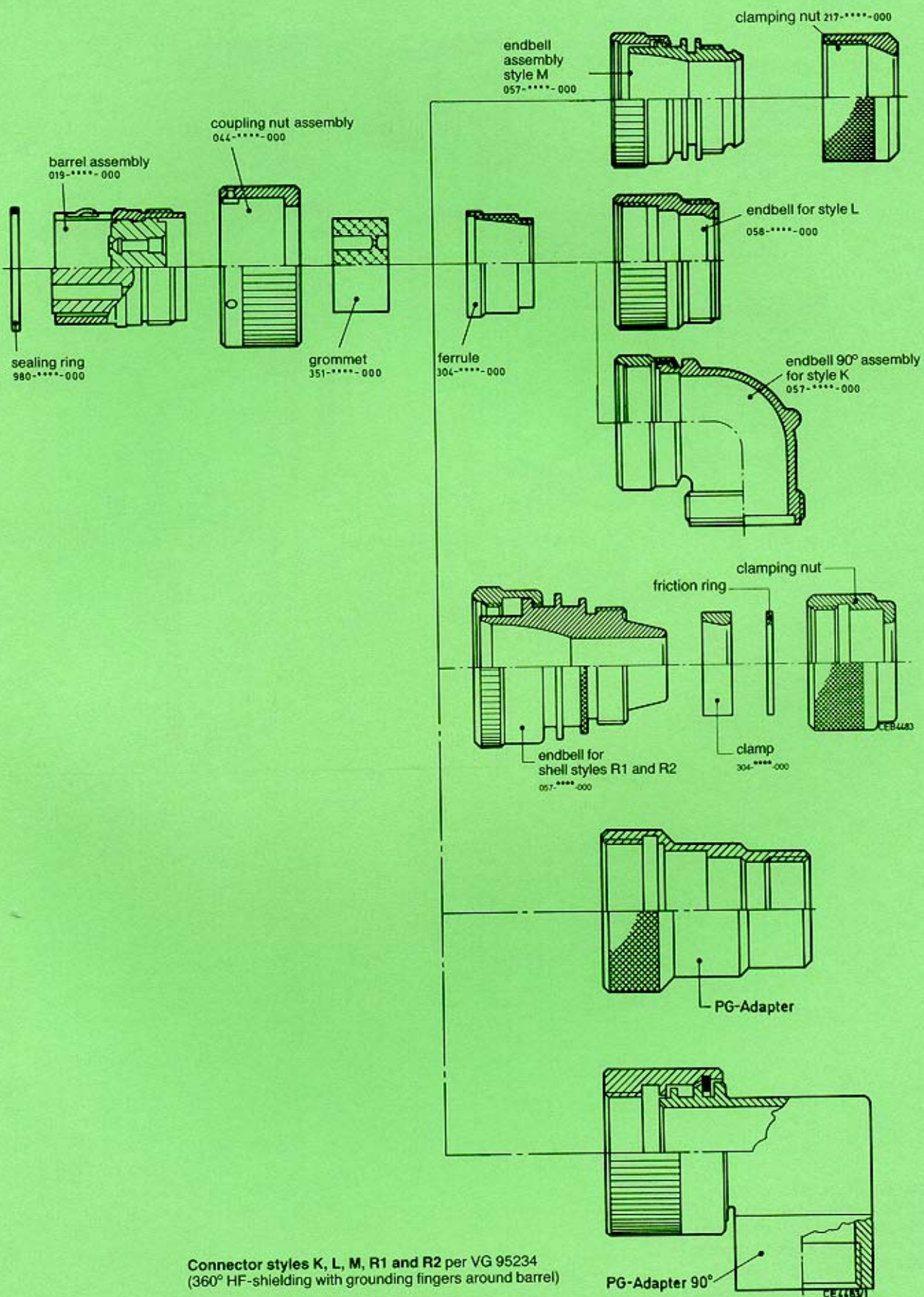

Connector styles K, L, M, R1 and R2 per VG 95234  
 (360° HF-shielding with grounding fingers around barrel)

# Connector Components

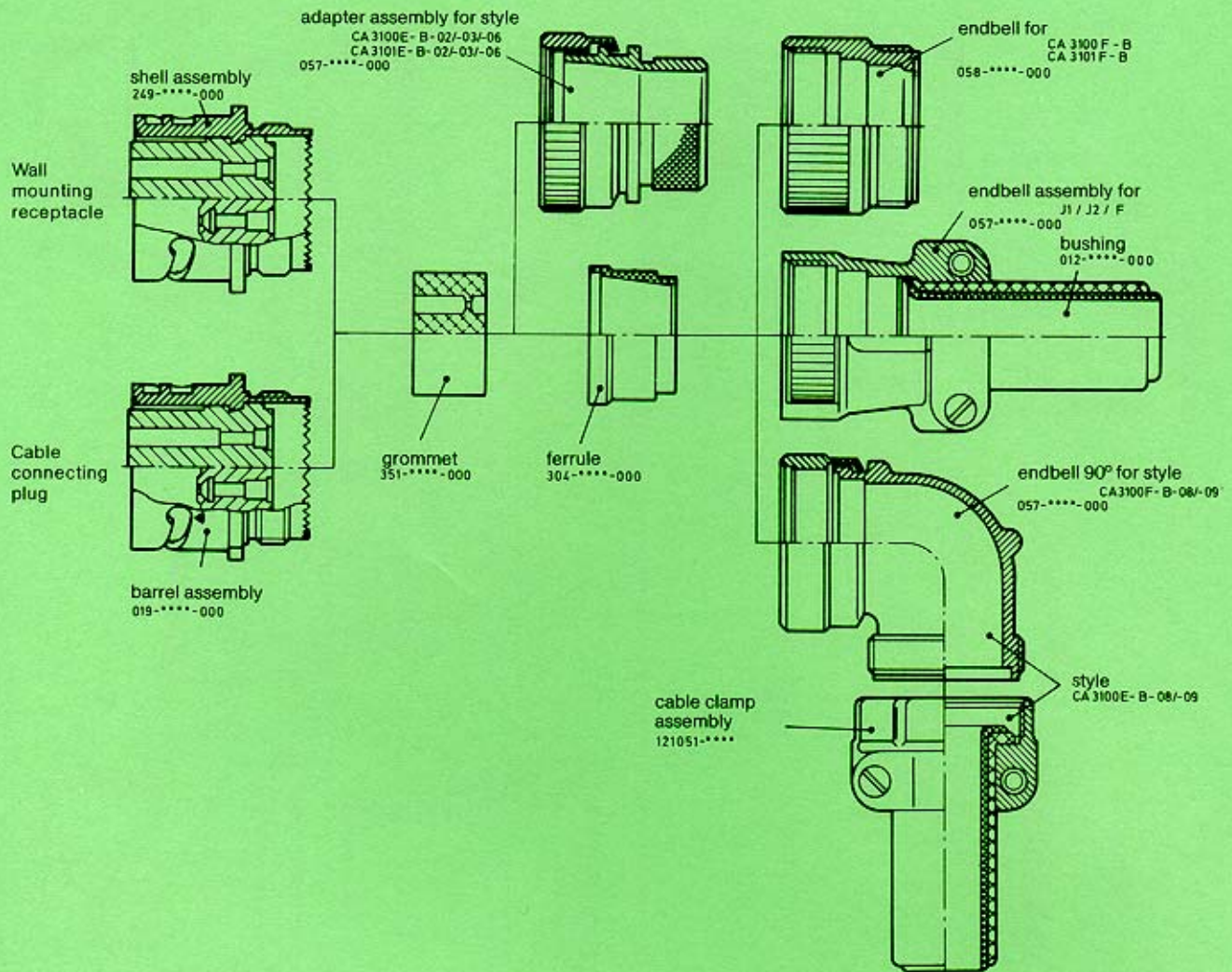

**Connector styles F, J1, J2** per VG 95234,  
 CA3100E-B-02/03/06, CA3101E-B-02/03/06,  
 CA3100F-B, CA3101F-B, CA3100E-B-08/09,  
 CA3101E-B-08/09, CA3100F-B-08/09 and  
 CA3101E-B-08/09

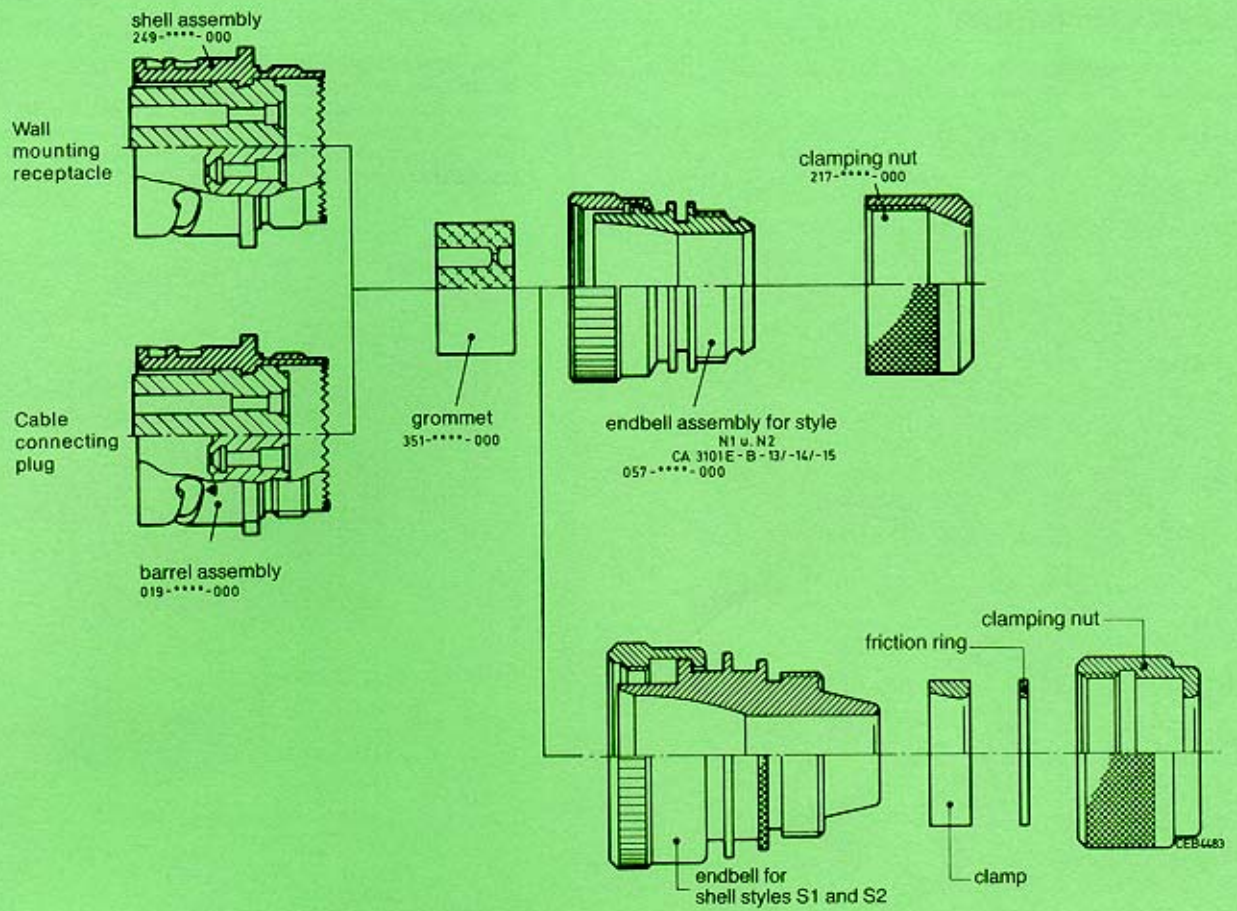

**Shell styles N1, N2, S1 and S2**  
 per VG95234 and CA3101E-B-13/14/15



# Assembly tools

## Hand crimp tools

To crimp contacts sizes 10, 15S/16S, 15/16 and 25/12 you need manually or pneumatically operated crimp tools.

Two versions are available:

### MS 3191-A

This simple tool providing a four-indent crimp requires a locator for each contact size. It is a ratched handtool with self-locking mechanism. It can



only be opened, respectively the contact can only be removed after the crimping operation has been fully performed. Main application is repair work in all military maintenance and service installations, prototype assembly as well as small series production.

#### Order Numbers for locators

Contact Size For contacts per MIL-C-5015, VG 95342, VG 95234, CA Series, CA-BAY. Series

Contact Size	pin contact	socket contact
10	600 219	600219
15S/16S	600 093	600 094
15/16	600 091	600 092
25/12	600 216	600 216

Spare locator (1 piece) 616097

### 612 600

This tool corresponds to MS3191-A, however, it features an 8-indent crimp.

Spare locator (1 piece) 616 098

Do not use tool MS3191-A when reduction sleeves are applied.

### M22520/1-01

This universal tool features just one crimp turret with different adjustments for crimping contacts of size 10, 15S, 15, 16S, 16, 25 and 12. The tool provides an 8-indent crimp. Compared with the tool MS3191-A it is a little bit more sophisticated to handle. Therefore only trained labor should use it. Main applications are prototype assemblies, repairs and low volume production.

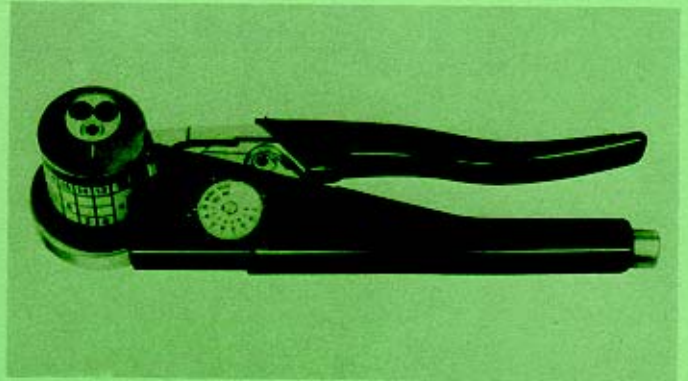

Order numbers for the crimp turret:

Contact size	Turret for pin contact	for socket contact
15S/16S } 15/16 } 25/12 }	TH 452 or 600324	TH 452 or 600325
10	600325	600325

Spare locator (1 piece) 701 1707  
Spare sticker for 600 324: 970-8606-005  
Spare sticker for 600 325: 970-8606-006

## Pneumatic crimp tools

For volume production two different pneumatically operated crimp tools are available. A work tray including a pedal for foot operation can also be provided.

### Standard version

Similar as the hand tool MS3191-A, each contact size and contact style requires a specific locator:

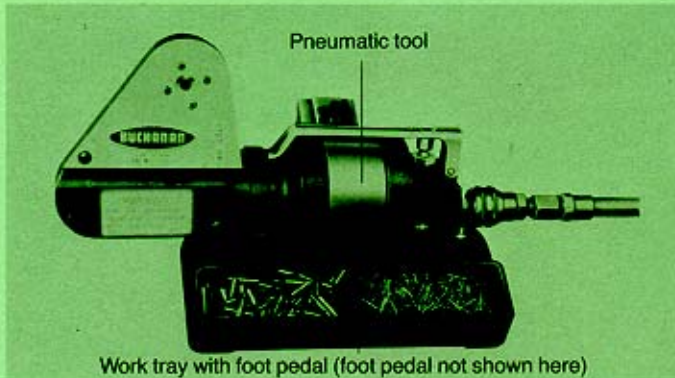

### Order Nos.

611 221 for pneumatic operated crimp tool with 4-indent crimp  
 612 871 for pneumatic operated crimp tool with octadent crimp  
 611 380 for bench provision with foot pedal:

Locators for contact size	for pin contacts	for socket contacts
15S/16S	600 082	600 083
15/16	604 292	600 081
25/12	600 099	600 099
10	600 098	600 098

Pneumatic tool 611 221 cannot be used when reduction sleeves are applied.

### Universal Tool

This tool is comparable with the hand crimp tool 22520/1-01. It features two crimp turrets which allow the operator to crimp all contact sizes from 10, 15S/16S, 15/16 to 25/12 with only changing the adjustment to the desired contact size.

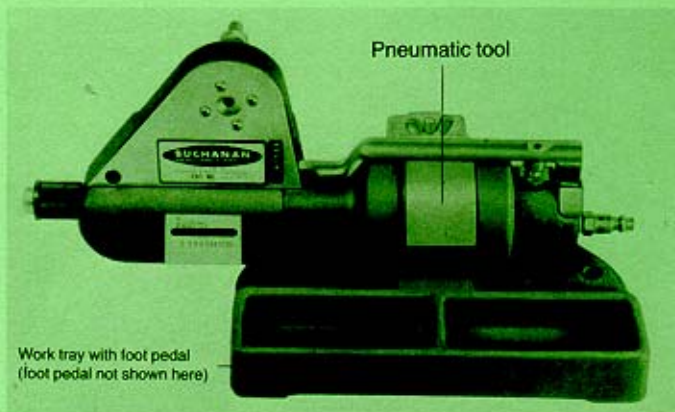

### Order Nos.

612 141 for pneumatically crimp tool  
 611 380 for bench provision including foot pedal  
 for crimp turret see M22520/1-01

Details on operation and maintenance of hand and pneumatically operated crimp tools are contained in the operation instructions supplied by the manufacturer.

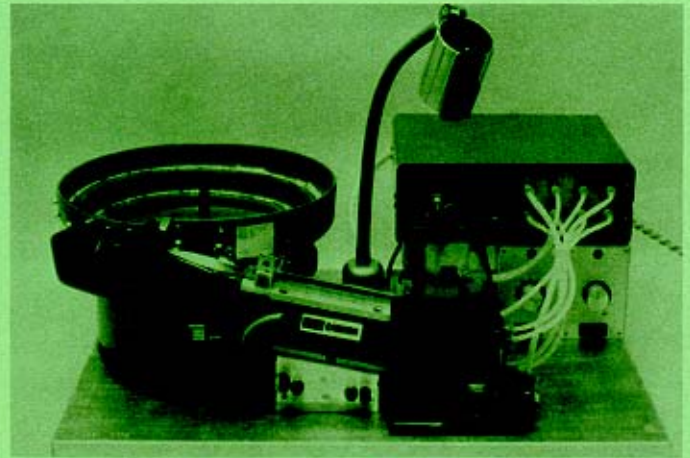

Note:  
 For large series a semi-automatic crimp station is available in addition to the two pneumatic tools described on this page. A shuttle automatically feeds the contacts into the crimp tool. Please contact factory.

# Assembly tools

## Hydraulic Crimp Tools

for contact sizes 60/100/8, 160/4 and 500/0

To crimp these contact sizes hydraulically operated tools are required. The crimp head is connected with the tool by a high pressure hose. Crimp dies for the different contact sizes are to be inserted into the crimp head. The hydraulic tool can be operated by means of hand or foot pump as well as an electric motor.

### Order Nos.

Hydraulic tool, hand operated, including safety valve:  
4601.00000.330

foot operated device for above hand pump:  
4601.51000.330

Electric pump:  
4608.00000.020, 4608.00000.00 C, 4608.00000.00 E

High pressure hose, 2 m:  
4604.00000.020

Crimp head:  
4632.00000.601

Durability = 20.000 operation cycles

Crimp dies for contact size	order no.	wrench width
60/100/8	317-8531-000 (upper crimp die)	5,2 ± 0,1
	317-8531-001 (lower crimp die)	
160/4	317-8532-000 (upper crimp die)	7,25 ± 0,1
	317-8532-001 (lower crimp die)	
500/0	317-8533-000 (upper crimp die)	11,4 ± 0,1
	317-8533-001 (lower crimp die)	

Bench mounting  
CT 121086-3079

Positioner  
CT 121086-3080



### Electric pump

4608.00000.020  
Basic model  
Hand lever operated

4608.00000.00 E  
Push-button operated  
With electro-magnetic valve

4608.00000.00 C  
Push-button operated  
With electro-magnetic valve  
and switching device

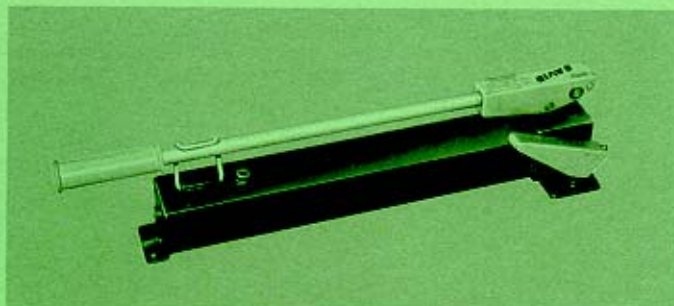

Pump, hand operated

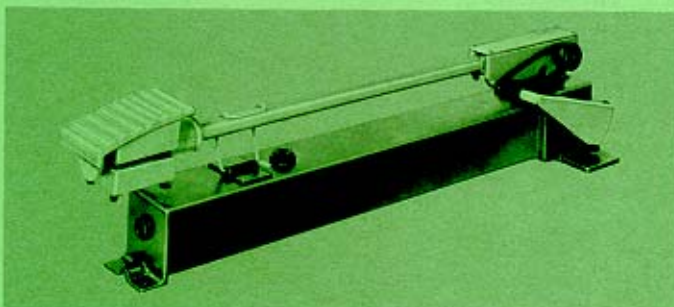

Pump, foot operated

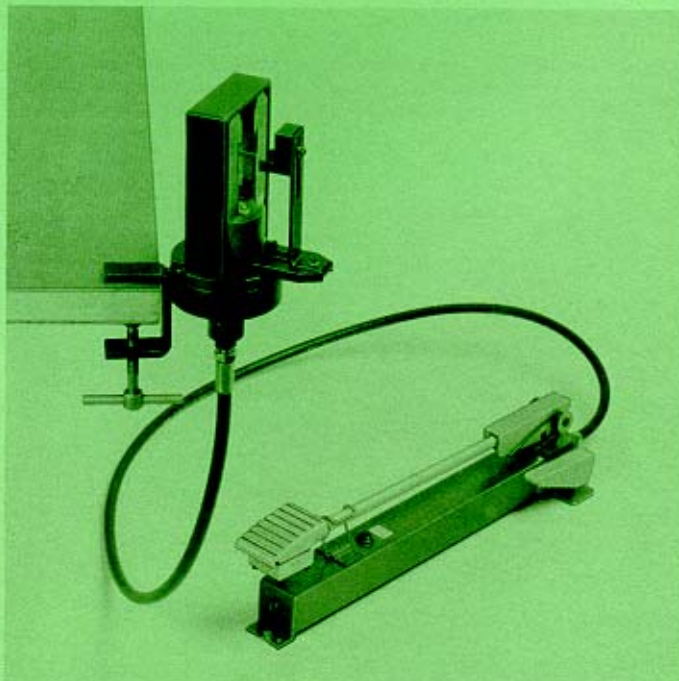

Pump, foot operated, with crimp head, crimp dies, safety device, bench mounting, positioner and high pressure hose

## Insertion Tools

To insert crimped contacts into the insulator insertion tools are required. Proper assembly is only ensured if the following insertion tools are used:

### Order nos. for insertion tools:

for contact size	Insertion tool	Insertion pliers
10	CIT-20*	CIT-F80-20
15S/16S/15/16	CIT-16*	CIT-F80-16
25/12	CIT-12*	CIT-F80-12
60/100/8	CIT-8*	
160/4	CIT-4*	
500/0	CIT-0*	

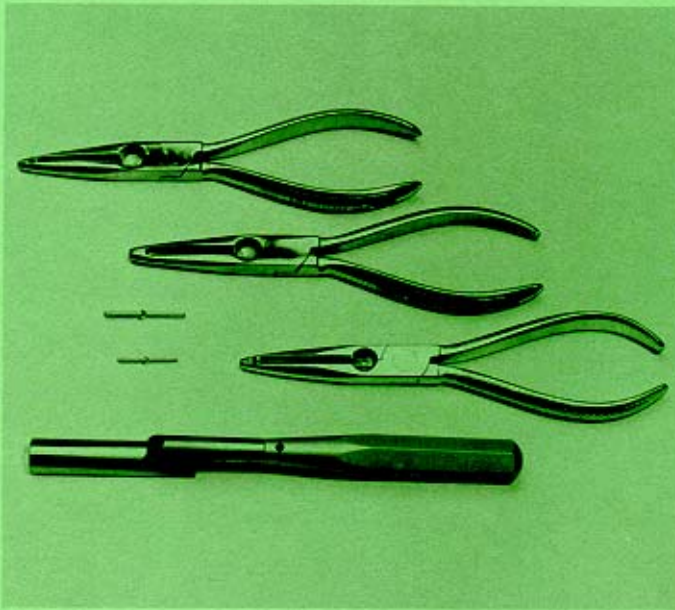

\* The tips for the insertion and extraction tools are available with a handle as a kit.

Insertion tool kit                    CIT-F80-Kit  
Extraction tool kit                CET-F80-Kit

Guide pins allow easy insertion of socket contacts sizes 15S/16S, 15/16 and 25/12 into the insulator. Without the use of these guide pins during contact insertion the insulator/contacts may be damaged.

### Order no. for guide pins:

Socket contacts size 15S/16S/15/16                    226-1017-000  
Socket contacts size 25/12                                226-1018-000

## Extraction Tools

In case a contact has to be exchanged the following extraction tools are to be used:

### Order nos. for extraction tools:

for contact size	Extraction tool
10	CET-F80-20*
15S/16S/15/16	CET-F80-16*
25/12	CET-F80-12*
60/100/8	CET-8*
160/4	CET-4*
500/0	CET-0*

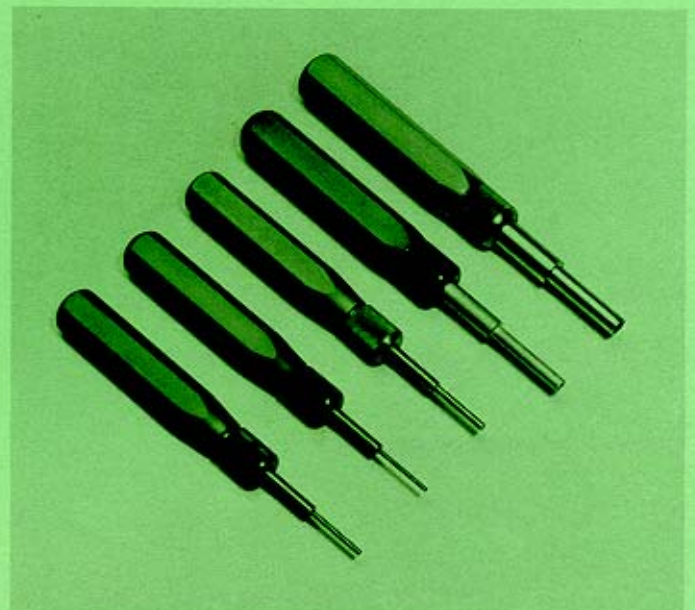

for pin contacts

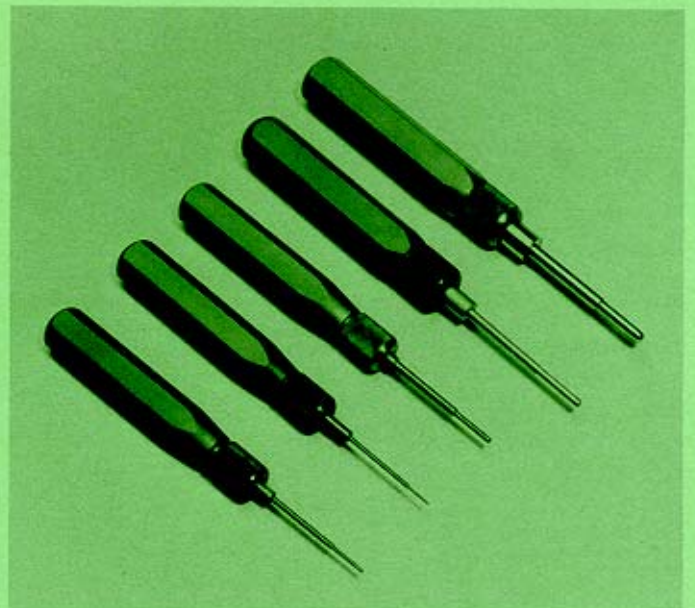

for socket contacts

# Assembly aids

## Assembly shells

for threaded coupling connectors

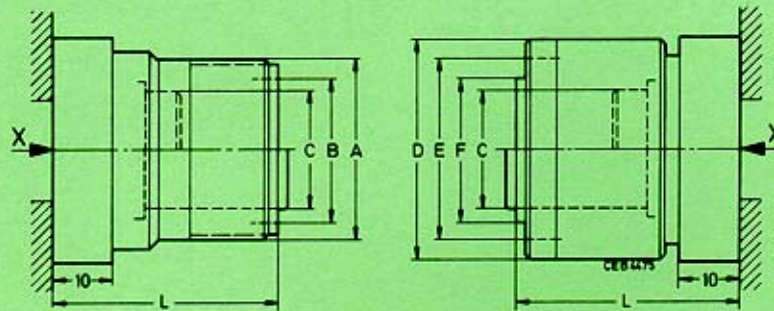

for bayonet coupling connectors

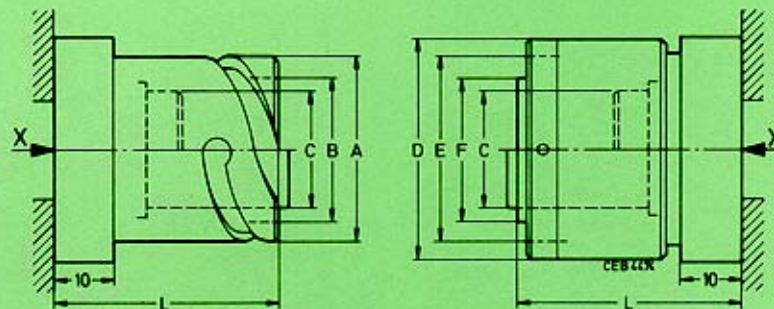

## Assembly shell and insert dimensions

Shell size	A -0,15	A Thread	B +0,3	C +0,3	D max.	E +0,2	E Thread	F -0,2	G	H	L ±0,5	M	N	R ±0,3	S ±0,1	T
10SL	18,2	5/8-24NEF-2A	11,4	10,0	22,8	18,4	5/8-24NEF-2B	11,2	11,35	9,95	33,6	33,65	20,2	25,4	18,2	M 4
12S/12	21,4	3/4-20UNEF-2A	14,2	11,4	25,8	21,6	3/4-20UNEF-2B	13,9	13,35	11,35	33,6	33,65	20,2	28,0	20,6	M 4
14S/14	24,6	7/8-20UNEF-2A	17,3	13,3	29,2	24,8	7/8-20UNEF-2B	17,0	15,85	13,25	33,6	33,65	20,2	30,0	23,0	M 4
16S	27,4	1-20UNEF-2A	20,6	16,4	32,0	27,6	1-20UNEF-2B	20,3	19,65	16,35	33,6	33,65	20,2	32,5	24,6	M 4
16	27,4	1-20UNEF-2A	20,6	16,4	32,0	27,6	1-20UNEF-2B	20,3	19,65	16,35	38,1	38,15	20,0	32,5	24,6	M 4
18	30,8	1 1/8-18UNEF-2A	23,8	19,6	36,5	31,1	1 1/8-18NEF-2B	23,5	21,65	18,90	38,1	38,15	20,0	35,0	27,0	M 4
20	34,2	1 1/4-18UNEF-2A	26,9	23,6	39,9	34,5	1 1/4-18NEF-2B	26,6	26,05	22,80	38,1	38,15	20,0	38,0	29,4	M 4
22	37,4	1 3/8-18UNEF-2A	30,0	26,0	43,1	37,7	1 3/8-18NEF-2B	29,7	28,75	25,00	38,1	38,15	20,0	41,0	31,8	M 4
24	40,9	1 1/2-18UNEF-2A	33,2	29,1	46,6	41,2	1 1/2-18NEF-2B	32,9	32,15	28,10	38,1	38,15	20,0	44,5	34,9	M 4
28	46,7	1 3/4-18NS-2A	38,8	34,7	53,4	47,0	1 3/4-18NEF-2B	38,5	37,35	33,70	38,1	38,15	20,0	50,8	39,7	M 5
32	53,4	2-18NS-2A	45,2	41,0	60,1	53,7	2-18NS-2B	44,8	44,35	40,10	38,7	38,15	20,0	57,0	44,5	M 5
36	59,6	2 1/4-16UN-2A	50,6	46,6	66,3	59,9	2 1/4-16UN-2B	50,2	49,85	45,60	38,7	38,15	20,0	63,5	49,2	M 5

## Assembly shell order nos.

Shell size	Order nos for receptacles VG 95 234 and CA-Bay.	Order nos. for plugs VG 95 234 and CA-Bay.	Order nos. for receptacles with threaded coupling	Order nos. for plugs with threaded coupling
10SL	019-8725-010	249-8589-110	019-8726-010	249-8589-010
12S	019-8725-012	249-8589-112	019-8726-012	249-8589-012
14S	019-8725-014	249-8589-114	019-8726-014	249-8589-014
16S	019-8725-016	249-8589-116	019-8726-016	249-8589-016
16	019-8725-017	249-8589-117	019-8726-017	249-8589-017
18	019-8725-018	249-8589-118	019-8726-018	249-8589-018
20	019-8725-020	249-8589-120	019-8726-020	249-8589-020
22	019-8725-022	249-8589-122	019-8726-022	249-8589-022
24	019-8725-024	249-8589-124	019-8726-024	249-8589-024
28	019-8725-028	249-8589-128	019-8726-028	249-8589-028
32	019-8725-032	249-8589-132	019-8726-032	249-8589-032
36	019-8725-036	249-8589-136	019-8726-036	249-8589-036

## Inserts

## Insert positions

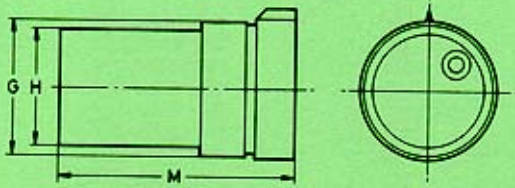

for assembly of pin contacts

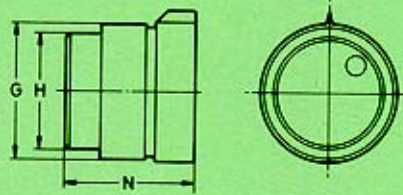
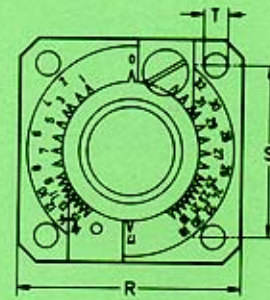

for assembly of socket contacts

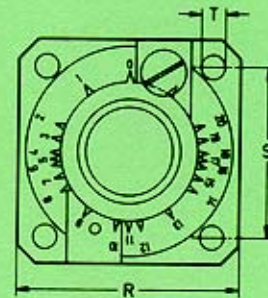

### Insert positions

all positions in degrees°

Shell size	Position															
	1	2	3	4	5	6	7	8	9	10	11	12	13	14	15	16
10SL	-	-	-	-	-	-	-	-	-	-	-	-	-	-	-	-
12/12S	70	100	110	145	215	250	260	290	-	-	-	-	-	-	-	-
14/14S	70	90	100	110	120	145	180	215	240	250	260	270	290	-	-	-
16S	35	70	80	90	95	100	110	145	170	180	190	215	250	260	265	270
16	35	80	90	110	180	250	270	280	325	-	-	-	-	-	-	-
18	35	70	80	90	95	100	110	120	145	170	180	190	215	240	250	260
20	35	45	70	80	90	100	110	130	145	180	215	230	250	260	270	280
22	35	70	80	90	100	110	145	215	250	260	270	280	290	325	-	-
24	30	35	45	80	100	110	250	260	280	315	325	330	-	-	-	-
28	20	30	35	60	70	80	85	90	100	110	145	150	180	210	215	250
32	35	45	70	80	85	100	105	110	125	145	215	235	250	255	260	275
36	35	45	55	60	70	80	90	100	110	115	120	125	130	135	140	145

Shell size	Position																
	17	18	19	20	21	22	23	24	25	26	27	28	29	30	31	32	33
10SL	-	-	-	-	-	-	-	-	-	-	-	-	-	-	-	-	-
12/12S	-	-	-	-	-	-	-	-	-	-	-	-	-	-	-	-	-
14/14S	-	-	-	-	-	-	-	-	-	-	-	-	-	-	-	-	-
16S	280	290	325	-	-	-	-	-	-	-	-	-	-	-	-	-	-
16	-	-	-	-	-	-	-	-	-	-	-	-	-	-	-	-	-
18	265	270	280	290	325	-	-	-	-	-	-	-	-	-	-	-	-
20	290	315	325	-	-	-	-	-	-	-	-	-	-	-	-	-	-
22	-	-	-	-	-	-	-	-	-	-	-	-	-	-	-	-	-
24	-	-	-	-	-	-	-	-	-	-	-	-	-	-	-	-	-
28	260	270	275	280	290	300	325	330	340	-	-	-	-	-	-	-	-
32	280	290	315	325	-	-	-	-	-	-	-	-	-	-	-	-	-
36	180	215	220	225	230	235	240	245	250	260	270	280	290	300	305	315	325

# Assembly aids

## Inserts for assembly of pin and socket contacts

Size	Contact arrangement	for pins	for sockets	Size	Contact arrangement	for pins	for sockets	
10SL	10SL-3	348-8502-000	348-8503-000	18	18-1	348-8512-000	348-8513-000	
	10SL-4	348-8504-000	348-8505-000		18-3	348-8522-162	348-8522-163	
	10SLA-4	348-8522-084	348-8522-085		18-4	348-8522-020	348-8522-021	
12 S	12S-1	348-8522-086	348-8522-087		18-5	348-8522-022	348-0522-023	
	12S-2	348-8522-088	348-8522-089		18-6	348-8522-164	348-8522-165	
	12S-3	348-8522-002	348-8522-003		18-7	348-8522-166	348-8522-165 A	
	12S-4	348-8522-090	348-8522-091		18-8	348-8522-024	348-8522-025	
	12S-6	348-8522-092	348-8522-093		18-9	348-8522-026	348-8522-027	
	12SA-10	348-8522-096	348-8522-097		18-10	348-8522-028	348-8522-029	
					18-11	348-8514-000	348-8515-000	
12	12-5	348-8522-102	348-8522-103		18-12	348-8522-030	348-8522-031	
					18-13	348-8522-032	348-8522-033	
14S	14S-1	348-8522-104	348-8522-105		18-15	348-8522-170	348-8522-171	
	14S-2	348-8522-004	348-8522-105		18-17	348-8522-174	348-8522-175	
	14S-4	348-8522-106	348-8522-107		18-19	348-8522-178	348-8522-179	
	14S-5	348-8522-006	348-8522-007		18-20	348-8522-180	348-8522-181	
	14S-6	348-8506-000	348-8507-000		18-21	348-8522-182	348-8522-183	
	14S-7	348-8522-008	348-8522-009		18-22	348-8522-184	348-8522-185	
	14S-9	348-8522-010	348-8522-011		18-23	348-8522-186	348-8522-187	
	14S-10	348-8522-108	348-8522-109		18-24	348-8522-188	348-8522-189	
	14S-11	348-8522-110	348-8522-111	18-25	348-8522-190	348-8522-191		
	14S-12	348-8522-112	348-8522-113	18-27	348-8522-194	348-8522-195		
	14S-1	348-8522-114	348-8522-115	18-28	348-8522-196	348-8522-197		
	14S-14	348-8522-116	348-8522-117	18A-31	348-8522-206	348-8522-207		
	16S	16S-1	348-8508-000	348-8509-000	20	20-2	348-8516-000	348-8517-000
		16S-4	348-8522-126	348-8522-127		20-3	348-8522-220	348-8522-221
16S-5		348-8522-128	348-8522-129	20-4		348-8522-034	348-8522-035	
16S-8		348-8522-012	348-8522-013	20-6		348-8522-224	348-8522-225	
16S-15		348-8522-134	348-8522-135	20-7		348-8522-036	348-8522-037	
16S-16		348-8522-136	348-8522-137	20-8		348-8518-000	348-8519-000	
16SA-18		348-8522-140	348-8522-141	20-9		348-8522-038	348-8522-039	
16SA-19		348-8522-142	348-8522-143	20-11		348-8522-228	348-8522-229	
16SA-20		348-8522-144	348-8522-145	20-15		348-8522-040	348-8522-041	
16SA-21		348-8522-146	348-8522-147	20-16		348-8522-042	348-8522-043	
16		16-7	348-8522-014	348-8522-015		20-17	348-8522-044	348-8522-045
		16-9	348-8522-016	348-8522-017		20-18	348-8522-236	348-8522-237
	16-10	348-8510-000	348-8511-000	20-19		348-8522-238	348-8517-000 A	
	15-11	348-8522-018	348-8522-019	20-22		348-8522-244	348-8522-245	
	16-12	348-8522-156	348-8522-157	20-23		348-8522-246	348-8517-000 A	
				20-24		348-8522-046	348-8522-047	
				20-25		348-8522-248	348-8522-249	
				20-27		348-8522-048	348-8522-049	
				20-29		348-8522-050	348-8522-051	
				20-30		348-8522-252	348-8522-253	

Size	Contact arrangement	for pins	for sockets	Size	Contact arrangement	for pins	for sockets
20	20-32	348-8522-256	348-8522-257	28	28-5	348-8522-382	348-8522-383
	20-33	348-8522-052	348-8522-053		28-9	348-8522-390	348-8522-391
	20A-9	348-8520-000	348-8521-000		28-10	348-8522-392	348-8522-393
	20A-16	348-8522-260	348-8522-261		28-11	348-8540-000	348-8541-000
	20A-37	348-8522-262	348-8522-263		28-12	348-8522-072	348-8522-073
	20A-48	348-8522-000	348-8523-000		28-13	348-8522-394	348-8522-395
22	22-1	348-8522-266	348-8531-000 A		28-15	348-8522-074	348-8522-075
	22-2	348-8522-054	348-8531-000 A		28-16	348-8522-396	348-8522-397
	22-4	348-8522-270	348-8522-271		28-20	348-8542-000	348-8543-000
	22-5	348-8522-272	348-8522-273		28-21	348-8544-000	348-8545-000
	22-7	348-8522-276	348-8531-000 A		28-22	348-8522-404	348-8522-405
	22-9	348-8522-056	348-8522-057		28-A16	348-8522-076	348-8522-077
	22-12	348-8526-000	348-8527-000		28-A63	348-8546-000	348-8547-000
	22-13	348-8522-284	348-8522-285		28-A65	348-8547-001	348-8547-002
	22-14	348-8528-000	348-8529-000	32	32-1	348-8548-000	348-8549-000
	22-15	348-8522-286	348-8522-287		32-3	348-8551-000	348-8552-000
	22-18	348-8522-292	348-8522-293		32-5	348-8522-078	348-8522-079
	22-19	348-8522-058	348-8522-059		32-6	348-8553-000	348-8554-000
	22-20	348-8522-060	348-8522-061		32-7	348-8555-000	348-8556-000
	22-21	348-8522-294	348-8522-295		32-8	348-8522-080	348-8522-081
	22-22	348-8530-000	348-8531-000		32-9	348-8522-434	348-8522-435
	22-23	348-8524-000	348-8525-000		32-13	348-8522-438	348-8522-439
	22-27	348-8532-000	348-8535-000		32-15	348-8522-442	348-8522-443
	22-28	348-8522-300	348-8522-301		32-16	348-8522-444	348-8522-445
22-30	348-8522-304	348-8522-305	32-17		348-8522-082	348-8522-079 A	
24	24-2	348-8522-062	348-8522-063		32-19	348-8522-446	348-8522-447
	24-3	348-8522-320	348-8522-321		32-20	348-8522-448	348-8522-449
	24-7	348-8522-064	348-8522-063		32A29	348-8522-458	348-8522-459
	24-9 P	348-8522-328	348-8535-000 A	32A30	348-8522-460	348-8522-461	
	24-10	348-8534-000	348-8535-000	32A47	348-8522-466	348-8522-467	
	24-11	348-8536-000	348-8577-000	32A62	348-8522-670	348-8522-471	
	24-12	348-8538-000	348-8539-000	32A69	348-8557-000	348-8558-000	
	24-19	348-8522-340	348-8522-341	32G101	348-8522-480	348-8522-079 A	
	24-20	348-8522-066	348-8522-067	36	36-3	348-8522-486	348-8522-487
	24-22	348-8522-068	348-8535-000 A		36-5	348-8559-000	348-8560-000
	24-28	348-8522-070	348-8522-071		36-6	348-8561-000	348-8560-000 A
	24-24 A 24	348-8522-358	348-8522-359		36-7	348-8522-090	348-8522-491
	24-24 A 35	348-8522-360	348-8522-361		36-8	348-8522-492	348-8522-439
	28	28-1	348-8522-374		348-8522-375	36-10	348-8563-000
28-2		348-8522-376	348-8522-375		36-14	348-8522-496	348-8522-497
28-3		348-8522-378	348-8547-002 A		36-15	348-8522-498	348-8522-499
				36A46	348-8522-518	348-8522-519	



# Wiring instructions

All connectors for which these instructions are applicable are designed to be wired with cables according to MIL-W-5086, TL6145-009 and TL6145-011. Using other wire types please note:

1. wire insulation has to be waterproof (no braid but smooth surface)
2. dimensions have to correspond to following table:

## Conductor dimensions

Contact size	for solder contacts		for crimp contacts	
	AWG	mm <sup>2</sup>	AWG	mm <sup>2</sup>
-/10	-	-	-	0,75-1,0
16S/16/15S/15	16	1,5	16	1,0-1,5
12/25	12	2,5	12	2,5
-/60	-	-	-	6
8/100	8	8,5	8	10
4/160	4	21,5	4	16
0/500	0	53	0	50

## Insulation dimensions

Contact size	Waterproof*		spray waterproof**	
	Ø min.	Ø max.	Ø min.	Ø max.
-/10	1,45	3,0	-	-
16/15	1,6	3,3	-	-
12/25	2,9	4,3	1,6	3,3
-/60	3,5	5,8	2,9	4,3
8/100	4,2	6,5	-	-
4/-	6,9	9,4	4,2	5,7
-/160	6,2	8,5	7,0	9,4
0/500	10,5	14,0	10,6	14,0

\* for VG 95234/CA-Bay.

\*\* for MIL-C-5015/VG 95342

If wires with a smaller insulation diameter are used their diameter has to be increased by using a shrinking tube to correspond with the diameter in the grommet sealing area.

If these requirements are not fulfilled no guarantee can be given for correct connection between the contact and the conductor nor can it be guaranteed that the connector meets its sealing capabilities.

## Wire Stripping

Stripping can be performed either thermally or mechanically.

### Attention:

Do not damage wire or insulation. For solder connections wires have to be pretinned.

Conductor size AWG	mm <sup>2</sup>	contact size AWG/metric	stripping length mm
-	0,75-1,0	10	4,0 <sup>+0,4</sup>
16-22	1,0-1,5	16S/15S/16/15	6,0 <sup>+0,5</sup>
12-14	2,5	12/25	6,0 <sup>+0,5</sup>
8-10	6,0	8/60/100	11,0 <sup>+0,8-0,4</sup>
4-6	16,0	4/160	11,0 <sup>+0,8-0,4</sup>
0-2	50,0	0/500	13,0 <sup>+0,8-0,4</sup>

## Connector Assembly

### Connectors with solder contacts

Solder contacts have been installed, pretinned and solder cups aligned for easier soldering.

### Soldering of wires

Pull wire through all used accessories such as grommet, ferrule, endbell and cable clamp. Make sure that wire is inserted through the appropriate/correct cavity of the grommet. Use Isopropyl alcohol for easier wire insertion through the grommet. Finally, solder conductors to the contacts by use of correct solder tin as well as solder flux. Preferably soldering is started at center contacts and then proceed as shown below:

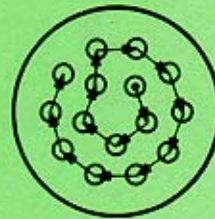

Make sure that soldering is performed as quickly as possible in order to prevent any excessive heat on the insulator to avoid insulator damage. Insert a contact into any empty grommet cavity and seal it with a sealing plug.



### Assembly of Accessories

After soldering, the grommet has to be pushed over the wires in an axial direction until it touches the insulator. The ferrule is then moved over the grommet. Both parts, the grommet as well as the ferrule, are fastened by tightening the endbell.

In order to provide easier assembly, wires, grommets and endbell shall be moistened with Isopropyl alcohol. If necessary, the endbell has to be locked with a locking compound, e.g. Loctite.

### Connectors with Crimp Contacts

Crimp contacts with proper tools only as shown on pages 8ff. For manual crimping use crimp tools together with correct locator. Before crimping, the tool has to be operated (closed) fully and opened again in order to check that the crimp indentors are in correct position for crimping. Then insert contact into the tool with its mating end first. Close the tool partially until the indentors hold the contact in firm position. Insert stripped wire into contact crimp pot applying a slight axial pressure onto the contacts.

When inserting a stranded conductor into a contact please note that all strands are inserted into the crimp pot. The strands must not be twisted too much. Close the tool completely. Its locking mechanism will not allow you to open it, until the crimping operation has been fully performed. Check crimped contact if the conductor is visible through the inspection hole at the bottom of the crimp pot. Crimped contacts may not be bent or damaged in any way. Pull the wire slightly by hand in order to check whether a proper crimp connection has been performed.

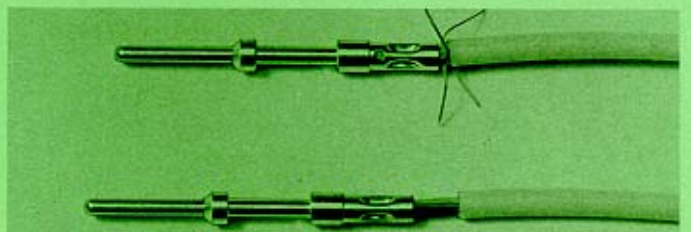

correct

wrong

Contacts of sizes 60/100/8, 160/4 and 500/0 are crimped with the hydraulic tool (see page 10): Insert stripped wire into crimp pot of the contact. Place contact into the crimp die. Make sure that the crimp die is located on center of the contact crimp area. Then operate pump. Both crimp die parts will be pressed together until they touch each other. After the valve is opened the crimped contact can be removed.



### Tensile strength

The wired crimp contact is fixed in a traction device and tested in axial direction. The machine jaws are steadily dispersed by 2,5 to 5 cm per minute.

Contact size metric	AWG	tensile strength N
10	-	75
15 and 15S	16 and 16S	150
25	12	300
60 and 100	8	600
160	4	1200
500	0	2400



correct

### Max. admissible torque for screws at the flanges

Thread	max. admissible torque
M 4	120 Ncm
M 5	200 Ncm



wrong

# Wiring instructions

## Assembly of Contacts

After contacts are crimped, the wires have to be pulled through all accessories used, such as grommets, ferrules, endbells and cable clamps. Please note that each wire is pulled through the correct grommet cavity (same as done on the insulator).

Wire insertion is much easier when using Isopropyl alcohol. Contacts as well as shell with the insulator are dipped into Isopropyl alcohol. Then fix the shell with coupling nut on the assembly adapter (see page 12) and couple with each other. Prior to coupling the threads or the bayonet grooves should be slightly greased according to MIL-C-23827 to ensure smooth coupling. Please do not assemble without assembly adapter or mating connector half.

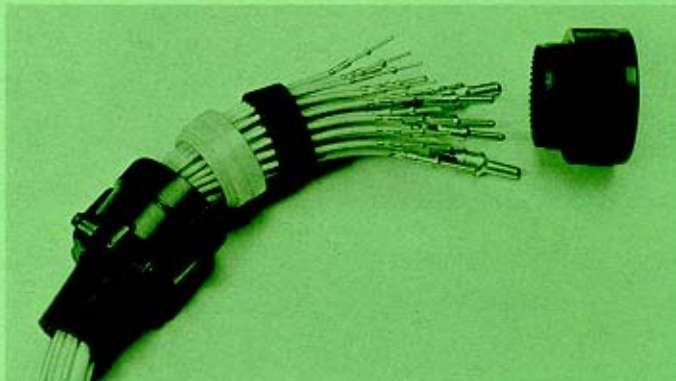

### Insertion of Contacts

Insert contacts by using the correct insertion tool (s. page 11). Place wired contact into insertion tool in a way that contact, wire and insertion tool are axial to each other. The insertion tool has to butt against the connector shoulder.

Now push the contact, moistened with Isopropyl alcohol, into the insulator by applying slow, continuous pressure, until it snaps into its position. During this operation hold tool vertically to the insulator surface.

**Note:**  
Assemble socket contacts sizes 15S/16S/15/16/12 and 25 only by using guide pins (see page 11). Contact insertion is preferably started in the center of the insulator.

After insertion operation remove the insertion tool cautiously. Avoid any movement of the tool during the insertion/extraction process which is not axial to the contact/insulator.

Also insert unwired contacts and close the grommet cavity with a sealing plug.

**Please note:**  
do not install damaged or bent contacts.

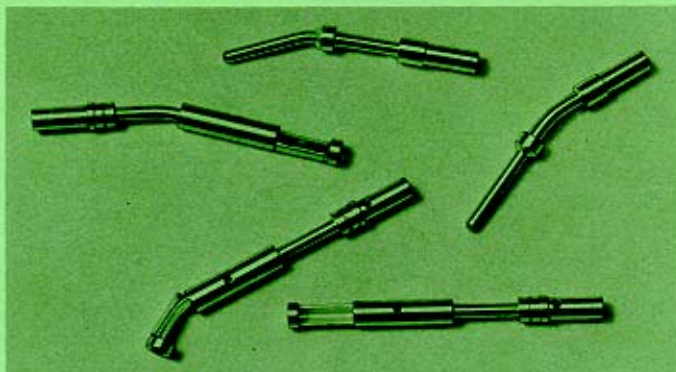

If a contact is damaged during the insertion this contact has to be removed (see Removal of Contacts on this page). A new contact has to be installed. If the insulator or the grommet is damaged they must be replaced. After insertion of the contacts, check connector on the mating side to ensure all contacts are on the same level.



### Removal of Contacts

All accessories are removed in reversed direction as described on page 16. They are pushed back over the wires of the cable harness.

Remove the contact by using the correct tool as follows:

Place tool from the mating side parallel to their axis over the socket or pin contact. Apply smooth and continuous pressure towards the rear end of the connector to push contact out of the insulator. The operation is terminated as soon as the shoulder of the tool butts against the front of the insulator. Then pull tool carefully out of the connector.



### Free connectors with HF-Shielding

**Note:**  
The grounding finger ring may not be bent nor damaged during wiring.

This is valid especially when the coupling nut has been removed for assembly of contacts and is pushed on again.

The risk of damage will be avoided by using our assembly aids (see pages 12–15).

# Wiring Instructions

## Shielding braid

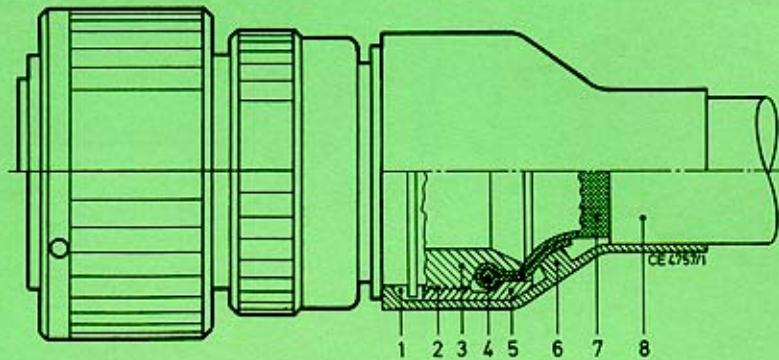

### Fixing of shielding braid to connectors with DZ adapter

- Loosen lock nut (5). Slide heat shrink component (6) and lock nut (5) over cable
- Push shielding braid (7) onto endbell (3) and over thread (2)
- Fasten shielding braid (7) into rounded groove by means of baling wire
- Fold back protruding shielding braid on cone
- Screw lock nut (5) onto endbell (3). The folded back shielding braid protrudes under the tightened lock nut
- Shrink heat shrink component (6) according to manufacturers instructions. (End of heat shrink component to be located in square groove (1))

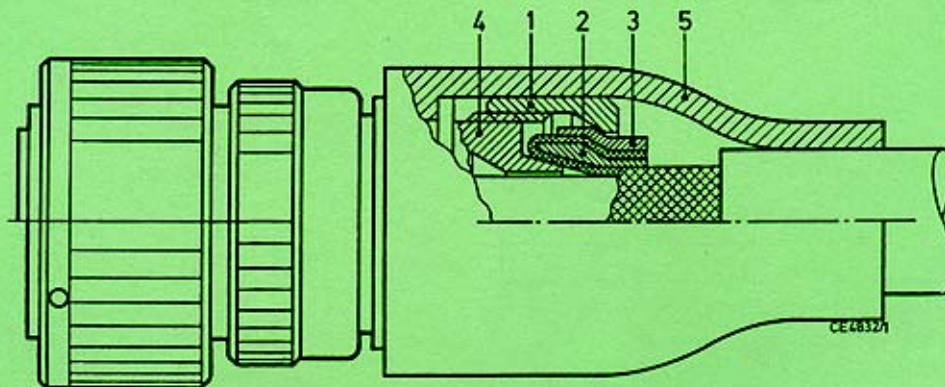

### Fixing of shielding braid to connectors (double termination)

- Loosen coupling nut (1) at the rear
- Slide inner and outer cone over shielding braid
- Slide first ring (2) over shielding braid until stop (figure a)
- Fold shielding braid back over ring (2). Afterwards slide second ring (3) over shielding braid until stop and first ring (2 - figure b)
- Trim shielding braid flush with ring (3)
- Screw coupling nut (1) to the rear of the adapter (4 - figure b)
- Shrink heat shrink component (5) according to manufacturers instructions

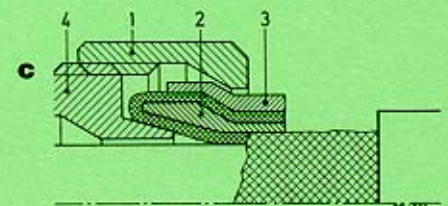
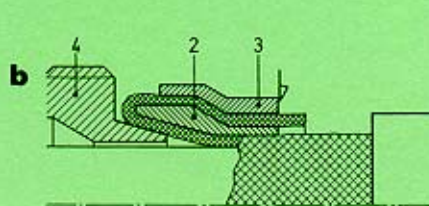
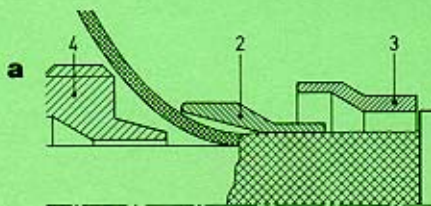

# Wiring Instructions

---

## Shielding braid

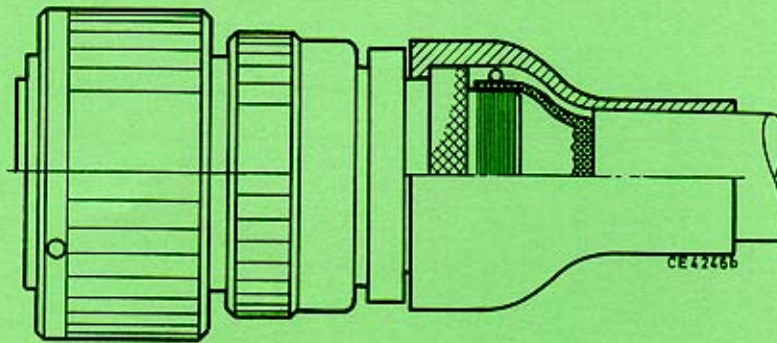

Prior to contact termination push all connector components including the Tinel Lock\* shrink ring adapter in correct order over the cable to be terminated. Wire contacts and insert into connector. Screw adapter to connector housing.

Position shielding braid on termination diameter of adapter and fix by means of the Tinel Lock shrink ring. Eventually trim end of shielding braid.

**Note**

Locate Tinel Lock shrink ring approximately in the middle of the termination area.

Shrink on Tinel Lock shrink ring by resistance heating. Seize shrink ring with hand tool electrodes. Close tool by the action point of the switch and hold in place until heat indicator colours change from green to black. Remove tool and check termination area:

- position of Tinel Lock shrink ring?
- are both colour dots black?

Finally attach shrink boot.

\* Tinel-Lock is a trademark of Raychem

# Wiring instructions

## Torque wrench system CTW 17

The torque wrench system **CTW 17** consists of torque wrench incl. display, connector holder and backshell assembly wrench.

### Operation instructions

Select proper connector holder and put it on torque wrench.  
Set desired torque as follows:

- turn bezel (1) clockwise until light signal is on.
- continue until main pointer (2) together with memory pointer (3) is at desired torque level.
- turn bezel (1) now counter clockwise until the main pointer is aligned with "0" on scale.

Torque wrench is now ready for operation.

Backshell assembly wrench to be used as shown; tighten backshell until set torque is rechecked and light signal is on.

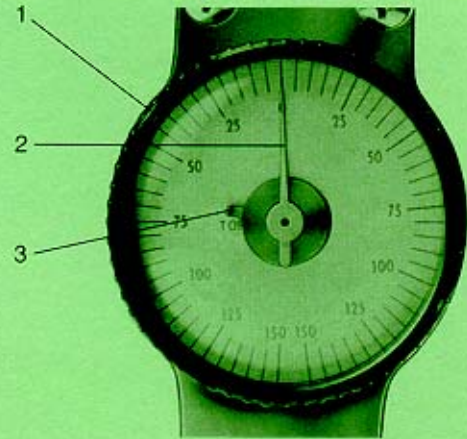

### Caution:

Do not apply torque in excess of signal setting. Excess torque will cause signal pointer to reset and give erroneous reading.

### Order references

Torque wrench **CTW 17**

Connector holder

**CTWH – CA 10 P**

P – insert for plug holder  
R – insert for receptacle holder

Shell size

Series  
CA 10...36  
(also available for MS/CA-B)

Connector holder

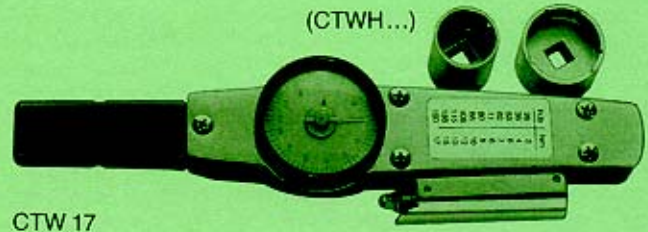

CTW 17

Torque key

**CTWA 10**  
**CTWA 12**  
**CTWA 14**  
**CTWA 16**

**CTWA 18**  
**CTWA 20**  
**CTWA 22**  
**CTWA 24**

**CTWA 28**  
**CTWA 32**  
**CTWA 36**

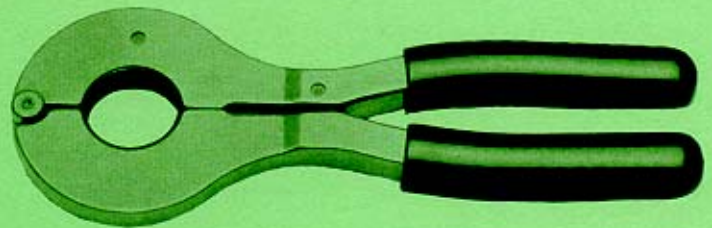

CTWA...

Spare parts

Insert pads **CTWA-PR 24**

### Torque for endbells

Shell size	Admissible torque (Nm)
10 SL	3
12	4
14	5.1
16	7
18	8
20	9
22	10.6
24	12.9
28	16.7
32	18.1
36	23.9

### Torque for hex nut

Shell size	max. admissible torque (Nm)
8	10
10	16
12	20
14	20
16	30
18	30
20	30
22	40
24	40
28	50
32	50
36	50

## Useful Hints

Keep hands, working place and connectors clean and free of any grease.

Check tools, connectors, accessories, cable sizes and other aids for correct part number and size.

### Cable/wire cutting and stripping

Cut wire/cable in a way that a proper and even surface is achieved. Avoid indents, marks, or similar in the cutting area. During stripping of individual wires observe the stripping length (see page 16) depending on contact size.

Prevent any damage of individual strands.

For solder connections pretin the conductor over the complete stripping length.

Keep time of soldering the conductors to contacts already installed in the insulator as short as possible in order to prevent any damage to the insulator which may be caused by over-heating.

To obtain good crimp connection please follow these rules:

- a) Use correct crimp tool with correct locator
- b) When terminating contacts sizes 60/100, 160 and 500 with the hydraulic crimp tool finalize crimping operation without interruption! Do not dislocate the dies for the hexagonal crimp.
- c) Use correct insertion tool for individual contacts
- d) Stripped conductors have to be crimped in a proper way.

The following simple tests can be made:

Visual:

Contacts are damaged during crimping (torn, bent, etc.)  
All wire strands must be inserted in the contact.

Mechanical:

Pull the terminated wire to check if crimp connection is properly made.

Insert contacts straight into insulator

Do not insert damaged contacts

Maintain steady pressure when contacts are inserted

Do not use damaged insulators or grommets

Before insertion of wired contacts slide hardware (grommet, endbell or cable clamp etc.) in proper order over the wire bundle.

Please assure that the correct conductor is inserted into the correct cavity of the grommet.

Isopropyl alcohol facilitates insertion of cable into grommet.

Apply Isopropyl alcohol to the appropriate insulator cavity prior to insertion of contact.

Inspect visually, if all socket or pin contacts are inserted properly, i.e. whether the mating ends of the contacts are all on same level.

Mate shells resp. barrels with coupling nuts in correct assembly adapter.

Do not harness without using assembly adapters or mating connectors.

If required, lock endbell with Loctite or other locking compound. Loctite is to be stored at room temperature preferably below 20°C.

Insert contacts from the rear and release them from the mating face of the connector.

Extract contact only with the correct tool.

Note: according to weight and tension (vibration, acceleration) the cable has to be seized and fixed at the suitable place.

## Adjustment and Test Gauges

### Test gauges for hand crimp tools

1. Test gauge for hand crimp tools MS 3191-A		
Die	MS designation	MS3196-1
	Cannon order reference	604 697
Test gauge	MS designation	MS3196-3
	Cannon order reference	600 061
Test set includes die and test gauge		
	MS designation	MS3196-2
	Cannon order reference	611 965
2. Test gauge for hand crimp tool M22520/1-01		
	MS designation	M22520/3-1
	Cannon order reference	600 064

### Adjustment gauges for pneumatic crimp tools 612 871 and 612 141

Adjustment gauges for contacts sizes 10, 16S/15S, 16/15 according to VG 95234	Cannon order reference	600 047
Adjustment gauges for contacts sizes 12/15 according to VG 95234	Cannon order reference	600 046

To maintain the crimp quality we recommend the following tests:

#### Extraction test

Check the extraction force of the conductor from the crimp pot once per week. Compare the values obtained with the minimum extraction forces mentioned in chart on page 17.

#### Check of crimp tools

When obtaining negative extraction values, please check hand and pneumatic crimp tools with gauges mentioned in the left column.

In addition an optical check of the locators has to be made.

The hydraulic crimp tool dies have to be checked if jaws close parallelly. Then the wrench width has to be measured and compared to chart on page 10.

We recommend to perform these tests after 10.000 crimps or once per month.

#### Cross sections

The enlargement of cross sections enables for final conclusion of the quality of the crimp area.

We always recommend to do this when using a new cable type.

# Product Safety Information

**THIS NOTE SHOULD BE READ IN CONJUNCTION WITH THE PRODUCT DATA SHEET/CATALOGUE. FAILURE TO OBSERVE THE ADVICE IN THIS INFORMATION SHEET AND THE OPERATING CONDITIONS SPECIFIED IN THE PRODUCT DATA SHEET/CATALOGUE COULD RESULT IN HAZARDOUS SITUATIONS.**

## 1. MATERIAL CONTENT AND PHYSICAL FORM

Electrical connectors do not usually contain hazardous materials. They contain conducting and non-conducting materials and can be divided into two groups.

a) Printed circuit types and low cost audio types which employ all plastic insulators and casings.

b) Rugged, Fire Barrier and High Reliability types with metal casings and either natural rubber, synthetic rubber, plastic or glass insulating materials.

Contact materials vary with type of connector and also application and are usually manufactured from either copper, alloys, nickel, alumel, chromel or steel. In special applications, other alloys may be specified.

## 2. FIRE CHARACTERISTICS AND ELECTRIC SHOCK HAZARD

**There is no fire hazard when the connector is correctly wired and used within the specified parameters.**

**Incorrect wiring or assembly of the connector or careless use of metal tools or conductive fluids, or transit damage to any of the component parts may cause electric shock or burns. Live circuits must be broken by separating mated connectors as this may cause arcing, ionisation and burning.**

Heat dissipation is greater at maximum resistance in a circuit. Hot spots may occur when resistance is raised locally by damage, e.g. cracked or deformed contacts, broken strands of wire. Local overheating may also result from the use of the incorrect application tools or from poor quality soldering or slack screw terminals. Overheating may occur if the ratings in the Product Data Sheet/Catalogue are exceeded and can cause breakdown of insulation and hence electric shock.

If heating is allowed to continue it intensifies by further increasing the local resistance through loss of temper of spring contacts, formation of oxide film on contacts and wires, and leakage currents through carbonisation of insulation and tracking paths. Fire can then result in the presence of combustible materials and this may release noxious fumes. Overheating may not be visually apparent. Burns may result from touching overheated components.

## 3. HANDLING

Care must be taken to avoid damage to any component parts of electrical connectors during installation and use. Although there are normally no sharp edges, care must be taken when handling certain components to avoid injury to fingers.

Electrical connectors may be damaged in transit to the customers, and damage may result in creation of hazards. Products should therefore be examined prior to installation/use and rejected if found to be damaged.

## 4. DISPOSAL

Incineration of certain materials may release noxious or even oxid fumes.

## 5. APPLICATION

Connectors with exposed contacts should not be selected for use on the current supply side of an electrical circuit, because an electric shock could result from touching exposed contacts on an unmated connector. Voltages in excess of 30 V ac or 42.5 V dc are potentially hazardous and care should be taken to ensure that such voltages can not be transmitted in any way to exposed metal parts of the connector body. The connector and wiring should be checked, before making live, to have no damage to metal parts of insulators, no solder blobs, loose strands, conducting lubricants, swarf, or any other undersized conducting particles. Insulation resistance should be checked to make certain that no low resistance joints or spurious conducting path are existing between contacts and exposed metal parts of the connector body. Further the contact resistance of the connectors should be measured within the electrical circuit in order to identify high

resistances which result in excessive connector heating.

Always use the correct application tools as specified in the Data Sheet/Catalogue.

Do not permit untrained personnel to wire, assemble or tamper with connectors.

For operation voltage please see appropriate national regulations

## IMPORTANT GENERAL INFORMATION.

1. Air and creepage paths/Operating voltage  
The admissible operating voltages depend on the individual applications and the valid national and other applicable safety regulations.

For this reason the air and creepage path data are only reference values. Observe reduction of air and creepage paths due to PC board and/or harnessing.

## 2. Temperature

All information given are temperature limits. The operation temperature depends on the individual application.

## 3. Other important information

Cannon continuously endeavours to improve their products. Therefore, Cannon products may deviate from the description, technical data and shape as shown in this catalogue and data sheets.

## 4. Harnessing and Assembly Instructions

If applicable, our special harnessing and/or assembly instruction has to be adhered to. This is provided at request.

## Legal Information

ITT Cannon manufactures the highest quality products available in the marketplace; however these products are intended to be used in accordance with the specifications in this catalog. Any use or application that deviates from stated operating specifications is not recommended and may be unsafe. No information and data contained in this catalog shall be construed to create any liability on the part of ITT Cannon. Any new issue of this catalog shall automatically invalidate and supersede any and all previous issues. **A limited warranty applies to ITT Cannon products. Except for obligations assumed by ITT Cannon under this warranty, ITT Cannon shall not be liable for any loss, damage, cost of repairs, incidental or consequential damages of any kind, whether or not based on express or implied warranty, contract, negligence or strict liability arising in connection with the design, manufacture, sale, use or repair of the products.** Product availability, prices and delivery dates are exclusively subject to our respective order confirmation form; the same applies to orders based on development samples delivered. This catalog is not be construed as an offer. It is intended merely as an invitation to make an offer. By this publication, ITT Cannon does not assume responsibility or any liability for any patent infringements or other rights of third parties which may result from its use. Reprinting this catalog is generally permitted, indicating the source. However, ITT Cannon's prior consent must be obtained in all cases.

Cannon is a trademark of ITT Industries, Inc



---

## ITT Cannon Worldwide Facilities

---

**Austria**

Afrikanergasse 3  
1020 Vienna  
FAX: (1) 2160948 PH: (1) 2160947

---

**Benelux**

Rue Col. Bourg Str. 105A  
1140 Brussels, Belgium  
FAX: (02) 726 92 01 PH: (02) 726 75 94

---

**China**

No. 24, 2 Block  
Taohuawu New District  
Zhenjiang, Jiangsu  
P.R.C.  
FAX: 511 4428616 PH: 511 4427111

---

**Denmark**

Park Allé 287 A  
2605 Brøndby  
FAX: 43 43 58 58 PH: 43 45 52 88

---

**Finland**

Sarkatie 2  
01720 Vantaa  
FAX: 3589 7003 9180 PH: 3589 7003 9188

---

**France**

2, Ave Sablons Bouillants, B.P. 133  
77109 Meaux  
FAX: (1) 64 33 16 82 PH: (1) 64 33 48 05

---

**Germany**

Postfach 11 20, 71365 Weinstadt  
Cannonstrasse 1, 71384 Weinstadt  
FAX: (07151) 699217 PH: (07151) 699-0

---

**Hong Kong**

901 New World Office Building  
West Wing, Salisbury Road  
Kowloon  
FAX: (852) 2732-2919 PH: (852) 2732-2720

---

**Israel**

Aro-Tech  
14 Hamashot St., P.O.B. 4447  
75143 Rishon Lezion  
FAX: (972) 39513101 PH: (972) 39513099

---

**Italy**

Via Panzeri 10  
20123 Milano  
FAX: (02) 8372036 PH: (02) 581801

---

**Japan**

5362-1, 5-chome, Hibarigaoka  
Zama-shi, Kanagawa 228  
FAX: 0462-57-1680 PH: 0462-57-2010

---

**Korea**

620, Changkang Bldg.  
#22, Dohwa-dong, Mapo-ku  
Seoul  
FAX: (02) 717 7330 PH: (02) 702 7111

---

**Norway**

Frank El-Mek A/S  
Postboks 42, Smestad  
0309 Oslo  
FAX: 22 50 32 05 PH: 22 50 70 20

---

**Spain**

Edificio Italia 1ª planta  
Parque Empresarial San Fernando  
San Fernando de Henares  
28831 Madrid  
FAX: (34) 1 656 15 83 PH: (34) 1 656 03 11

---

**Sweden**

Norr Mälärstrand 64  
Jaktvarvet 1  
11235 Stockholm  
FAX: (46) 8 650 0072 PH: (46) 8 650 0071

---

**Switzerland**

Herzogenmühle 18  
8304 Wallisellen  
FAX: (01) 830-3104 PH: (01) 830-3888, 830-3613

---

**United Kingdom**

Jays Close, Viabes Estate  
Basingstoke Hants RG22 4BW  
FAX: (01256) 323356 PH: (01256) 331200

---

**United States**

666 E. Dyer Road  
Santa Ana, CA 92705-5612  
FAX: 1.714-754-2142 PH: 1.714-557-4700

---

**INTERNET**

<http://www.ittcannon.com>

---