



Chipsmall Limited consists of a professional team with an average of over 10 year of expertise in the distribution of electronic components. Based in Hongkong, we have already established firm and mutual-benefit business relationships with customers from,Europe,America and south Asia,supplying obsolete and hard-to-find components to meet their specific needs.

With the principle of “Quality Parts,Customers Priority,Honest Operation,and Considerate Service”,our business mainly focus on the distribution of electronic components. Line cards we deal with include Microchip,ALPS,ROHM,Xilinx,Pulse,ON,Everlight and Freescale. Main products comprise IC,Modules,Potentiometer,IC Socket,Relay,Connector.Our parts cover such applications as commercial,industrial, and automotives areas.

We are looking forward to setting up business relationship with you and hope to provide you with the best service and solution. Let us make a better world for our industry!



Contact us

Tel: +86-755-8981 8866 Fax: +86-755-8427 6832

Email & Skype: info@chipsmall.com Web: www.chipsmall.com

Address: A1208, Overseas Decoration Building, #122 Zhenhua RD., Futian, Shenzhen, China



CFRB201-G Thru. CFRB207-G

Reverse Voltage: 50 to 1000 Volts

Forward Current: 2.0 Amp

RoHS Device

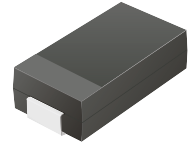

Features

- Ideal for surface mount applications.
- Easy pick and place.
- Plastic package has Underwriters Lab. flammability classification 94V-0.
- Fast recovery time: 150~500nS.
- Low leakage current.

Mechanical data

- Case: JEDEC DO-214AA, molded plastic.
- Terminals: solderable per MIL-STD-750, method 2026.
- Polarity: Color band denotes cathode end.
- Approx. weight: 0.093 grams

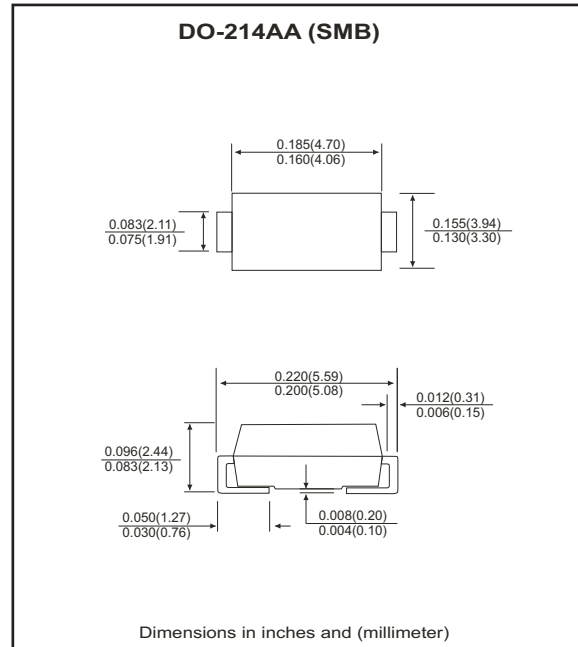

Maximum Ratings and Electrical Characteristics

| Parameter | Symbol | CFRB 201-G | CFRB 202-G | CFRB 203-G | CFRB 204-G | CFRB 205-G | CFRB 206-G | CFRB 207-G | Units |
|--|-----------------|-------------|------------|------------|------------|------------|---------------|------------|-------------|
| Max. repetitive peak reverse voltage | V_{RRM} | 50 | 100 | 200 | 400 | 600 | 800 | 1000 | V |
| Max. DC blocking voltage | V_{DC} | 50 | 100 | 200 | 400 | 600 | 800 | 1000 | V |
| Max. RMS voltage | V_{RMS} | 35 | 70 | 140 | 280 | 420 | 560 | 700 | V |
| Peak surge forward current, 8.3ms single half sine-wave superimposed on rate load (JEDEC method) | I_{FSM} | 50 | | | | | | | A |
| Max. average forward current | I_o | 2.0 | | | | | | | A |
| Max. instantaneous forward voltage at 2.0A | V_F | 1.3 | | | | | | | V |
| Reverse recovery time | T_{rr} | 150 | | | | 250 | 500 | | nS |
| Max. DC reverse current at $T_A=25^{\circ}C$ rated DC blocking voltage $T_A=125^{\circ}C$ | I_R | 5.0 | | | | | 50 | | μA |
| Max. thermal resistance (Note 1) | $R_{\theta JL}$ | 20 | | | | | $^{\circ}C/W$ | | |
| Max. operating junction temperature | T_J | 150 | | | | | | | $^{\circ}C$ |
| Storage temperature | T_{STG} | -55 to +150 | | | | | | | $^{\circ}C$ |

Notes: 1. Thermal resistance from junction to lead mounted on P.C.B. with 8.0x8.0 mm square² (0.13mm thick) land area.

RATING AND CHARACTERISTIC CURVES (CFRB201-G thru CFRB207-G)

Fig.1 Reverse Characteristics

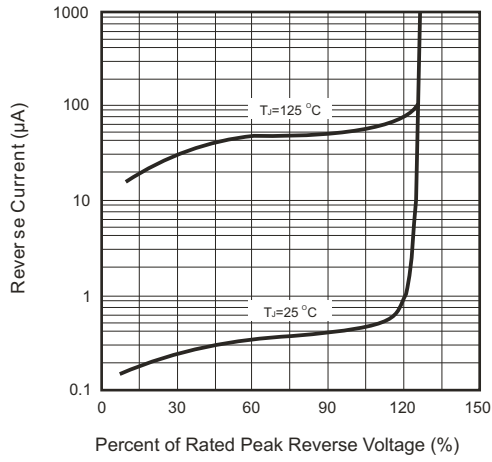

Fig.2 Forward Characteristics

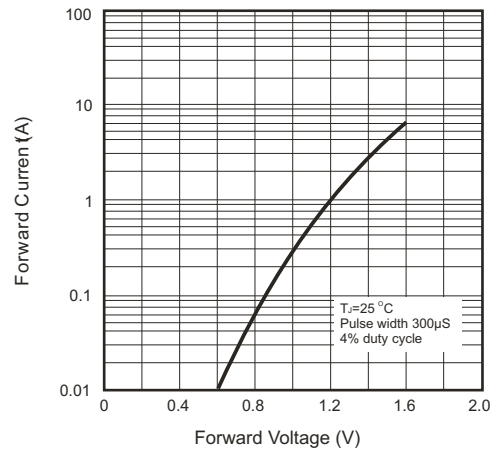

Fig.3 Junction Capacitance

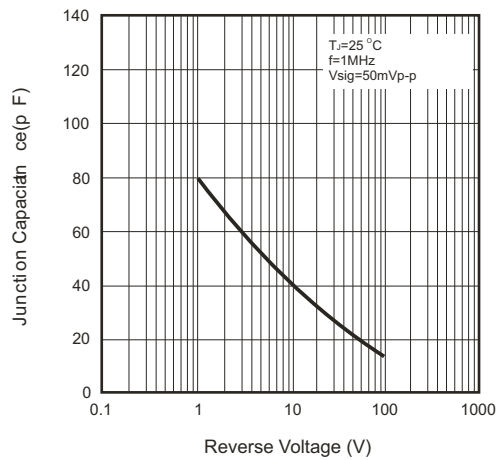

Fig.4 Non-repetitive Forward Surge Current

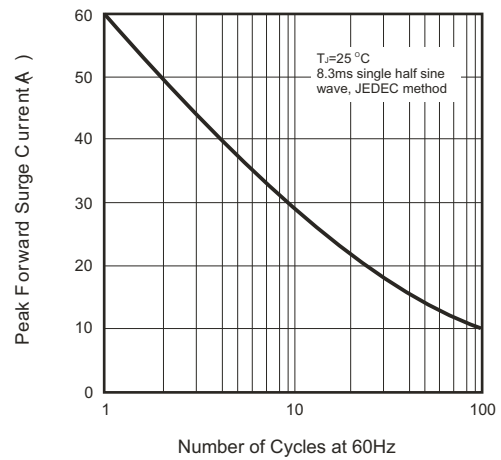

Fig.5 Test Circuit Diagram and Reverse Recovery Time Characteristics

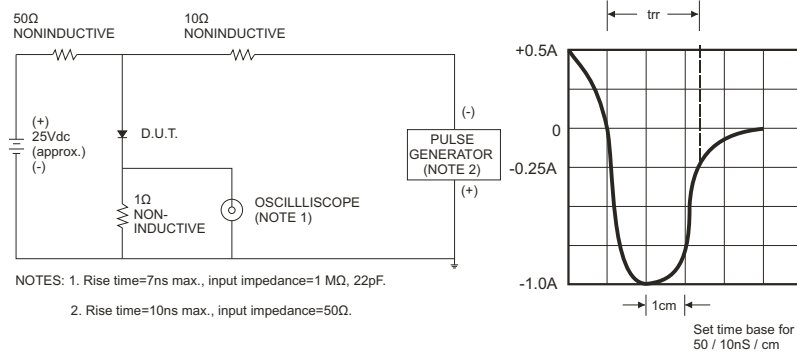

Fig.6 Current Derating Curve

