



Chipsmall Limited consists of a professional team with an average of over 10 year of expertise in the distribution of electronic components. Based in Hongkong, we have already established firm and mutual-benefit business relationships with customers from,Europe,America and south Asia,supplying obsolete and hard-to-find components to meet their specific needs.

With the principle of “Quality Parts,Customers Priority,Honest Operation,and Considerate Service”,our business mainly focus on the distribution of electronic components. Line cards we deal with include Microchip,ALPS,ROHM,Xilinx,Pulse,ON,Everlight and Freescale. Main products comprise IC,Modules,Potentiometer,IC Socket,Relay,Connector.Our parts cover such applications as commercial,industrial, and automotives areas.

We are looking forward to setting up business relationship with you and hope to provide you with the best service and solution. Let us make a better world for our industry!



Contact us

Tel: +86-755-8981 8866 Fax: +86-755-8427 6832

Email & Skype: info@chipsmall.com Web: www.chipsmall.com

Address: A1208, Overseas Decoration Building, #122 Zhenhua RD., Futian, Shenzhen, China



CGH40045

45 W, DC - 4 GHz RF Power GaN HEMT

Cree's CGH40045 is an unmatched, gallium nitride (GaN) high electron mobility transistor (HEMT). The CGH40045, operating from a 28 volt rail, offers a general purpose, broadband solution to a variety of RF and microwave applications. GaN HEMTs offer high efficiency, high gain and wide bandwidth capabilities making the CGH40045 ideal for linear and compressed amplifier circuits. The transistor is available in a flange and pill package.

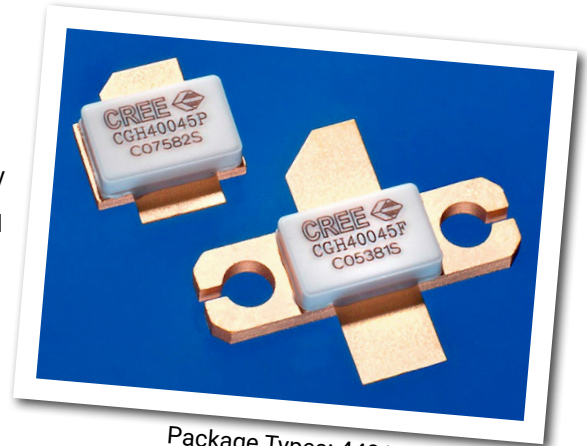

Package Types: 440193 & 440206
 PN's: CGH40045F & CGH40045P

FEATURES

- Up to 4 GHz Operation
- 16 dB Small Signal Gain at 2.0 GHz
- 12 dB Small Signal Gain at 4.0 GHz
- 55 W Typical P_{SAT}
- 55 % Efficiency at P_{SAT}
- 28 V Operation

APPLICATIONS

- 2-Way Private Radio
- Broadband Amplifiers
- Cellular Infrastructure
- Test Instrumentation
- Class A, AB, Linear amplifiers suitable for OFDM, W-CDMA, EDGE, CDMA waveforms

Absolute Maximum Ratings (not simultaneous) at 25°C Case Temperature

Parameter	Symbol	Rating	Units	Conditions
Drain-Source Voltage	V_{DSS}	84	Volts	25°C
Gate-to-Source Voltage	V_{GS}	-10, +2	Volts	25°C
Storage Temperature	T_{STG}	-65, +150	°C	
Operating Junction Temperature	T_J	225	°C	
Maximum Forward Gate Current	I_{GMAX}	15	mA	25°C
Maximum Drain Current ¹	I_{DMAX}	6	A	25°C
Soldering Temperature ²	T_S	245	°C	
Screw Torque	τ	80	in-oz	
Thermal Resistance, Junction to Case ³	R_{JJC}	2.8	°C/W	85°C
Case Operating Temperature ^{3,4}	T_C	-40, +150	°C	

Note:

¹ Current limit for long term, reliable operation

² Refer to the Application Note on soldering at www.cree.com/RF/Document-Library

³ Measured for the CGH40045F at $P_{DISS} = 56W$.

⁴ See also, the Power Dissipation De-rating Curve on Page 8.

Electrical Characteristics ($T_C = 25^\circ C$)

Characteristics	Symbol	Min.	Typ.	Max.	Units	Conditions
DC Characteristics¹						
Gate Threshold Voltage	$V_{GS(th)}$	-3.8	-3.0	-2.3	V_{DC}	$V_{DS} = 10 V, I_D = 14.4 mA$
Gate Quiescent Voltage	$V_{GS(Q)}$	-	-2.7	-	V_{DC}	$V_{DS} = 28 V, I_D = 400 mA$
Saturated Drain Current ²	I_{DS}	11.6	14.0	-	A	$V_{DS} = 6.0 V, V_{GS} = 2.0 V$
Drain-Source Breakdown Voltage	V_{BR}	120	-	-	V_{DC}	$V_{GS} = -8 V, I_D = 14.4 mA$
RF Characteristics³ ($T_C = 25^\circ C, F_0 = 2.5 GHz$ unless otherwise noted)						
Small Signal Gain	G_{SS}	12.5	14	-	dB	$V_{DD} = 28 V, I_{DQ} = 400 mA$
Power Output ⁴	P_{SAT}	40	55	-	W	$V_{DD} = 28 V, I_{DQ} = 400 mA$
Drain Efficiency ⁵	η	45	55	-	%	$V_{DD} = 28 V, I_{DQ} = 400 mA, P_{OUT} = P_{SAT}$
Output Mismatch Stress	VSWR	-	-	10 : 1	Ψ	No damage at all phase angles, $V_{DD} = 28 V, I_{DQ} = 400 mA,$ $P_{OUT} = 45 W CW$
Dynamic Characteristics						
Input Capacitance	C_{GS}	-	19.0	-	pF	$V_{DS} = 28 V, V_{GS} = -8 V, f = 1 MHz$
Output Capacitance	C_{DS}	-	5.9	-	pF	$V_{DS} = 28 V, V_{GS} = -8 V, f = 1 MHz$
Feedback Capacitance	C_{GD}	-	0.8	-	pF	$V_{DS} = 28 V, V_{GS} = -8 V, f = 1 MHz$

Notes:

¹ Measured on wafer prior to packaging.

² Scaled from PCM data.

³ Measured in CGH40045F-AMP

⁴ P_{SAT} is defined as $I_G = 1.08 mA$.

⁵ Drain Efficiency = P_{OUT} / P_{DC}

Typical Performance

Simulated Small Signal Gain and Input Return Loss of the CGH40045F-AMP vs Frequency
 $V_{DD} = 28\text{ V}, I_{DQ} = 400\text{ mA}$

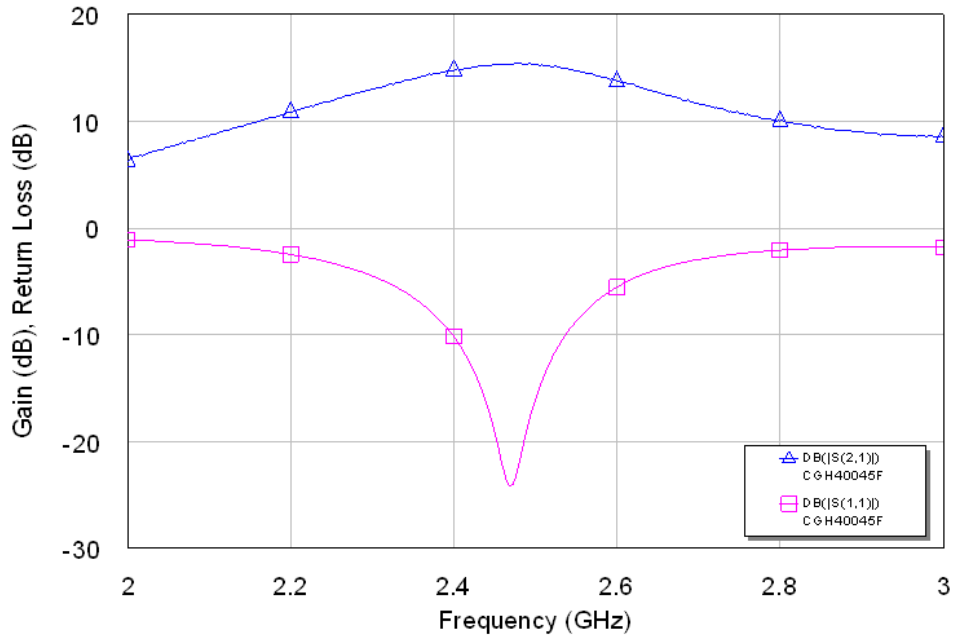

Gain, Efficiency, and Output Power vs Frequency measured in Amplifier Circuit CGH40045F-AMP
 $V_{DD} = 28\text{ V}, I_{DQ} = 400\text{ mA}$

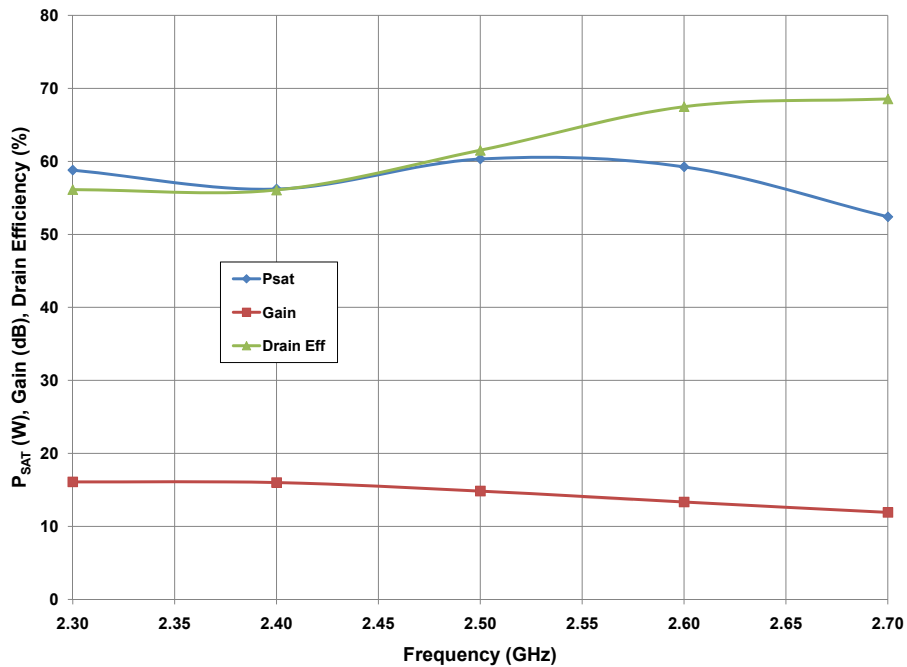

Typical Performance

Gain and Efficiency vs Output Power
 measured in Amplifier Circuit CGH40045F-AMP
 $V_{DD} = 28\text{ V}$, $I_{DQ} = 400\text{ mA}$, Freq = 2.5 GHz

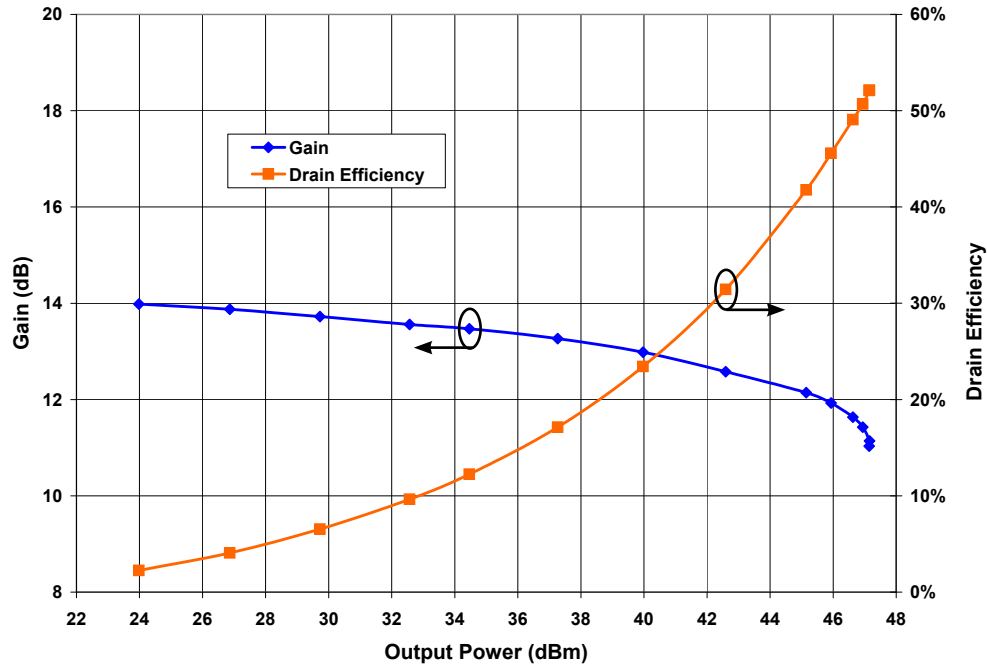

Single Tone CW Output Power vs Input Power
 measured in Amplifier Circuit CGH40045F-AMP
 $V_{DD} = 28\text{ V}$, $I_{DQ} = 400\text{ mA}$

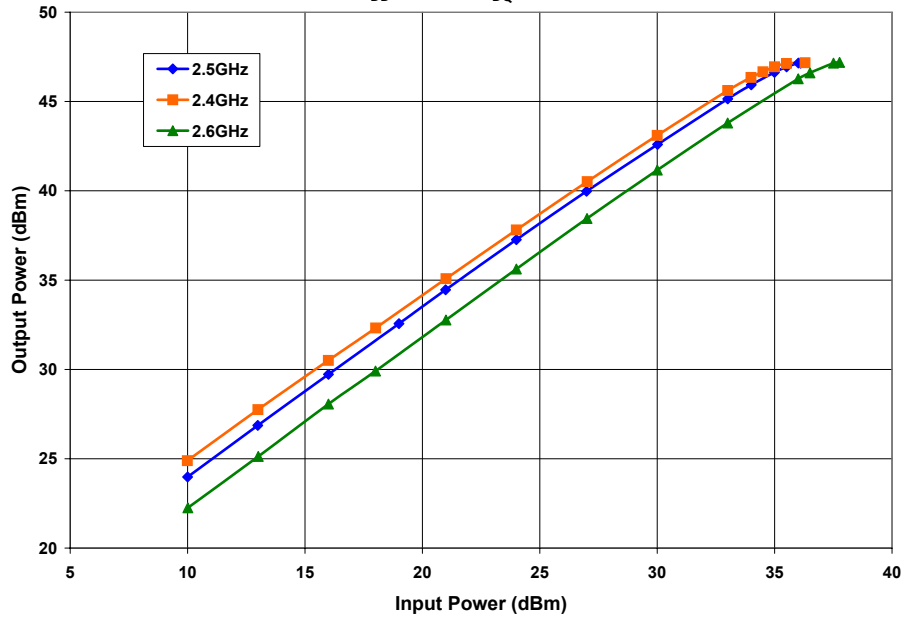

Typical Performance

**Pulsed Gain and Output Power vs Input Power
measured in Amplifier Circuit CGH40045F-AMP**

$V_{DD} = 28\text{ V}$, $I_{DQ} = 800\text{ mA}$, Freq = 3.6 GHz, Pulse Width=200 μs , 10% Duty Cycle

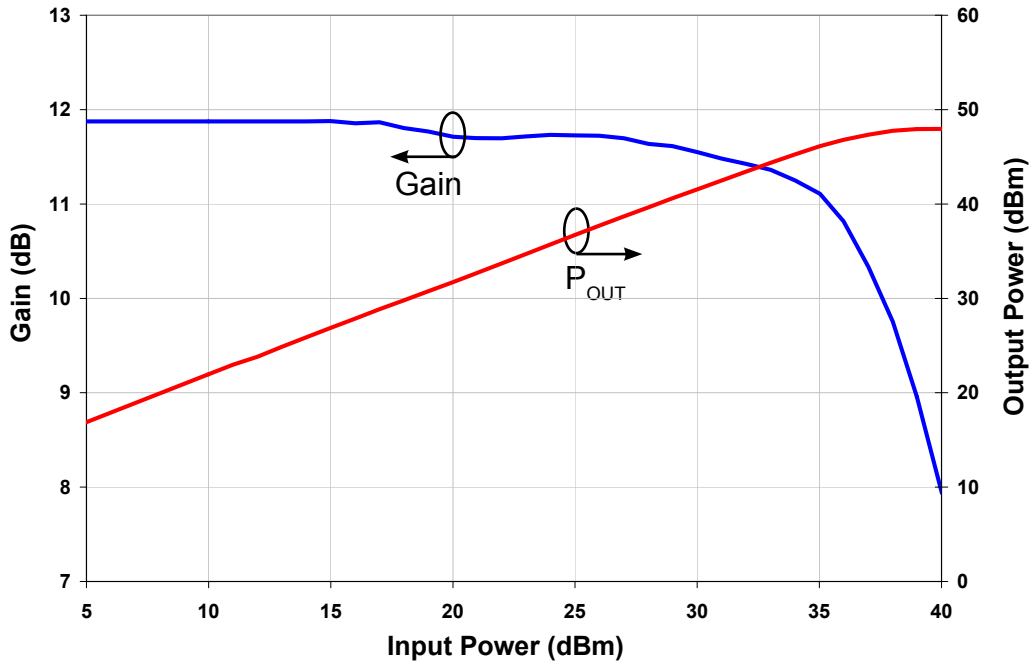

**Single Tone CW Gain, Efficiency, and Output Power vs Input Power
measured in Amplifier Circuit CGH40045F-AMP**

$V_{DD} = 28\text{ V}$, $I_{DQ} = 800\text{ mA}$, Freq = 3.6 GHz

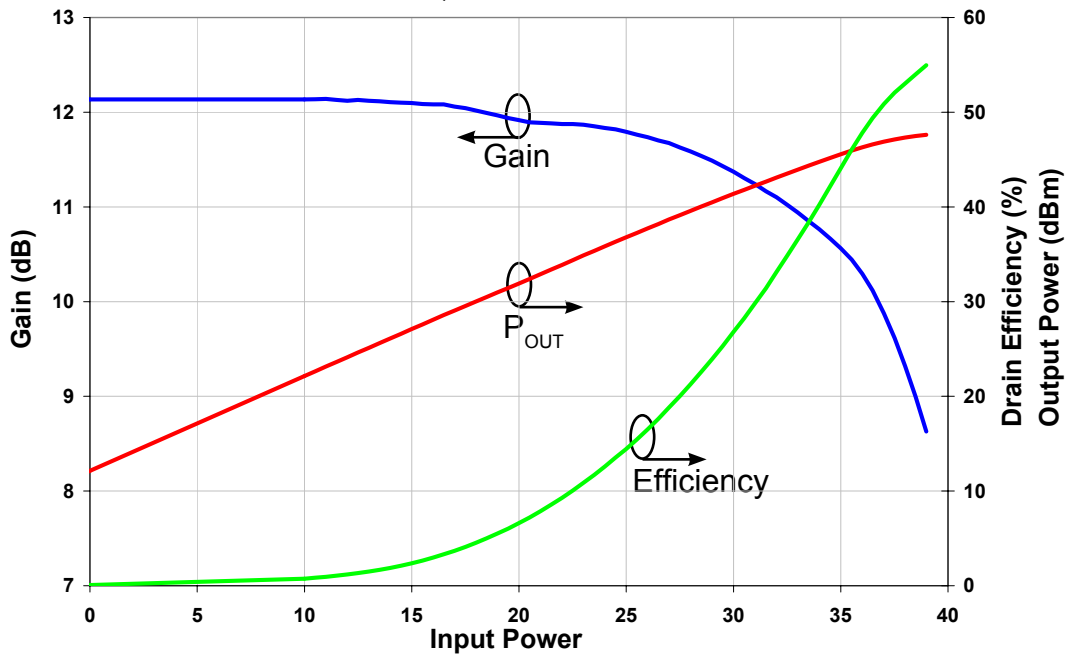

Typical Performance

Simulated Maximum Available Gain and K Factor of the CGH40045
 $V_{DD} = 28\text{ V}, I_{DQ} = 400\text{ mA}$

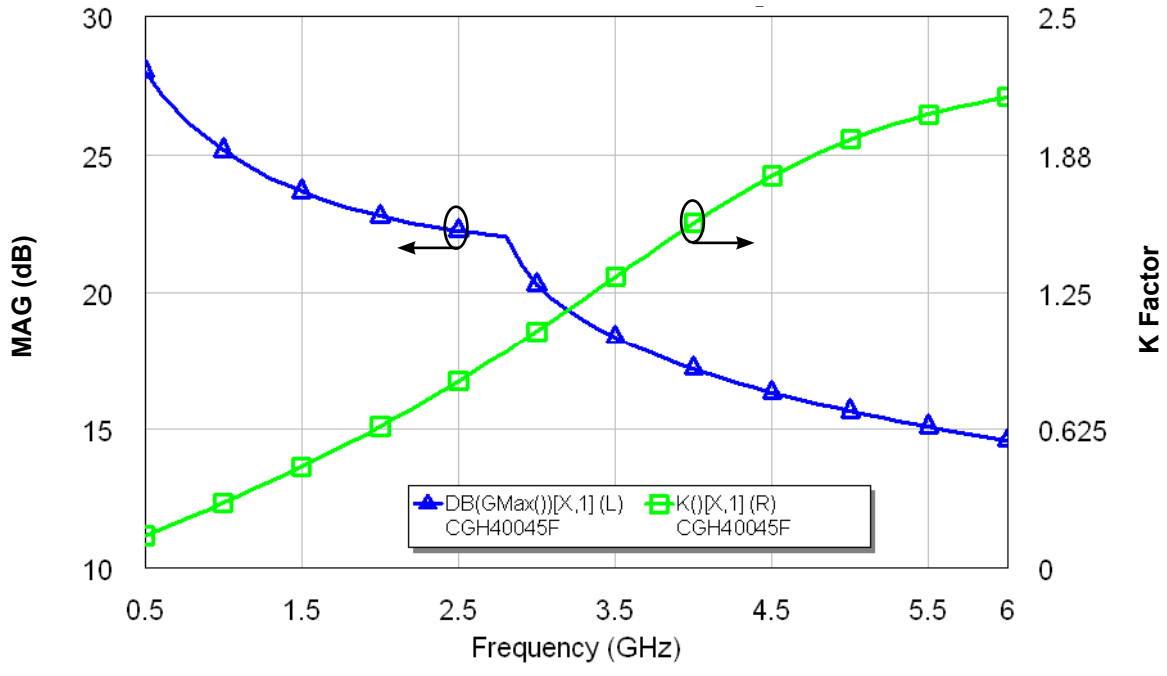

Typical Noise Performance

Simulated Minimum Noise Figure and Noise Resistance vs Frequency of the CGH40045
 $V_{DD} = 28\text{ V}$, $I_{DQ} = 400\text{ mA}$

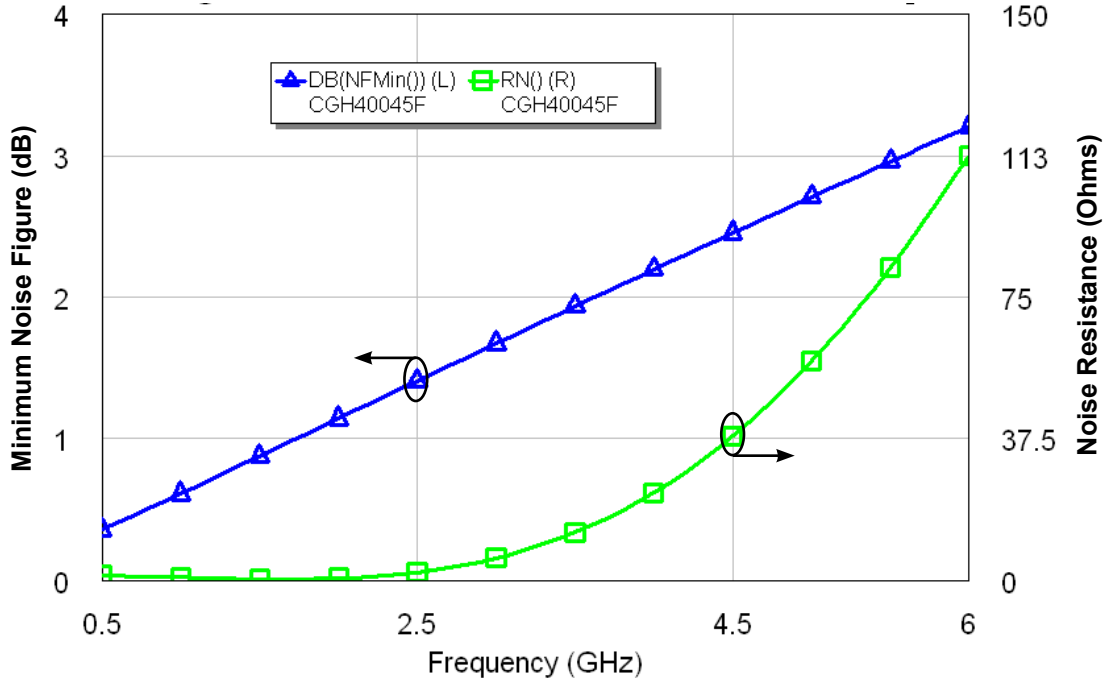

Electrostatic Discharge (ESD) Classifications

Parameter	Symbol	Class	Test Methodology
Human Body Model	HBM	1A > 250 V	JEDEC JESD22 A114-D
Charge Device Model	CDM	1 < 200 V	JEDEC JESD22 C101-C

Simulated Source and Load Impedances

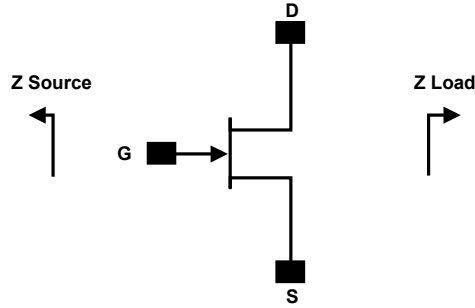

Frequency (MHz)	Z Source	Z Load
500	4.1 + j5.27	14.73 + j6.91
750	2.9 + j 4.1	12.3 + j 7.6
1000	2.48 + j0.06	8.13 + j6.85
1100	1.9 + j 3.1	9.2 + j 6.2
1500	2.1 - j 2.5	6.0 + j 4.3
1700	1.05 - j2.48	5.07 + j2.29
1800	2.1 - j1.9	5.8 + j 4.1
1900	0.89 - j2.62	4.81 + j2.17
2000	0.69 - j3.75	4.93 + j0.16
2100	1.5 - j 4.4	5.1 + j 2.8
3000	1.06 - j8.92	4.04 - j2.98
4000	1.67 - j18.1	4.97 - j8.25

Note 1. $V_{DD} = 28V$, $I_{DQ} = 800mA$ in the 440193 package.

Note 2. Optimized for power gain, P_{SAT} and PAE.

Note 3. When using this device at low frequency, series resistors should be used to maintain amplifier stability.

CGH40045 Power Dissipation De-rating Curve

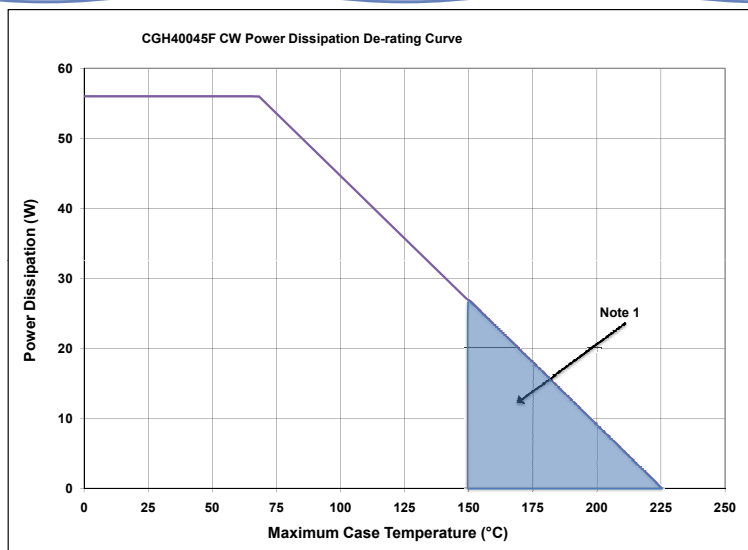

Note 1. Area exceeds Maximum Case Operating Temperature (See Page 2).

CGH40045-AMP Demonstration Amplifier Circuit Schematic

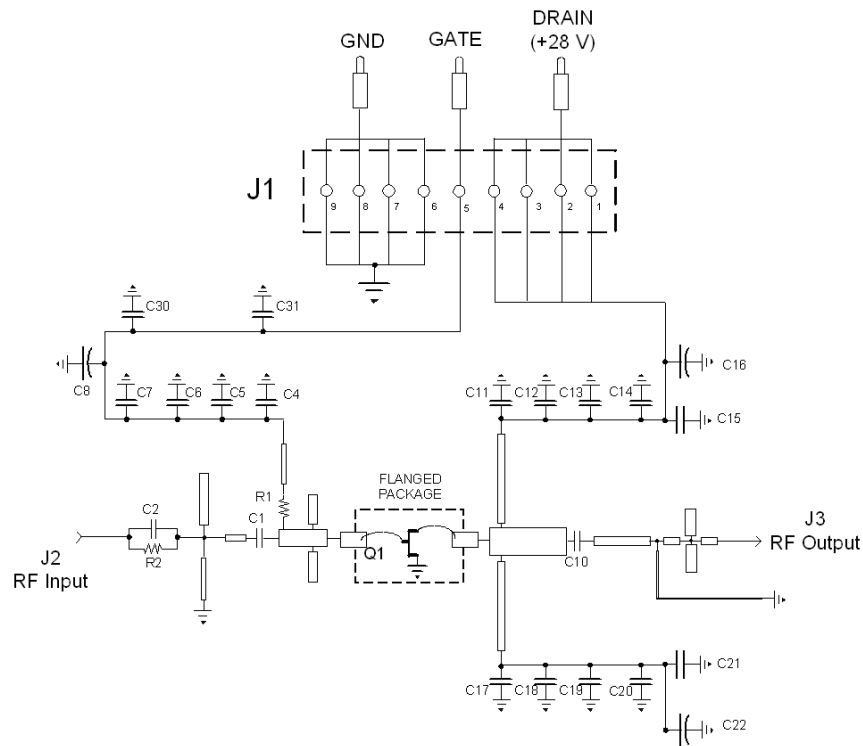

CGH40045-AMP Demonstration Amplifier Circuit Outline

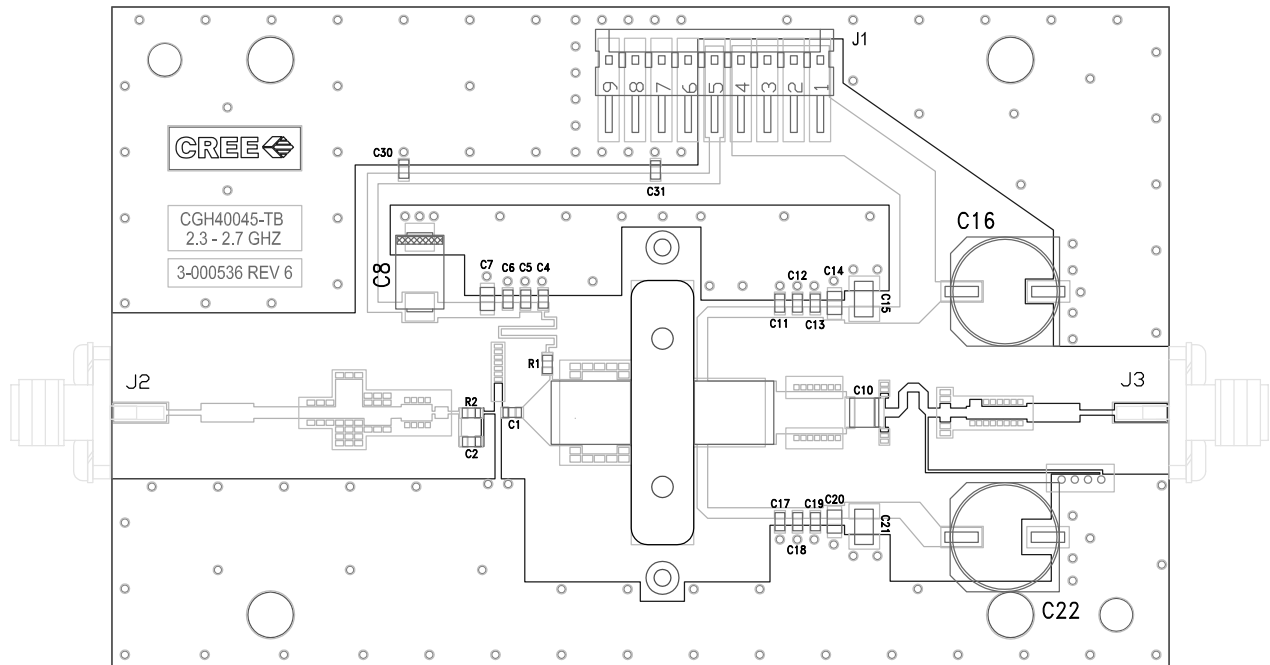

Note: The device slot is machined to different depths to support either pill or flanged versions

CGH40045-AMP Demonstration Amplifier Circuit Bill of Materials

Designator	Description	Qty
C1	CAP, 0.8pF, ± 0.1 pF, 0603	1
C2	CAP, 2.2pF, ± 0.1 pF, 0603	1
C4,C11,C17	CAP, 10.0pF, +/-5%, 0603, ATC	3
C6,C13, C19	CAP, 470pF ±5 %, 100 V, 0603, X7R	3
C7,C14,C20	CAP,33000PF, 0805,100V, X7R	3
C8	CAP, 10UF, 16V, SMT, TANTALUM	1
C10	CAP, 8.2pF ±5%, ATC100B	1
C15,C21	CAP, 1.0UF ±10%, 100V, 1210, X7R	2
C5,C12,C18,C30,C31	CAP, 82.0pF, ±5%, 0603	5
C16,C22	CAP, 33UF, 20%, G CASE	2
R2	RES, 1/16W, 0603, 100 Ohms 1%	1
R1	RES, 1/16W, 0603, 5.1 Ohms 1%	1
J2,J3	CONN, SMA, PANEL MOUNT JACK, FLANGE	2
J1	CONN, HEADER, RT>PLZ .1CEN LK 9POS	1
-	PCB, RO4350B, Er = 3.48, h = 20 mil	1
Q1	CGH40045	1

CGH40045-AMP Demonstration Amplifier Circuit

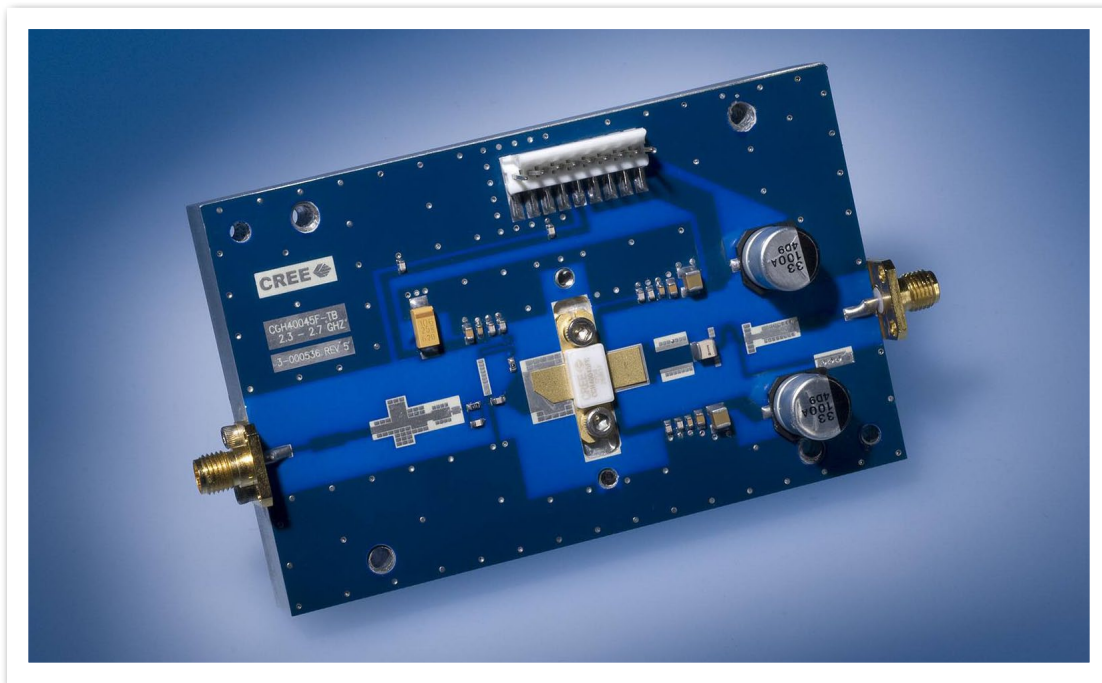

Typical Package S-Parameters for CGH40045
 (Small Signal, $V_{DS} = 28\text{ V}$, $I_{DQ} = 400\text{ mA}$, angle in degrees)

Frequency	Mag S11	Ang S11	Mag S21	Ang S21	Mag S12	Ang S12	Mag S22	Ang S22
500 MHz	0.941	-171.75	7.34	80.91	0.012	-3.58	0.650	-173.39
600 MHz	0.941	-174.07	6.12	77.22	0.012	-6.14	0.655	-173.73
700 MHz	0.941	-175.88	5.24	73.81	0.012	-8.41	0.660	-173.93
800 MHz	0.942	-177.39	4.59	70.58	0.012	-10.49	0.665	-174.05
900 MHz	0.942	-178.70	4.07	67.49	0.012	-12.42	0.671	-174.15
1.0 GHz	0.942	-179.88	3.66	64.51	0.011	-14.23	0.677	-174.24
1.1 GHz	0.943	179.05	3.33	61.61	0.011	-15.93	0.683	-174.35
1.2 GHz	0.943	178.03	3.05	58.78	0.011	-17.54	0.689	-174.49
1.3 GHz	0.944	177.07	2.82	56.03	0.011	-19.06	0.695	-174.66
1.4 GHz	0.944	176.13	2.62	53.33	0.011	-20.50	0.701	-174.86
1.5 GHz	0.945	175.21	2.45	50.69	0.011	-21.86	0.707	-175.10
1.6 GHz	0.945	174.30	2.30	48.10	0.011	-23.14	0.713	-175.37
1.7 GHz	0.945	173.40	2.17	45.56	0.011	-24.34	0.718	-175.68
1.8 GHz	0.946	172.49	2.06	43.05	0.010	-25.47	0.724	-176.02
1.9 GHz	0.946	171.58	1.96	40.59	0.010	-26.53	0.729	-176.40
2.0 GHz	0.946	170.65	1.87	38.16	0.010	-27.51	0.734	-176.81
2.1 GHz	0.946	169.70	1.80	35.76	0.010	-28.43	0.739	-177.25
2.2 GHz	0.946	168.73	1.73	33.39	0.010	-29.28	0.743	-177.72
2.3 GHz	0.946	167.73	1.67	31.03	0.010	-30.06	0.747	-178.21
2.4 GHz	0.945	166.70	1.62	28.70	0.010	-30.78	0.751	-178.74
2.5 GHz	0.945	165.63	1.57	26.37	0.010	-31.44	0.754	-179.28
2.6 GHz	0.945	164.53	1.54	24.06	0.010	-32.05	0.757	-179.85
2.7 GHz	0.944	163.38	1.50	21.74	0.009	-32.60	0.759	179.55
2.8 GHz	0.943	162.17	1.47	19.42	0.009	-33.10	0.761	178.93
2.9 GHz	0.942	160.91	1.45	17.09	0.009	-33.56	0.763	178.28
3.0 GHz	0.941	159.57	1.43	14.74	0.009	-33.99	0.764	177.61
3.2 GHz	0.938	156.68	1.41	9.95	0.009	-34.75	0.766	176.20
3.4 GHz	0.935	153.41	1.41	5.00	0.009	-35.46	0.765	174.68
3.6 GHz	0.930	149.66	1.42	-0.20	0.010	-36.21	0.763	173.05
3.8 GHz	0.923	145.28	1.46	-5.76	0.010	-37.13	0.758	171.27
4.0 GHz	0.914	140.09	1.52	-11.80	0.011	-38.39	0.751	169.35
4.2 GHz	0.903	133.82	1.60	-18.50	0.011	-40.21	0.742	167.23
4.4 GHz	0.888	126.08	1.71	-26.07	0.012	-42.86	0.729	164.90
4.6 GHz	0.868	116.32	1.86	-34.83	0.013	-46.72	0.712	162.27
4.8 GHz	0.842	103.74	2.05	-45.14	0.015	-52.24	0.690	159.29
5.0 GHz	0.811	87.25	2.27	-57.50	0.017	-59.93	0.663	155.80
5.2 GHz	0.777	65.61	2.51	-72.38	0.019	-70.34	0.628	151.60
5.4 GHz	0.752	38.13	2.72	-90.03	0.021	-83.73	0.581	146.39
5.6 GHz	0.753	6.31	2.83	-110.07	0.023	-99.76	0.516	139.81
5.8 GHz	0.785	-25.54	2.78	-131.39	0.023	-117.31	0.427	131.59
6.0 GHz	0.835	-53.19	2.58	-152.64	0.022	-135.03	0.311	121.26

To download the s-parameters in s2p format, go to the [CGH40045 Product Page](#) and click on the documentation tab.

Typical Package S-Parameters for CGH40045
 (Small Signal, $V_{DS} = 28\text{ V}$, $I_{DQ} = 800\text{ mA}$, angle in degrees)

Frequency	Mag S11	Ang S11	Mag S21	Ang S21	Mag S12	Ang S12	Mag S22	Ang S22
500 MHz	0.952	-172.90	7.23	81.83	0.009	-1.13	0.688	-176.19
600 MHz	0.952	-175.11	6.03	78.47	0.009	-3.05	0.691	-176.58
700 MHz	0.952	-176.85	5.18	75.35	0.009	-4.72	0.694	-176.86
800 MHz	0.952	-178.32	4.54	72.38	0.009	-6.21	0.696	-177.07
900 MHz	0.952	-179.59	4.05	69.53	0.009	-7.58	0.699	-177.25
1.0 GHz	0.952	179.25	3.65	66.76	0.009	-8.84	0.702	-177.42
1.1 GHz	0.952	178.19	3.33	64.06	0.009	-10.01	0.706	-177.59
1.2 GHz	0.952	177.18	3.06	61.42	0.009	-11.09	0.709	-177.77
1.3 GHz	0.952	176.22	2.83	58.82	0.009	-12.11	0.712	-177.96
1.4 GHz	0.952	175.28	2.64	56.27	0.009	-13.05	0.716	-178.17
1.5 GHz	0.952	174.37	2.48	53.75	0.009	-13.92	0.719	-178.41
1.6 GHz	0.952	173.46	2.34	51.27	0.009	-14.72	0.722	-178.67
1.7 GHz	0.952	172.55	2.21	48.82	0.009	-15.46	0.725	-178.95
1.8 GHz	0.952	171.64	2.11	46.39	0.009	-16.14	0.728	-179.26
1.9 GHz	0.952	170.72	2.01	43.99	0.009	-16.75	0.731	-179.59
2.0 GHz	0.951	169.78	1.93	41.60	0.009	-17.29	0.734	-179.94
2.1 GHz	0.951	168.83	1.86	39.23	0.009	-17.78	0.737	179.67
2.2 GHz	0.951	167.85	1.80	36.88	0.008	-18.21	0.739	179.27
2.3 GHz	0.950	166.84	1.74	34.53	0.008	-18.58	0.741	178.83
2.4 GHz	0.949	165.80	1.69	32.19	0.008	-18.90	0.743	178.38
2.5 GHz	0.949	164.73	1.65	29.85	0.008	-19.17	0.744	177.90
2.6 GHz	0.948	163.61	1.61	27.51	0.008	-19.40	0.746	177.39
2.7 GHz	0.947	162.44	1.58	25.15	0.008	-19.59	0.747	176.86
2.8 GHz	0.946	161.22	1.56	22.79	0.008	-19.74	0.747	176.31
2.9 GHz	0.945	159.94	1.54	20.40	0.009	-19.87	0.748	175.73
3.0 GHz	0.943	158.58	1.53	17.98	0.009	-19.99	0.747	175.12
3.2 GHz	0.940	155.64	1.51	13.04	0.009	-20.21	0.746	173.83
3.4 GHz	0.935	152.30	1.51	7.90	0.009	-20.51	0.743	172.44
3.6 GHz	0.930	148.47	1.54	2.47	0.010	-21.01	0.738	170.92
3.8 GHz	0.922	143.99	1.58	-3.34	0.010	-21.86	0.730	169.27
4.0 GHz	0.913	138.66	1.65	-9.68	0.011	-23.25	0.721	167.47
4.2 GHz	0.900	132.21	1.75	-16.72	0.012	-25.41	0.708	165.49
4.4 GHz	0.884	124.23	1.87	-24.68	0.013	-28.63	0.691	163.32
4.6 GHz	0.863	114.16	2.04	-33.86	0.015	-33.25	0.671	160.90
4.8 GHz	0.835	101.18	2.24	-44.66	0.017	-39.70	0.646	158.17
5.0 GHz	0.802	84.20	2.47	-57.54	0.020	-48.45	0.616	155.00
5.2 GHz	0.768	62.03	2.72	-72.91	0.022	-59.96	0.577	151.18
5.4 GHz	0.745	34.19	2.91	-90.96	0.025	-74.38	0.527	146.39
5.6 GHz	0.750	2.50	2.99	-111.20	0.026	-91.25	0.459	140.32
5.8 GHz	0.785	-28.66	2.91	-132.50	0.027	-109.41	0.366	132.93
6.0 GHz	0.837	-55.46	2.67	-153.57	0.025	-127.56	0.245	124.60

To download the s-parameters in s2p format, go to the [CGH40045 Product Page](#) and click on the documentation tab.

Product Dimensions CGH40045F (Package Type – 440193)

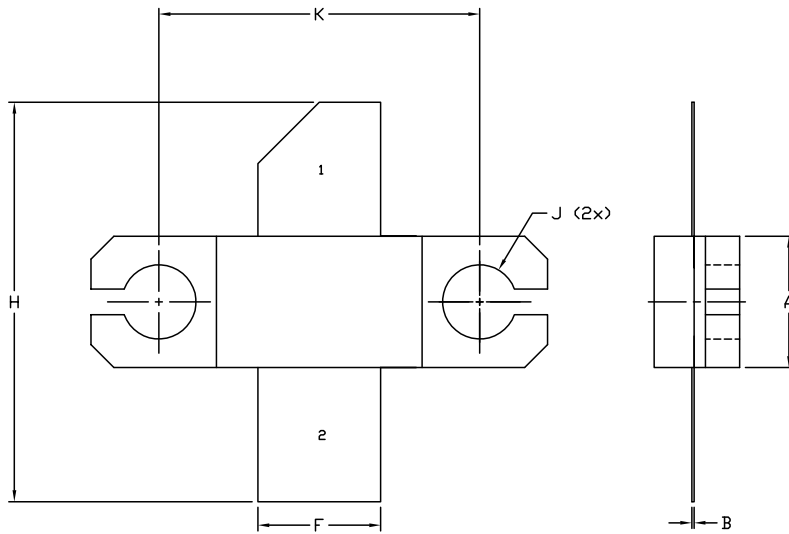

- NOTES:
1. DIMENSIONING AND TOLERANCING PER ANSI Y14.5M, 1982.
 2. CONTROLLING DIMENSION: INCH.
 3. ADHESIVE FROM LID MAY EXTEND A MAXIMUM OF 0.020" BEYOND EDGE OF LID.
 4. LID MAY BE MISALIGNED TO THE BODY OF THE PACKAGE BY A MAXIMUM OF 0.008" IN ANY DIRECTION.
 5. ALL PLATED SURFACES ARE Ni/AU.

DIM	INCHES		MILLIMETERS	
	MIN	MAX	MIN	MAX
A	0.225	0.235	5.72	5.97
B	0.004	0.006	0.10	0.15
C	0.145	0.165	3.68	4.19
D	0.077	0.087	1.96	2.21
E	0.355	0.365	9.02	9.27
F	0.210	0.220	5.33	5.59
G	0.795	0.805	20.19	20.45
H	0.670	0.730	17.02	18.54
J	∅ .130		3.30	
k		0.562		14.28

- PIN 1. GATE
 PIN 2. DRAIN
 PIN 3. SOURCE

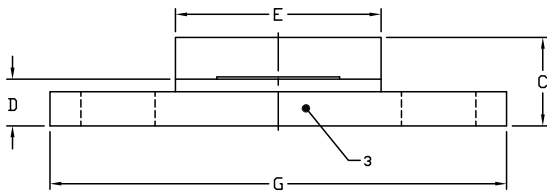

Product Dimensions CGH40045P (Package Type – 440206)

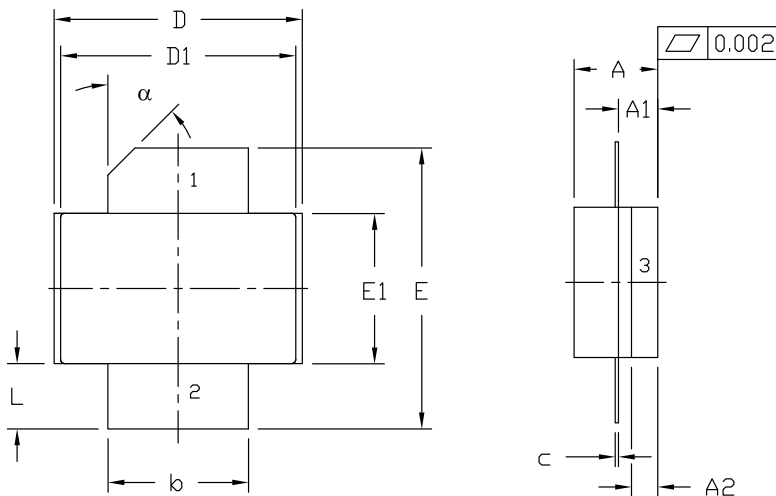



- NOTES:
1. DIMENSIONING AND TOLERANCING PER ANSI Y14.5M – 1994.
 2. CONTROLLING DIMENSION: INCH.
 3. ADHESIVE FROM LID MAY EXTEND A MAXIMUM OF 0.020" BEYOND EDGE OF LID.
 4. LID MAY BE MISALIGNED TO THE BODY OF PACKAGE BY A MAXIMUM OF 0.008" IN ANY DIRECTION.

DIM	INCHES		MILLIMETERS		NOTES
	MIN	MAX	MIN	MAX	
A	0.125	0.145	3.18	3.68	
A1	0.057	0.067	1.45	1.70	
A2	0.035	0.045	0.89	1.14	
b	0.210	0.220	5.33	5.59	2x
c	0.004	0.006	0.10	0.15	2x
D	0.375	0.385	9.53	9.78	
D1	0.355	0.365	9.02	9.27	
E	0.400	0.460	10.16	11.68	
E1	0.225	0.235	5.72	5.97	
L	0.085	0.115	2.16	2.92	2x
α		45° REF		45° REF	

- PIN 1. GATE
 PIN 2. DRAIN
 PIN 3. SOURCE

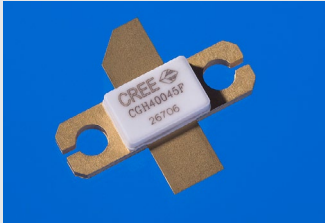
Product Ordering Information

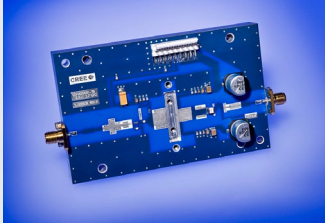
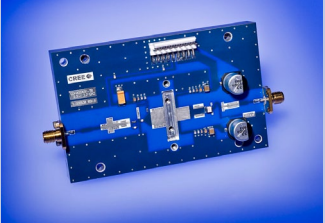
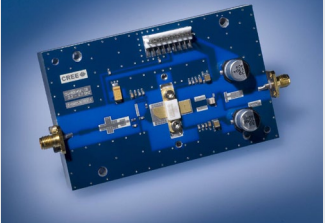
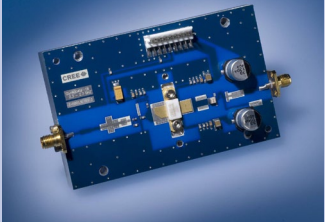
Order Number	Description	Unit of Measure	Image
CGH40045F	GaN HEMT	Each	
CGH40045P	GaN HEMT	Each	
CGH40045F-TB	Test board without GaN HEMT	Each	
CGH40045P-TB	Test board without GaN HEMT	Each	
CGH40045F-AMP	Test board with GaN HEMT installed	Each	
CGH40045P-AMP	Test board with GaN HEMT installed	Each	



Disclaimer

Specifications are subject to change without notice. Cree, Inc. believes the information contained within this data sheet to be accurate and reliable. However, no responsibility is assumed by Cree for any infringement of patents or other rights of third parties which may result from its use. No license is granted by implication or otherwise under any patent or patent rights of Cree. Cree makes no warranty, representation or guarantee regarding the suitability of its products for any particular purpose. "Typical" parameters are the average values expected by Cree in large quantities and are provided for information purposes only. These values can and do vary in different applications and actual performance can vary over time. All operating parameters should be validated by customer's technical experts for each application. Cree products are not designed, intended or authorized for use as components in applications intended for surgical implant into the body or to support or sustain life, in applications in which the failure of the Cree product could result in personal injury or death or in applications for planning, construction, maintenance or direct operation of a nuclear facility.

For more information, please contact:

Cree, Inc.
4600 Silicon Drive
Durham, North Carolina, USA 27703
www.cree.com/RF

Sarah Miller
Marketing & Export
Cree, RF Components
1.919.407.5302

Ryan Baker
Marketing
Cree, RF Components
1.919.407.7816

Tom Dekker
Sales Director
Cree, RF Components
1.919.407.5639