



Chipsmall Limited consists of a professional team with an average of over 10 year of expertise in the distribution of electronic components. Based in Hongkong, we have already established firm and mutual-benefit business relationships with customers from,Europe,America and south Asia,supplying obsolete and hard-to-find components to meet their specific needs.

With the principle of “Quality Parts,Customers Priority,Honest Operation,and Considerate Service”,our business mainly focus on the distribution of electronic components. Line cards we deal with include Microchip,ALPS,ROHM,Xilinx,Pulse,ON,Everlight and Freescale. Main products comprise IC,Modules,Potentiometer,IC Socket,Relay,Connector.Our parts cover such applications as commercial,industrial, and automotives areas.

We are looking forward to setting up business relationship with you and hope to provide you with the best service and solution. Let us make a better world for our industry!



Contact us

Tel: +86-755-8981 8866 Fax: +86-755-8427 6832

Email & Skype: info@chipsmall.com Web: www.chipsmall.com

Address: A1208, Overseas Decoration Building, #122 Zhenhua RD., Futian, Shenzhen, China



CGHV40180F

180 W, DC - 2000 MHz, 50 V, GaN HEMT

Cree's CGHV40180F is an unmatched, gallium nitride (GaN) high electron mobility transistor (HEMT). The CGHV40180F, operating from a 50 volt rail, offers a general purpose, broadband solution to a variety of RF and microwave applications. GaN HEMTs offer high efficiency, high gain and wide bandwidth capabilities making the CGHV40180F ideal for linear and compressed amplifier circuits. The transistor is available in a 2-lead flange package.



Package Types: 440223
PN: CGHV40180F

Typical Performance Over 800 MHz - 1000 MHz ($T_c = 25^\circ\text{C}$), 50 V

Parameter	800 MHz	850 MHz	900 MHz	950 MHz	1000 MHz	Units
Small Signal Gain	25.6	25.2	24.9	24.4	24.3	dB
Gain @ Pin 34 dBm	20.4	20.8	20.3	20.1	20.1	dB
Output Power @ Pin 34 dBm	275	302	279	257	257	W
EFF @ Pin 34 dBm	67	75	73	73	71	%

Note:
Measured CW in the CGHV40180F-AMP Application circuit.



FEATURES

- Up to 2000 MHz Operation
- 24 dB Small Signal Gain at 900 MHz
- 20 dB Power Gain at 900 MHz
- 250 W Typical Output Power at 900 MHz
- 75 % Efficiency at P_{SAT}

APPLICATIONS

- Military Communications
- Public Safety VHF-UHF applications
- Radar
- Medical
- Broadband Amplifiers

Large Signal Models Available for ADS and MWO

Absolute Maximum Ratings (not simultaneous) at 25°C Case Temperature

Parameter	Symbol	Rating	Units	Conditions
Drain-Source Voltage	V_{DS}	125	Volts	25°C
Gate-to-Source Voltage	V_{GS}	-10, +2	Volts	25°C
Storage Temperature	T_{STG}	-65, +150	°C	
Operating Junction Temperature ¹	T_J	225	°C	
Maximum Forward Gate Current	I_{GMAX}	42	mA	25°C
Maximum Drain Current ¹	I_{DMAX}	12.1	A	25°C
Soldering Temperature ²	T_S	245	°C	
Screw Torque	τ	40	in-oz	
CGHV40180F Thermal Resistance, Junction to Case	R_{JJC}	0.95	°C/W	$P_{DISS} = 150, 85^\circ\text{C}$
Maximum dissipated power		150	W	$P_{DISS} = 150, 85^\circ\text{C}$
Case Operating Temperature ³	T_C	-40, +150	°C	

Note:

¹ Current limit for long term, reliable operation

² Refer to the Application Note on soldering at www.cree.com/RF/Document-Library

³ See also, Power Derating Curve on Page 5.

Electrical Characteristics

Characteristics	Symbol	Min.	Typ.	Max.	Units	Conditions
DC Characteristics¹ ($T_C = 25^\circ\text{C}$)						
Gate Threshold Voltage	$V_{GS(th)}$	-3.8	-3.0	-2.3	V_{DC}	$V_{DS} = 10\text{ V}, I_D = 20.8\text{ mA}$
Gate Quiescent Voltage	$V_{GS(Q)}$	-	-2.7	-	V_{DC}	$V_{DS} = 50\text{ V}, I_D = 1000\text{ mA}$
Saturated Drain Current ²	I_{DS}	31.4	37.6	-	A	$V_{DS} = 6.0\text{ V}, V_{GS} = 2.0\text{ V}$
Drain-Source Breakdown Voltage	V_{BR}	150	-	-	V_{DC}	$V_{GS} = -8\text{ V}, I_D = 41.8\text{ mA}$
RF Characteristics^{2,3} ($T_C = 25^\circ\text{C}, F_0 = 900\text{ MHz}$ unless otherwise noted)						
Small Signal Gain	G_{SS}	23.4	24.0	-	dB	$V_{DD} = 50\text{ V}, I_{DQ} = 1.0\text{ A}, P_{in} = 10\text{ dBm CW}$
Power Gain	G_P	19.3	20.3	-	dB	$V_{DD} = 50\text{ V}, I_{DQ} = 1.0\text{ A}, P_{in} = 34\text{ dBm CW}$
Power Output at Saturation	P_{OUT}	53.7	54.3	-	dBm	$V_{DD} = 50\text{ V}, I_{DQ} = 1.0\text{ A}, P_{in} = 34\text{ dBm CW}$
Drain Efficiency ⁴	η	64	74	-	%	$V_{DD} = 50\text{ V}, I_{DQ} = 1.0\text{ A}, P_{in} = 34\text{ dBm CW}$
Output Mismatch Stress	VSWR	-	-	3 : 1	Ψ	No damage at all phase angles, $V_{DD} = 50\text{ V}, I_{DQ} = 1.0\text{ A}, P_{OUT} = 180\text{ W CW}$
Dynamic Characteristics						
Input Capacitance	C_{GS}	-	57.8	-	pF	$V_{DS} = 50\text{ V}, V_{GS} = -8\text{ V}, f = 1\text{ MHz}$
Output Capacitance	C_{DS}	-	13.7	-	pF	$V_{DS} = 50\text{ V}, V_{GS} = -8\text{ V}, f = 1\text{ MHz}$
Feedback Capacitance	C_{GD}	-	1.23	-	pF	$V_{DS} = 50\text{ V}, V_{GS} = -8\text{ V}, f = 1\text{ MHz}$

Notes:

¹ Measured on wafer prior to packaging.

² Scaled from PCM data.

³ Measurements are to be performed using Cree production test fixture AD-838292F-TB

⁴ Drain Efficiency = P_{OUT}/PDC

CGHV40180F Typical Performance

Figure 1. - Small Signal Gain and Return Loss versus Frequency
 measured in application circuit CGHV40180F
 $V_{DD} = 50\text{ V}$, $I_{DQ} = 1.0\text{ A}$

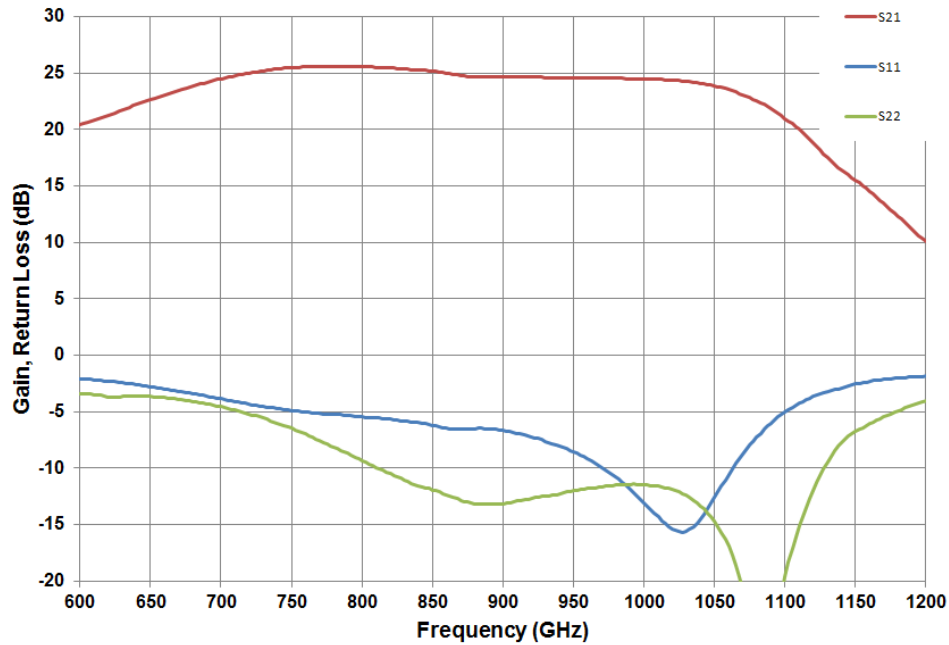
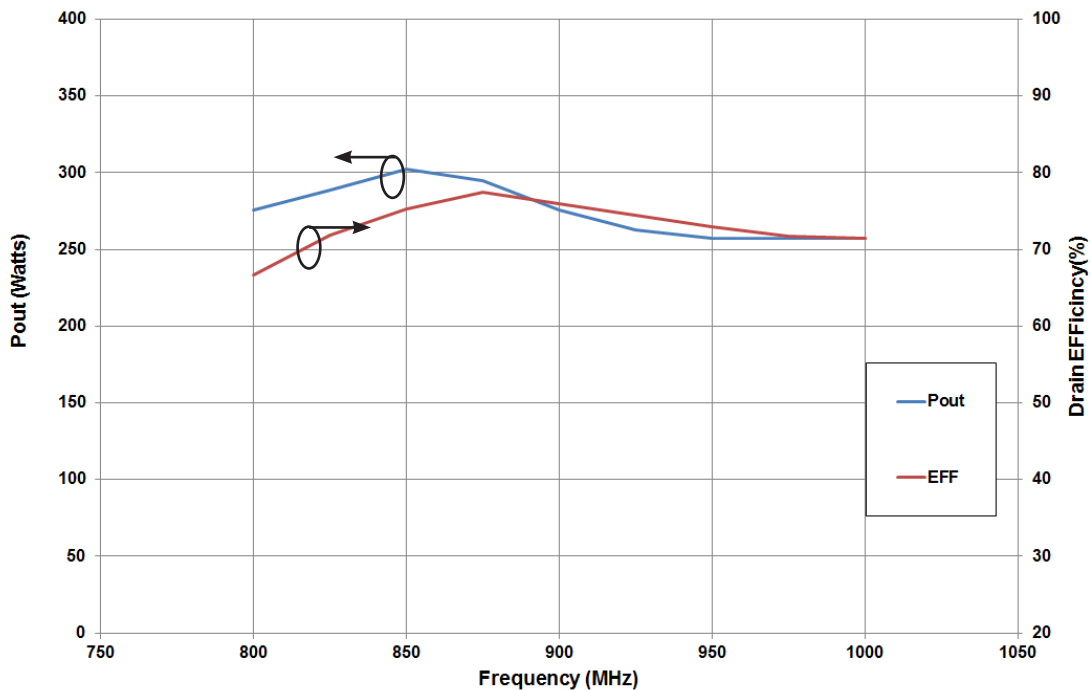

Figure 2. - Output Power and Drain Efficiency vs Frequency
 CGHV40180F-TB
 CW Operation, $V_{DD} = 50\text{ V}$, $I_{DQ} = 1.0\text{ A}$, @ $P_{IN} 34\text{ dBm}$



CGHV40180F Typical Performance

Figure 3. - Gain and Drain EFF vs. Frequency and Output Power
CGHV40180F-TB
CW Operation, $V_{DD} = 50\text{ V}$, $I_{DQ} = 1.0\text{ A}$

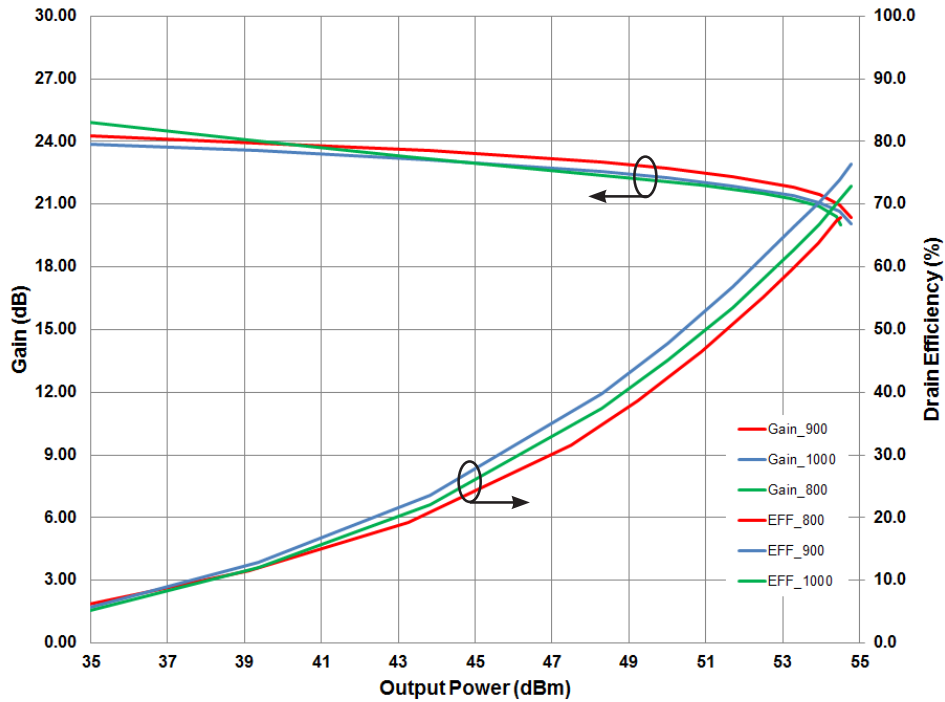
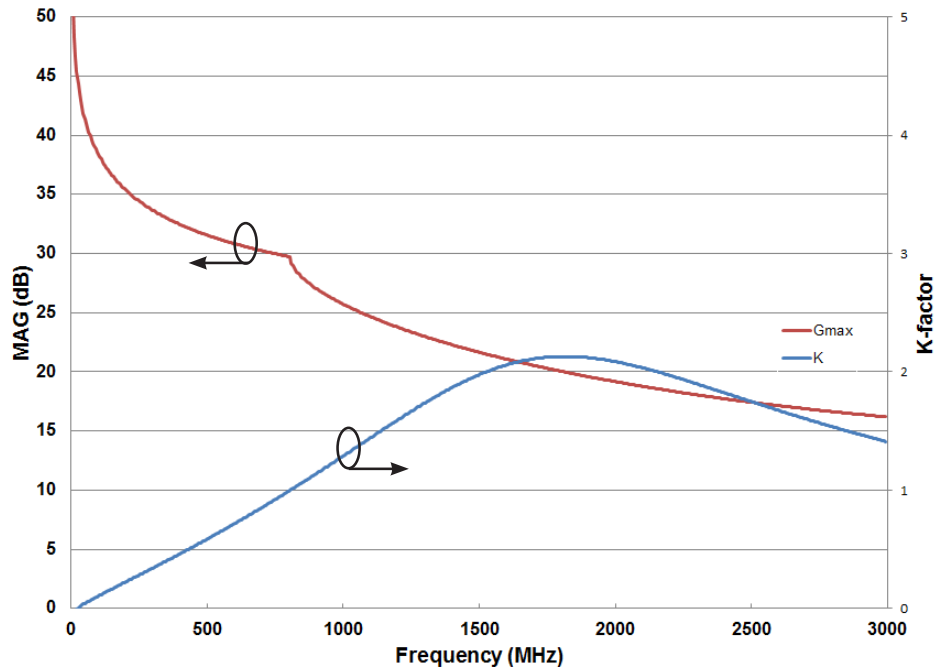
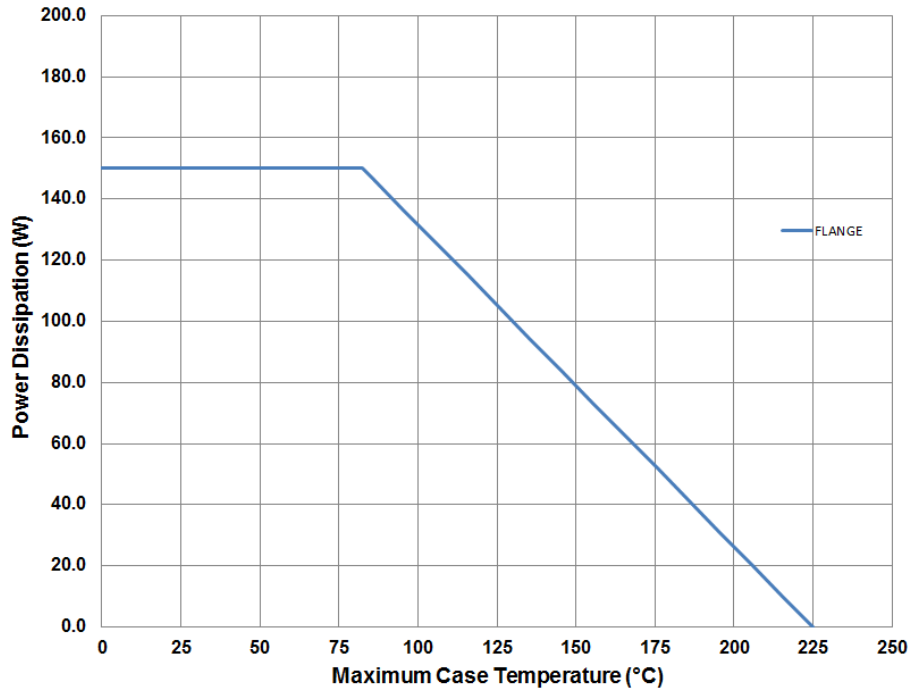

Figure 4. - Simulated Maximum Available Gain and K-factor of the CGHV40180F
 $V_{DD} = 50\text{ V}$, $I_{DQ} = 1.0\text{ A}$



CGHV40180F Power Dissipation De-rating Curve

Figure 5. - Transient Power Dissipation De-rating Curve



CGHV40180F-AMP Application Circuit Schematic

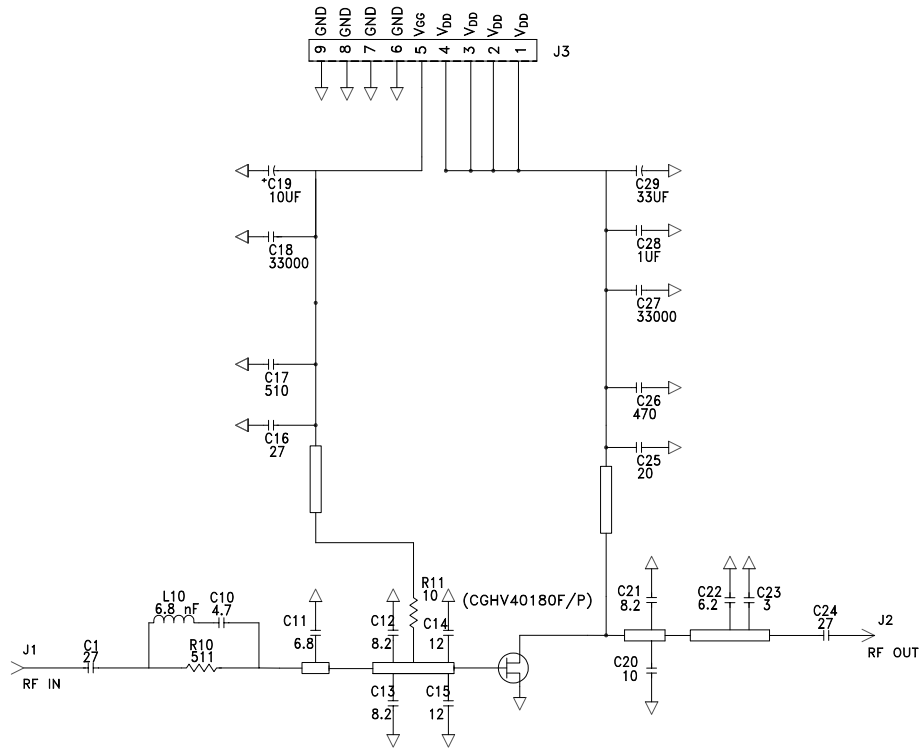

CGHV40180F-AMP Application Circuit

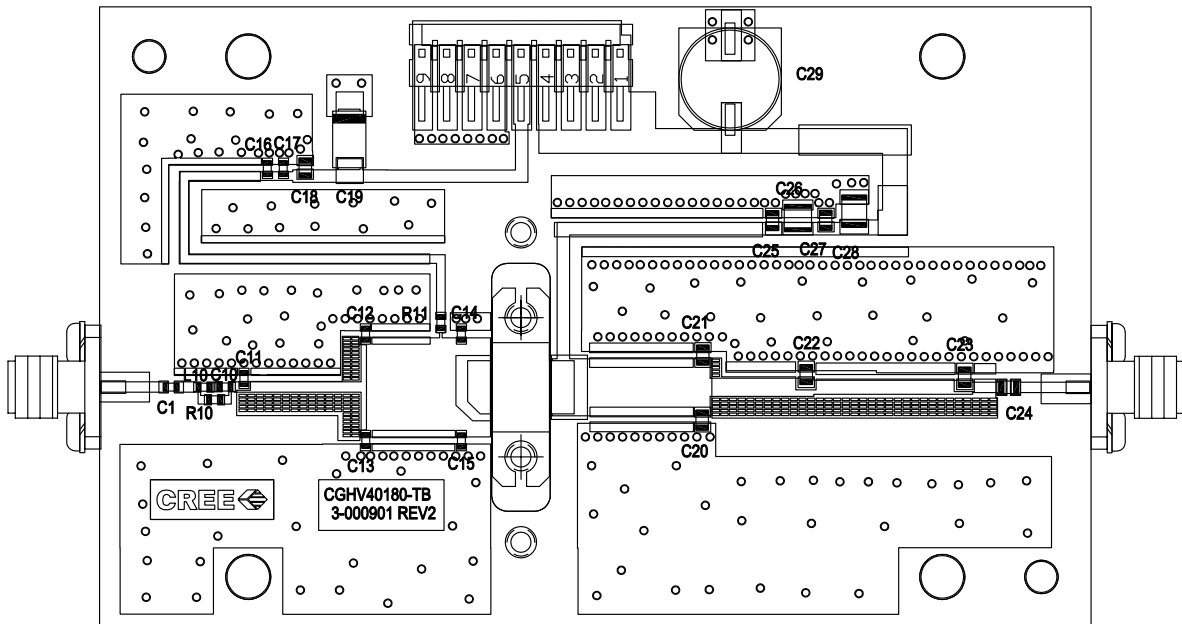

CGHV40180F-AMP Application Circuit Bill of Materials

Designator	Description	Qty
R11	RES, 1/16W, 0603, 1%, 10.0 OHMS	1
R10	RES, 1/16W, 0603, 1%, 511 OHMS	1
C29	CAP, 33UF, 20%, G CASE	1
C28	CAP 1.0UF, 100V, ±10%, X7R, 1210	1
C17	CAP, 510pF, NPO, 5%, 100V, 0603	1
C26	CAP, 470pF, NPO, 5%, 250V, ATC800B	1
C19	CAP, 10UF, 16V TANTALUM, 2312	1
C14, C15	CAP, 12.0pF, ±5%, 0603, ATC600S	2
C1, C16	CAP, 27pF, ±5%, 0603, ATC600S	2
C10	CAP, 4.7pF, ±0.1pF, 0603, ATC600S	1
C11	CAP, 6.8pF, ±0.25pF, 0603, ATC600S	1
C12, C13	CAP, 8.2pF, ±0.25 pF, 0603, ATC600S	2
C18, C27	CAP, 33000pF, 0805, 100V, X7R	2
C20	CAP, 10pF, ±1%, 250V, 0805, ATC600F	2
C25	CAP, 20pF, ±5%, 250V, 0805, ATC600F	1
C24	CAP, 27pF, ±5%, 250V, 0805, ATC600F	1
C23	CAP, 3.0pF, ±0.1pF, 250V, 0805, ATC600F	2
C22	CAP, 6.2pF, ±0.1pF, 250V, 0805, ATC600F	1
C21	CAP, 8.2pF, ±0.1pF, 250V, 0805 ATC600F	1
-	PCB ROGERS HTC6035, 0.020 THK, ER 3.60	1
J1, J2	CONN, SMA, PANEL MOUNT JACK, FLANGE, 4 HOLE BLUNT POST	2
J3	HEADER RT>PLZ .1CEN LK 9POS	1
L10	INDUCTOR, CHIP, 6.8nH, 5%, 0603 SMT, DIGIKEY 712-1432-1-ND	1
Q1	CGHV40180	1

CGHV40180F-AMP Demonstration Amplifier Circuit

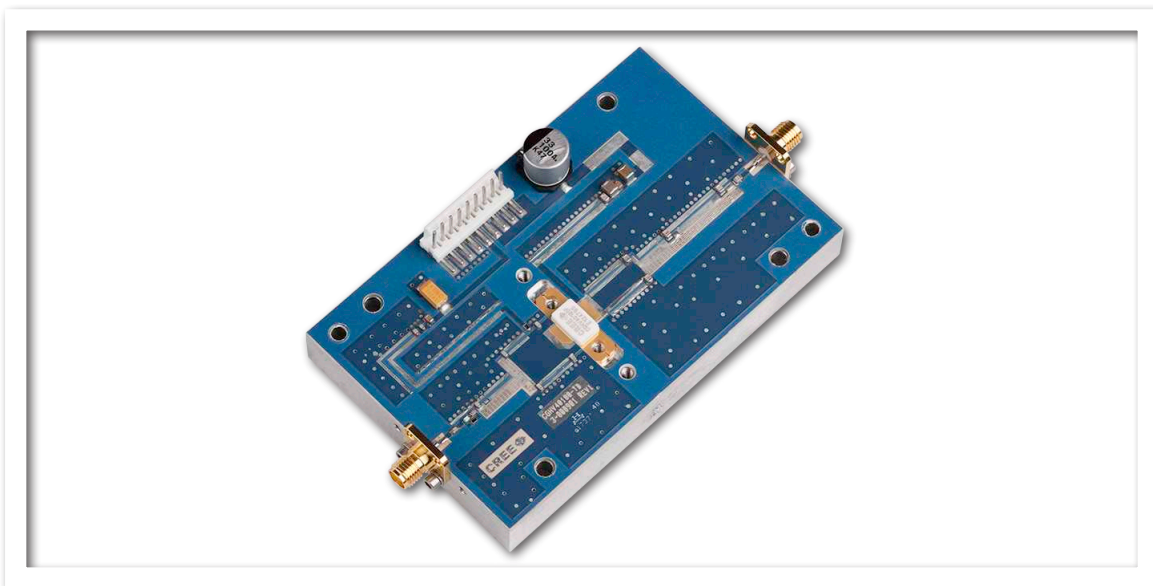

Source and Load Impedances

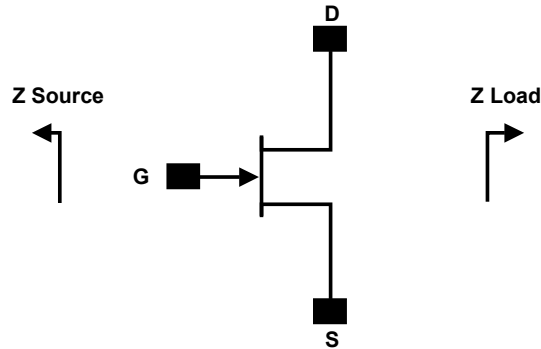

Frequency (MHz)	Z Source	Z Load
50	23.7 + J25.9	7.6 + J0.6
150	7.4 + J8.3	8.1 + J0.7
250	4.2 + J7.9	7.9 + J2.2
500	1.4 + J1.5	4.7 + J2.7
750	1.0 + J0.0	3.9 + J2.3
1000	0.7 + J1.1	4.0 + J1.8

Note 1. $V_{DD} = 50\text{ V}$, $I_{DQ} = 1.0\text{ A}$ in the 440223 package.

Note 2. Optimized for Power Gain, P_{SAT} and Drain Efficiency

Note 3. When using this device at low frequency, series resistor should be used to maintain amplifier stability

Electrostatic Discharge (ESD) Classifications

Parameter	Symbol	Class	Test Methodology
Human Body Model	HBM	1A (> 250 V)	JEDEC JESD22 A114-D
Charge Device Model	CDM	2 (125 V to 250 V)	JEDEC JESD22 C101-C

Product Dimensions CGHV40180F (Package Type – 440223)

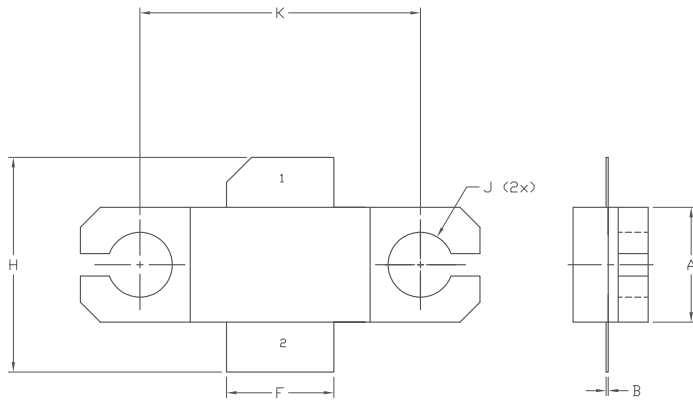

NOTES:

1. DIMENSIONING AND TOLERANCING PER ANSI Y14.5M, 1982.
2. CONTROLLING DIMENSION: INCH.
3. ADHESIVE FROM LID MAY EXTEND A MAXIMUM OF 0.020" BEYOND EDGE OF LID.
4. LID MAY BE MISALIGNED TO THE BODY OF THE PACKAGE BY A MAXIMUM OF 0.008" IN ANY DIRECTION.
5. ALL PLATED SURFACES ARE Ni/AU.

DIM	INCHES		MILLIMETERS	
	MIN	MAX	MIN	MAX
A	0.225	0.235	5.72	5.97
B	0.004	0.006	0.10	0.15
C	0.145	0.165	3.68	4.19
D	0.077	0.087	1.96	2.21
E	0.355	0.365	9.02	9.27
F	0.210	0.220	5.33	5.59
G	0.795	0.805	20.19	20.45
H	0.400	0.460	10.16	11.68
J	∅ .130		3.30	
k	0.562		14.27	

PIN 1. GATE
 PIN 2. DRAIN
 PIN 3. SOURCE

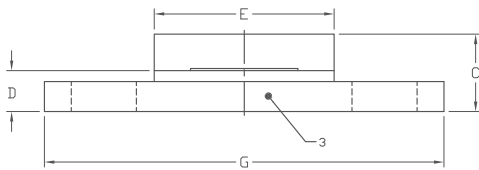

Part Number System

CGHV40180F

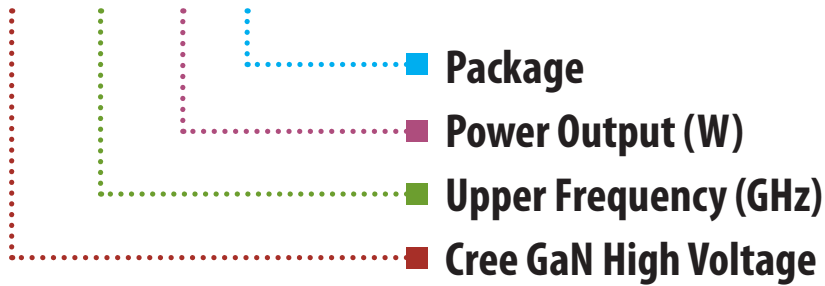

Parameter	Value	Units
Upper Frequency ¹	4.0	GHz
Power Output	100	W
Package	Flange	-

Table 1.

Note¹: Alpha characters used in frequency code indicate a value greater than 9.9 GHz. See Table 2 for value.

Character Code	Code Value
A	0
B	1
C	2
D	3
E	4
F	5
G	6
H	7
J	8
K	9
Examples:	1A = 10.0 GHz 2H = 27.0 GHz

Table 2.

Product Ordering Information

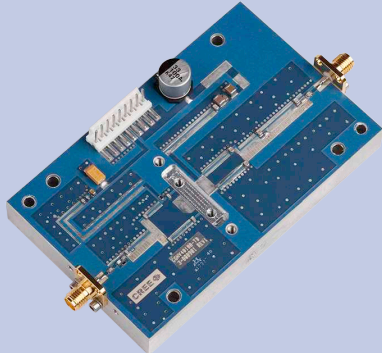
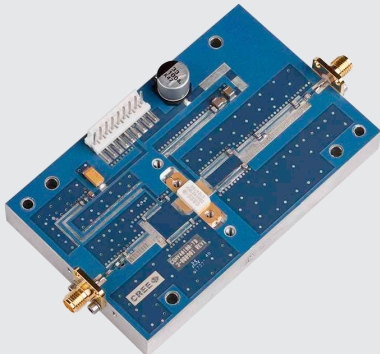
Order Number	Description	Unit of Measure	Image
CGHV40180F	GaN HEMT	Each	
CGHV40180F-TB	Test board without GaN HEMT	Each	
CGHV40180F-AMP	Test board with GaN HEMT (flanged) installed	Each	



Disclaimer

Specifications are subject to change without notice. Cree, Inc. believes the information contained within this data sheet to be accurate and reliable. However, no responsibility is assumed by Cree for any infringement of patents or other rights of third parties which may result from its use. No license is granted by implication or otherwise under any patent or patent rights of Cree. Cree makes no warranty, representation or guarantee regarding the suitability of its products for any particular purpose. "Typical" parameters are the average values expected by Cree in large quantities and are provided for information purposes only. These values can and do vary in different applications and actual performance can vary over time. All operating parameters should be validated by customer's technical experts for each application. Cree products are not designed, intended or authorized for use as components in applications intended for surgical implant into the body or to support or sustain life, in applications in which the failure of the Cree product could result in personal injury or death or in applications for planning, construction, maintenance or direct operation of a nuclear facility.

For more information, please contact:

Cree, Inc.
4600 Silicon Drive
Durham, North Carolina, USA 27703
www.cree.com/RF

Sarah Miller
Marketing
Cree, RF Components
1.919.407.5302

Ryan Baker
Marketing & Sales
Cree, RF Components
1.919.407.7816

Tom Dekker
Sales Director
Cree, RF Components
1.919.407.5639