



Chipsmall Limited consists of a professional team with an average of over 10 year of expertise in the distribution of electronic components. Based in Hongkong, we have already established firm and mutual-benefit business relationships with customers from,Europe,America and south Asia,supplying obsolete and hard-to-find components to meet their specific needs.

With the principle of “Quality Parts,Customers Priority,Honest Operation,and Considerate Service”,our business mainly focus on the distribution of electronic components. Line cards we deal with include Microchip,ALPS,ROHM,Xilinx,Pulse,ON,Everlight and Freescale. Main products comprise IC,Modules,Potentiometer,IC Socket,Relay,Connector.Our parts cover such applications as commercial,industrial, and automotives areas.

We are looking forward to setting up business relationship with you and hope to provide you with the best service and solution. Let us make a better world for our industry!



Contact us

Tel: +86-755-8981 8866 Fax: +86-755-8427 6832

Email & Skype: info@chipsmall.com Web: www.chipsmall.com

Address: A1208, Overseas Decoration Building, #122 Zhenhua RD., Futian, Shenzhen, China



CJ-series Interrupt Input Units

CJ1W-INT01

CSM_CJ1W-INT01_DS_E_2_1

High-speed Starting of I/O Interrupt Tasks. Use Up to Two Units for a Total of Up to 32 Interrupt Inputs.

- Receive inputs to start I/O interrupt tasks. When the Interrupt Input Unit receives an input, the CPU Unit will interrupt execution of the cyclic tasks in the normal program and execute an I/O interrupt task.



CJ1W-INT01

Features

- High-speed ON response of 0.05 ms
 - Use up to 32 interrupt inputs with up to two Units per CPU Unit.
 - Applicable with both NPN and PNP output devices. Polarity selection is not required. *
- * The same polarity is used for the same common.

Ordering Information

International Standards

- The standards are abbreviated as follows: U: UL, U1: UL (Class I Division 2 Products for Hazardous Locations), C: CSA, UC: cULus, UC1: cULus (Class I Division 2 Products for Hazardous Locations), CU: cUL, N: NK, L: Lloyd, and CE: EC Directives.
- Contact your OMRON representative for further details and applicable conditions for these standards.

Interrupt Input Units

Unit type	Product name	Specifications						No. of words allocated	Current consumption (A)		Model	Standards
		I/O points	Input voltage current	Commons	Input pulse width conditions	Max. Units mountable per Unit	External connection		5 V	24 V		
CJ1 Basic I/O Units	Interrupt Input Unit 	16 inputs	24 VDC, 7 mA	16 points, 1 common	ON time: 0.05 ms max. OFF time: 0.5 ms max.	2	Removable terminal block	1 word	0.08	–	CJ1W-INT01	UC1, N, L, CE

Note: 1. Can be used only on CPU Racks, and not on Expansion Racks.

2. The locations where the Units can be mounted depend on the CPU Rack and the CPU Unit model.

CJ2H-CPU6□-EIP: From the slot next to the CPU Unit until the fourth slot.

CJ1G, CJ1H: From the slot next to the CPU Unit until the fifth slot.

CJ1M: From the slot next to the CPU Unit until the third slot.

3. With the SYSMAC NJ-series Controllers, Interrupt Input Units can be used as normal Basic Input Units. They cannot be used to start I/O interrupt tasks.

Accessories

There is no accessory for the CJ series Interrupt Input Units.

Mountable Racks

Model	NJ system		CJ system (CJ1, CJ2)			CP1H system	NSJ system	
	CPU Rack	Expansion Rack	CJ1-CPU Rack	CPU Units other than left	Expansion Backplane	CP1H PLC	NSJ Controller	Expansion Backplane
CJ1W-INT01	2 Units *1*4	Not supported *3	Not supported	2 Units *2	Not supported *3	Not supported	Not supported	Not supported *3

*1. The Interrupt Input Unit can be mounted in slots 0 to 4 on the CJ1-CPU Rack. An Incorrect Unit/Expansion Rack Connection error will occur if an Interrupt Input Unit is mounted to slot 5 or higher.

*2. Connectable slot position changes with the CPU Unit.

- CJ1M-CPU□□: Slot No.0 to 2

- CJ2H-CPU□□-EIP: Slot No.0 to 3

- CPU Unit other than above: Slot No.0 to 4

If the Unit is mounted to the slot other than above, I/O setting error will occur.

*3. An I/O setting error will occur if an Interrupt Input Unit is mounted to an Expansion Rack.

*4. Interrupt Input Units can be used as normal Basic Input Units. They cannot be used to start I/O interrupt tasks.

Specifications

CJ1W-INT01 Interrupt Input Unit (16 Points)

Name	16-point Interrupt Input Unit with Terminal Block
Model	CJ1W-INT01
Rated Input Voltage	24 VDC
Rated Input Voltage Range	20.4 to 26.4 VDC
Input Impedance	3.3 kΩ
Input Current	7 mA typical (at 24 VDC)
ON Voltage/ON Current	14.4 VDC min./3 mA min.
OFF Voltage/OFF Current	5 VDC max./1 mA max.
ON Response Time	0.05 ms max.
OFF Response Time	0.5 ms max.
Number of Circuits	16 (16 points/common, 1 circuit)
Number of Simultaneously ON Points	100% (16 points/common) simultaneously ON (24 VDC)
Insulation Resistance	20 MΩ between external terminals and GR terminal (at 100 VDC)
Dielectric Strength	1,000 VAC between external terminals and GR terminal for 1 minute at a leakage current of 10 mA max.
Internal Current Consumption	80 mA max.
Weight	110 g max.
Accessories	None

Circuit Configuration

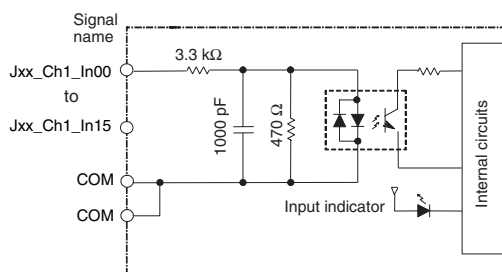

- Up to two Interrupt Input Units can be mounted to the CPU Rack. They must be connected as one of the five Units immediately next to the CPU Unit. If an Interrupt Input Unit is connected in any other position, an Incorrect Unit/Expansion Rack Connection error will occur.
- Set the pulse width of signals input to the Interrupt Input Unit so they satisfy the following conditions.
- The signal names of the terminals are the device variable names. The device variable names are the names that use "Jxx" as the device name.

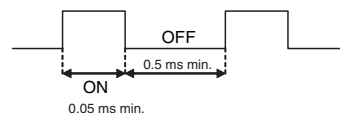
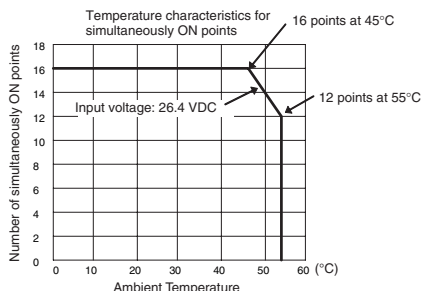

External connection and terminal-device variable diagram

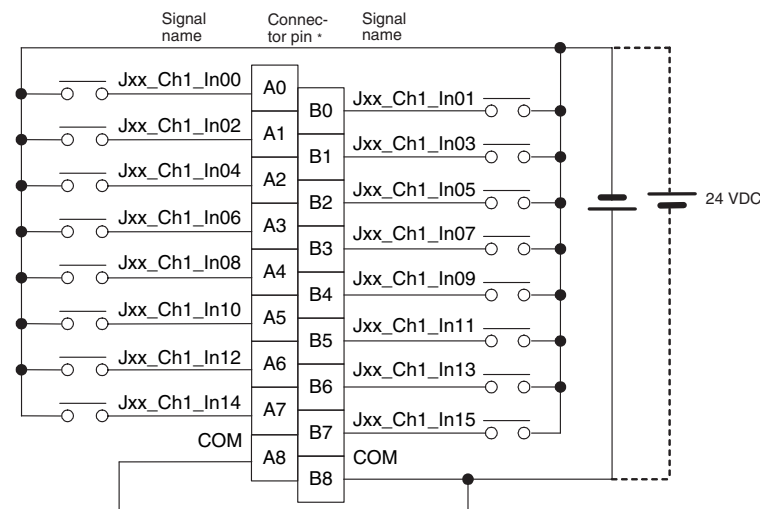

- The polarity can be connected in either direction.
- The signal names of the terminals are the device variable names. The device variable names are the names that use "Jxx" as the device name.

Note: With NJ-series Controllers, Interrupt Input Units can be used as normal Basic Input Units. They cannot be used to start I/O interrupt tasks.

* Terminal numbers A0 to A8 and B0 to B8 are used in the external connection and terminal-device variable diagrams. They are not printed on the Units.

External Interface

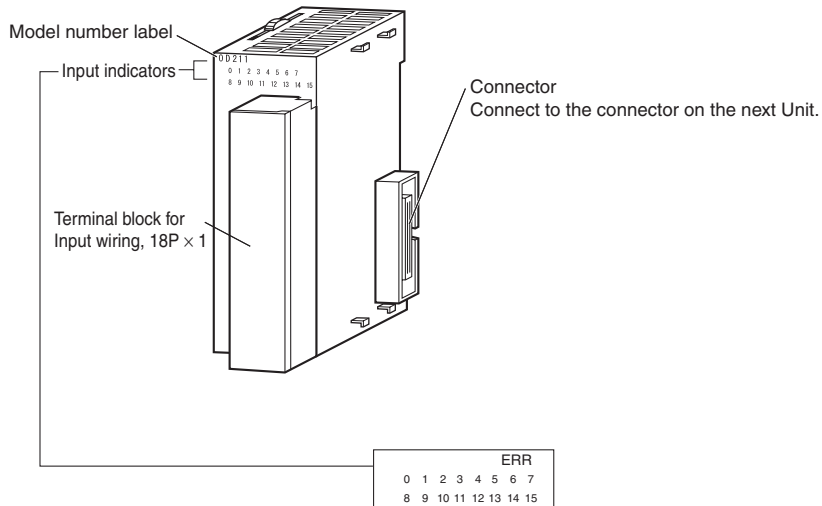

Wiring Terminal Blocks

Electric Wires

The following wire gauges are recommended.

Terminal Block Connector	Wire Size
18-terminal	AWG 22 to 18 (0.32 to 0.82 mm ²)

Crimp terminals

Use crimp terminals (M3) having the dimensions shown below.



Dimensions

(Unit: mm)

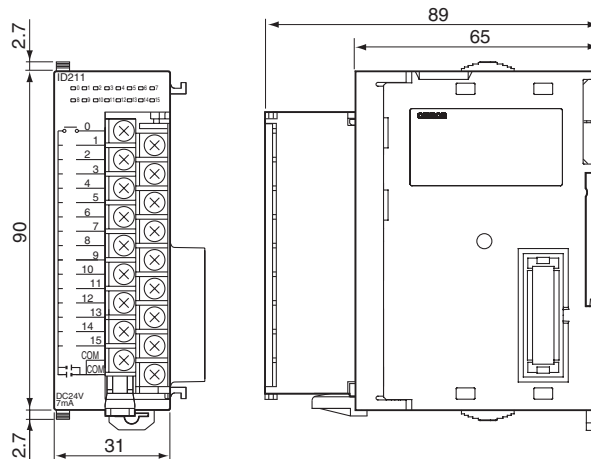

Related Manuals

Name	Cat. No.	Contents
CJ-series CJ2H-CPU6□-EIP, CJ2H-CPU6□, CJ2M-CPU□□ CJ2 CPU Unit Hardware User's Manual	W472	Describes the following for CJ2 CPU Units: <ul style="list-style-type: none"> • Overview and features • Basic system configuration • Part nomenclature and functions • Mounting and setting procedure • Remedies for errors • Also refer to the Software User's Manual (W473).
CJ Series CJ1H-CPU□□H-R, CJ1G/H-CPU□□H, CJ1G-CPU□□P, CJ1G-CPU□□, CJ1M-CPU□□ Programmable Controllers Operation Manual	W393	Provides an outlines of and describes the design, installation, maintenance, and other basic operations for the CJ-series PLCs.
NJ-series CPU Unit Hardware User's Manual NJ501-□□□□	W500	An introduction to the entire NJ-series system is provided along with the following information on a Controller built with an NJ501 CPU Unit. <ul style="list-style-type: none"> • Features and system configuration • Introduction • Part names and functions • General specifications • Installation and wiring • Maintenance and inspection Use this manual together with the NJ-series CPU Unit Software User's Manual (Cat. No. W501).

Read and Understand This Catalog

Please read and understand this catalog before purchasing the products. Please consult your OMRON representative if you have any questions or comments.

Warranty and Limitations of Liability

WARRANTY

OMRON's exclusive warranty is that the products are free from defects in materials and workmanship for a period of one year (or other period if specified) from date of sale by OMRON.

OMRON MAKES NO WARRANTY OR REPRESENTATION, EXPRESS OR IMPLIED, REGARDING NON-INFRINGEMENT, MERCHANTABILITY, OR FITNESS FOR PARTICULAR PURPOSE OF THE PRODUCTS. ANY BUYER OR USER ACKNOWLEDGES THAT THE BUYER OR USER ALONE HAS DETERMINED THAT THE PRODUCTS WILL SUITABLY MEET THE REQUIREMENTS OF THEIR INTENDED USE. OMRON DISCLAIMS ALL OTHER WARRANTIES, EXPRESS OR IMPLIED.

LIMITATIONS OF LIABILITY

OMRON SHALL NOT BE RESPONSIBLE FOR SPECIAL, INDIRECT, OR CONSEQUENTIAL DAMAGES, LOSS OF PROFITS OR COMMERCIAL LOSS IN ANY WAY CONNECTED WITH THE PRODUCTS, WHETHER SUCH CLAIM IS BASED ON CONTRACT, WARRANTY, NEGLIGENCE, OR STRICT LIABILITY.

In no event shall the responsibility of OMRON for any act exceed the individual price of the product on which liability is asserted.

IN NO EVENT SHALL OMRON BE RESPONSIBLE FOR WARRANTY, REPAIR, OR OTHER CLAIMS REGARDING THE PRODUCTS UNLESS OMRON'S ANALYSIS CONFIRMS THAT THE PRODUCTS WERE PROPERLY HANDLED, STORED, INSTALLED, AND MAINTAINED AND NOT SUBJECT TO CONTAMINATION, ABUSE, MISUSE, OR INAPPROPRIATE MODIFICATION OR REPAIR.

Application Considerations

SUITABILITY FOR USE

OMRON shall not be responsible for conformity with any standards, codes, or regulations that apply to the combination of products in the customer's application or use of the products.

At the customer's request, OMRON will provide applicable third party certification documents identifying ratings and limitations of use that apply to the products. This information by itself is not sufficient for a complete determination of the suitability of the products in combination with the end product, machine, system, or other application or use.

The following are some examples of applications for which particular attention must be given. This is not intended to be an exhaustive list of all possible uses of the products, nor is it intended to imply that the uses listed may be suitable for the products:

- Outdoor use, uses involving potential chemical contamination or electrical interference, or conditions or uses not described in this catalog.
- Nuclear energy control systems, combustion systems, railroad systems, aviation systems, medical equipment, amusement machines, vehicles, safety equipment, and installations subject to separate industry or government regulations.
- Systems, machines, and equipment that could present a risk to life or property.

Please know and observe all prohibitions of use applicable to the products.

NEVER USE THE PRODUCTS FOR AN APPLICATION INVOLVING SERIOUS RISK TO LIFE OR PROPERTY WITHOUT ENSURING THAT THE SYSTEM AS A WHOLE HAS BEEN DESIGNED TO ADDRESS THE RISKS, AND THAT THE OMRON PRODUCTS ARE PROPERLY RATED AND INSTALLED FOR THE INTENDED USE WITHIN THE OVERALL EQUIPMENT OR SYSTEM.

PROGRAMMABLE PRODUCTS

OMRON shall not be responsible for the user's programming of a programmable product, or any consequence thereof.

Disclaimers

CHANGE IN SPECIFICATIONS

Product specifications and accessories may be changed at any time based on improvements and other reasons.

It is our practice to change model numbers when published ratings or features are changed, or when significant construction changes are made. However, some specifications of the products may be changed without any notice. When in doubt, special model numbers may be assigned to fix or establish key specifications for your application on your request. Please consult with your OMRON representative at any time to confirm actual specifications of purchased products.

DIMENSIONS AND WEIGHTS

Dimensions and weights are nominal and are not to be used for manufacturing purposes, even when tolerances are shown.

PERFORMANCE DATA

Performance data given in this catalog is provided as a guide for the user in determining suitability and does not constitute a warranty. It may represent the result of OMRON's test conditions, and the users must correlate it to actual application requirements. Actual performance is subject to the OMRON Warranty and Limitations of Liability.

ERRORS AND OMISSIONS

The information in this document has been carefully checked and is believed to be accurate; however, no responsibility is assumed for clerical, typographical, or proofreading errors, or omissions.

2011.11

In the interest of product improvement, specifications are subject to change without notice.

OMRON Corporation
Industrial Automation Company

<http://www.ia.omron.com/>

(c)Copyright OMRON Corporation 2011 All Right Reserved.