



Chipsmall Limited consists of a professional team with an average of over 10 year of expertise in the distribution of electronic components. Based in Hongkong, we have already established firm and mutual-benefit business relationships with customers from,Europe,America and south Asia,supplying obsolete and hard-to-find components to meet their specific needs.

With the principle of “Quality Parts,Customers Priority,Honest Operation,and Considerate Service”,our business mainly focus on the distribution of electronic components. Line cards we deal with include Microchip,ALPS,ROHM,Xilinx,Pulse,ON,Everlight and Freescale. Main products comprise IC,Modules,Potentiometer,IC Socket,Relay,Connector.Our parts cover such applications as commercial,industrial, and automotives areas.

We are looking forward to setting up business relationship with you and hope to provide you with the best service and solution. Let us make a better world for our industry!



Contact us

Tel: +86-755-8981 8866 Fax: +86-755-8427 6832

Email & Skype: info@chipsmall.com Web: www.chipsmall.com

Address: A1208, Overseas Decoration Building, #122 Zhenhua RD., Futian, Shenzhen, China





MULTILAYER CERAMIC CHIP CAPACITORS



CKC Series Array Type Capacitors

Type: CKCM25
CKCL22
CKCL44
CKCA43

Issue date: April 2011



TDK MLCC
US Catalog

Version B11

REMINDERS

Please read before using this product

SAFETY REMINDERS



REMINDERS

1. If you intend to use a product listed in this catalog for a purpose that may cause loss of life or other damage, you must contact our company's sales window.
2. We may modify products or discontinue production of a product listed in this catalog without prior notification.
3. We provide "Delivery Specification" that explain precautions for the specifications and safety of each product listed in this catalog. We strongly recommend that you exchange these delivery specifications with customers that use one of these products.
4. If you plan to export a product listed in this catalog, keep in mind that it may be a restricted item according to the "Foreign Exchange and Foreign Trade Control Law". In such cases, it is necessary to acquire export permission in harmony with this law.
5. Any reproduction or transferring of the contents of this catalog is prohibited without prior permission from our company.
6. We are not responsible for problems that occur related to the intellectual property rights or other rights of our company or a third party when you use a product listed in this catalog. We do not grant license of these rights.
7. This catalog only applies to products purchased through our company or one of our company's official agencies. This catalog does not apply to products that are purchased through other third parties.



CKC Series

2 & 4 Elements Array Capacitors

Type: CKCM25 (C1310), CKCL22 (C2012), CKCL44 (C2012), CKCA43 (C3216)

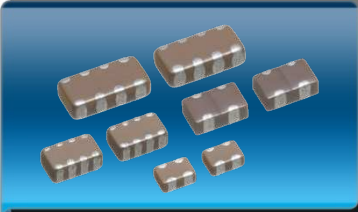

Features



- Multiple capacitors are fitted in a single product, contributing to reduced installation costs.
- The electrostatic capacity range and shape are designed to meet the demands of the cellular phone market.
- Reduced crosstalk (signal interference) between the terminals.

Shape & Dimensions



2 Elements Type

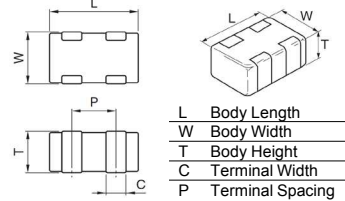

4 Elements Type

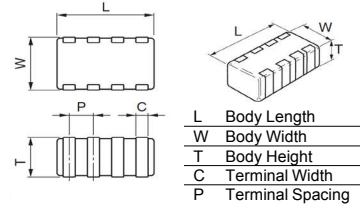

Applications



- Cellular telephone interface
- Interface cable circuit
- PC and peripherals
- CPU bus line
- High frequency circuit
- Noise bypass circuit



Part Number Construction

CKCM25 X7R 1E 103 M T XXXX

Series Name

Case Code	Length	Width
CKCM25	1.37 ± 0.15	1.00 ± 0.15
CKCL22	2.00 ± 0.15	1.25 ± 0.15
CKCL44	2.00 ± 0.15	1.25 ± 0.15
CKCA43	3.20 ± 0.20	1.60 ± 0.20

Temperature Characteristic

Temperature Characteristics	Capacitance Change	Temperature Range
C0G	0±30 ppm/°C	-55 to +125°C
X5R	±15%	-55 to +85°C
X7R	±15%	-55 to +125°C

Rated Voltage (DC)

Voltage Code	Voltage (DC)
0J	6.3V
1A	10V
1C	16V
1E	25V
1H	50V

Internal Codes

Packaging Style

Packaging Code	Style
T	Tape & Reel

Capacitance Tolerance

Tolerance Code	Tolerance
F	± 1%
K	± 10%
M	± 20%

Nominal Capacitance (pF)

The capacitance is expressed in three digit codes and in units of pico Farads (pF). The first and second digits identify the first and second significant figures of the capacitance. The third digit identifies the multiplier. R designates a decimal point.

Capacitance Code	Capacitance
0R5	0.5pF
010	1pF
102	1,000pF (1nF)
105	1,000,000pF (1µF)



Capacitance Range Chart

CKCM25 [EIA CC0504]

Capacitance Range Chart

Temperature Characteristics: C0G (0 ± 30 ppm/°C), X7R, (± 15%), X5R (± 15%)
 Rated Voltage: 50V (1H), 25V (1E), 16V (1C), 10V (1A), 6.3V (0J)

Capacitance (pF)	Cap Code	Tolerance	C0G		X7R		X5R		
			1H (50V)	1H (50V)	1E (25V)	1C (16V)	1A (10V)	0J (6.3V)	
10	100	F: ± 1%	█						
15	150	K: ± 10%	█						
22	220								
33	330								
47	470								
68	680								
100	101								
1,000	102	M: ± 20%		█					
2,200	222								
4,700	472								
10,000	103				█				
22,000	223					█			
47,000	473						█		
100,000	104							█	
220,000	224								█
470,000	474								█
1,000,000	105								█

Standard Thickness

█ 0.60 mm (Red)

█ 0.80 mm (Green)



Capacitance Range Table

CKCM25 [EIA CC0504]

Class 1 (Temperature Compensating)

Temperature Characteristics: C0G (-55 to 125°C, 0±30 ppm/°C)

TDK Part Number (Ordering Code)	Temperature Characteristics	Rated Voltage	Capacitance (pF)	Capacitance Tolerance	Thickness (mm)
CKCM25C0G1H100F	C0G	50V	10	± 1%	0.60 ± 0.06
CKCM25C0G1H150K	C0G	50V	15	± 10%	0.60 ± 0.06
CKCM25C0G1H220K	C0G	50V	22	± 10%	0.60 ± 0.06
CKCM25C0G1H330K	C0G	50V	33	± 10%	0.60 ± 0.06
CKCM25C0G1H470K	C0G	50V	47	± 10%	0.60 ± 0.06
CKCM25C0G1H680K	C0G	50V	68	± 10%	0.60 ± 0.06
CKCM25C0G1H101K	C0G	50V	100	± 10%	0.60 ± 0.06

Class 2 (Temperature Stable)

Temperature Characteristics: X7R (-55 to +125°C, ±15%), X5R (-55 to +85°C, ±15%)

TDK Part Number (Ordering Code)	Temperature Characteristics	Rated Voltage	Capacitance (pF)	Capacitance Tolerance	Thickness (mm)
CKCM25X7R1H102M	X7R	50V	1,000	± 20%	0.60 ± 0.06
CKCM25X7R1H222M	X7R	50V	2,200	± 20%	0.60 ± 0.06
CKCM25X7R1H472M	X7R	50V	4,700	± 20%	0.60 ± 0.06
CKCM25X7R1E103M	X7R	25V	10,000	± 20%	0.60 ± 0.06
CKCM25X5R1C223M	X5R	16V	22,000	± 20%	0.60 ± 0.06
CKCM25X5R1A473M	X5R	10V	47,000	± 20%	0.60 ± 0.06
CKCM25X5R0J104M	X5R	6.3V	100,000	± 20%	0.60 ± 0.06
CKCM25X5R0J224M	X5R	6.3V	220,000	± 20%	0.60 ± 0.06
CKCM25X5R0J474M	X5R	6.3V	470,000	± 20%	0.80 ± 0.10
CKCM25X5R0J105M	X5R	6.3V	1,000,000	± 20%	0.80 ± 0.10



Capacitance Range Chart

CKCL22 [EIA CC0805]

Capacitance Range Chart

Temperature Characteristics: C0G (0 ± 30 ppm/°C), X7R, (± 15%), X5R (± 15%)
 Rated Voltage: 50V (1H), 25V (1E), 16V (1C), 10V (1A), 6.3V (0J)

Capacitance (pF)	Cap Code	Tolerance	C0G		X7R		X5R		
			1H (50V)	1H (50V)	1E (25V)	1C (16V)	1A (10V)	0J (6.3V)	
10	100	F: ± 1%	█						
15	150	K: ± 10%	█						
22	220								
33	330								
47	470								
68	680								
100	101								
150	151								
220	221								
330	331								
470	471								
1,000	102	M: ± 20%		█					
2,200	222								
4,700	472								
10,000	103								
22,000	223								
47,000	473								
100,000	104					█			
220,000	224						█		
470,000	474							█	
1,000,000	105								█
2,200,000	225							█	

Standard Thickness
 0.85 ± 0.15 mm



Capacitance Range Table

CKCL22 [EIA CC0805]

Class 1 (Temperature Compensating)

Temperature Characteristics: C0G (-55 to 125°C, 0±30 ppm/°C)

TDK Part Number (Ordering Code)	Temperature Characteristics	Rated Voltage	Capacitance (pF)	Capacitance Tolerance	Thickness (mm)
CKCL22C0G1H100F	C0G	50V	10	± 1%	0.85 ± 0.10
CKCL22C0G1H150K	C0G	50V	15	± 10%	0.85 ± 0.10
CKCL22C0G1H220K	C0G	50V	22	± 10%	0.85 ± 0.10
CKCL22C0G1H330K	C0G	50V	33	± 10%	0.85 ± 0.10
CKCL22C0G1H470K	C0G	50V	47	± 10%	0.85 ± 0.10
CKCL22C0G1H680K	C0G	50V	68	± 10%	0.85 ± 0.10
CKCL22C0G1H101K	C0G	50V	100	± 10%	0.85 ± 0.10
CKCL22C0G1H151K	C0G	50V	150	± 10%	0.85 ± 0.10
CKCL22C0G1H221K	C0G	50V	220	± 10%	0.85 ± 0.10
CKCL22C0G1H331K	C0G	50V	330	± 10%	0.85 ± 0.10
CKCL22C0G1H471K	C0G	50V	470	± 10%	0.85 ± 0.10



Capacitance Range Table

CKCL22 [EIA CC0805]

Class 2 (Temperature Stable)

Temperature Characteristics: X7R (-55 to +125°C, ±15%), X5R (-55 to +85°C, ±15%)

TDK Part Number (Ordering Code)	Temperature Characteristics	Rated Voltage	Capacitance (pF)	Capacitance Tolerance	Thickness (mm)
CKCL22X7R1H102M	X7R	50V	1,000	± 20%	0.85 ± 0.10
CKCL22X7R1H222M	X7R	50V	2,200	± 20%	0.85 ± 0.10
CKCL22X7R1H472M	X7R	50V	4,700	± 20%	0.85 ± 0.10
CKCL22X7R1H103M	X7R	50V	10,000	± 20%	0.85 ± 0.10
CKCL22X7R1H223M	X7R	50V	22,000	± 20%	0.85 ± 0.10
CKCL22X7R1H473M	X7R	50V	47,000	± 20%	0.85 ± 0.10
CKCL22X7R1E104M	X7R	25V	100,000	± 20%	0.85 ± 0.10
CKCL22X5R1C224M	X5R	16V	220,000	± 20%	0.85 ± 0.10
CKCL22X5R1A474M	X5R	10V	470,000	± 20%	0.85 ± 0.10
CKCL22X5R0J105M	X5R	6.3V	1,000,000	± 20%	0.85 ± 0.10
CKCL22X5R0J225M	X5R	6.3V	2,200,000	± 20%	0.85 ± 0.10



Capacitance Range Chart

CKCL44 [EIA CC0805]

Capacitance Range Chart

Temperature Characteristics: C0G (0 ± 30 ppm/°C), X7R, (± 15%), X5R (± 15%)
 Rated Voltage: 50V (1H), 25V (1E), 16V (1C), 10V (1A), 6.3V (0J)

Capacitance (pF)	Cap Code	Tolerance	C0G		X7R		X5R	
			1H (50V)	1H (50V)	1E (25V)	1C (16V)	1A (10V)	0J (6.3V)
10	100	F: ± 1%	█					
15	150	K: ± 10%	█					
22	220							
33	330							
47	470							
68	680							
100	101							
150	151	M: ± 20%		█				
220	221							
470	471							
1,000	102							
2,200	222							
4,700	472							
10,000	103					█		
22,000	223						█	
47,000	473							█
100,000	104							█

Standard Thickness
 0.85 ± 0.15 mm



Capacitance Range Table

CKCL44 [EIA CC0805]

Class 1 (Temperature Compensating)

Temperature Characteristics: C0G (-55 to 125°C, 0±30 ppm/°C)

TDK Part Number (Ordering Code)	Temperature Characteristics	Rated Voltage	Capacitance (pF)	Capacitance Tolerance	Thickness (mm)
CKCL44C0G1H100F	C0G	50V	10	± 1%	0.85 ± 0.10
CKCL44C0G1H150K	C0G	50V	15	± 10%	0.85 ± 0.10
CKCL44C0G1H220K	C0G	50V	22	± 10%	0.85 ± 0.10
CKCL44C0G1H330K	C0G	50V	33	± 10%	0.85 ± 0.10
CKCL44C0G1H470K	C0G	50V	47	± 10%	0.85 ± 0.10
CKCL44C0G1H680K	C0G	50V	68	± 10%	0.85 ± 0.10
CKCL44C0G1H101K	C0G	50V	100	± 10%	0.85 ± 0.10
CKCL44C0G1H151K	C0G	50V	150	± 10%	0.85 ± 0.10

Class 2 (Temperature Stable)

Temperature Characteristics: X7R (-55 to +125°C, ±15%), X5R (-55 to +85°C, ±15%)

TDK Part Number (Ordering Code)	Temperature Characteristics	Rated Voltage	Capacitance (pF)	Capacitance Tolerance	Thickness (mm)
CKCL44X7R1H221M	X7R	50V	220	± 20%	0.85 ± 0.10
CKCL44X7R1H471M	X7R	50V	470	± 20%	0.85 ± 0.10
CKCL44X7R1H102M	X7R	50V	1,000	± 20%	0.85 ± 0.10
CKCL44X7R1H222M	X7R	50V	2,200	± 20%	0.85 ± 0.10
CKCL44X7R1H472M	X7R	50V	4,700	± 20%	0.85 ± 0.10
CKCL44X7R1E103M	X7R	25V	10,000	± 20%	0.85 ± 0.10
CKCL44X7R1C223M	X7R	16V	22,000	± 20%	0.85 ± 0.10
CKCL44X5R1A473M	X5R	10V	47,000	± 20%	0.85 ± 0.10
CKCL44X5R0J104M	X5R	6.3V	100,000	± 20%	0.85 ± 0.10



Capacitance Range Chart

CKCA43 [EIA CC1206]

Capacitance Range Chart

Temperature Characteristics: C0G (0 ± 30 ppm/°C), X7R, (± 15%), X5R (± 15%)
 Rated Voltage: 50V (1H), 25V (1E), 16V (1C), 10V (1A), 6.3V (0J)

Capacitance (pF)	Cap Code	Tolerance	C0G		X7R		X5R	
			1H (50V)	1H (50V)	1E (25V)	1C (16V)	1A (10V)	0J (6.3V)
10	100	F: ± 1%	█					
15	150	K: ± 10%	█					
22	220							
33	330							
47	470							
68	680							
100	101							
150	151							
220	221							
330	331							
470	471	K: ± 10%		█				
680	681	M: ± 20%		█				
1,000	102	M: ± 20%		█				
2,200	222							
4,700	472							
10,000	103							
22,000	223							
47,000	473					█		
100,000	104						█	
220,000	224						█	
470,000	474						█	
1,000,000	105						█	

Standard Thickness
 1.00 ± 0.10 mm



Capacitance Range Table

CKCA43 [EIA CC1206]

Class 1 (Temperature Compensating)

Temperature Characteristics: C0G (-55 to 125°C, 0±30 ppm/°C)

TDK Part Number (Ordering Code)	Temperature Characteristics	Rated Voltage	Capacitance (pF)	Capacitance Tolerance	Thickness (mm)
CKCA43C0G1H100F	C0G	50V	10	± 1%	1.00 ± 0.10
CKCA43C0G1H150K	C0G	50V	15	± 10%	1.00 ± 0.10
CKCA43C0G1H220K	C0G	50V	22	± 10%	1.00 ± 0.10
CKCA43C0G1H330K	C0G	50V	33	± 10%	1.00 ± 0.10
CKCA43C0G1H470K	C0G	50V	47	± 10%	1.00 ± 0.10
CKCA43C0G1H680K	C0G	50V	68	± 10%	1.00 ± 0.10
CKCA43C0G1H101K	C0G	50V	100	± 10%	1.00 ± 0.10
CKCA43C0G1H151K	C0G	50V	150	± 10%	1.00 ± 0.10
CKCA43C0G1H221K	C0G	50V	220	± 10%	1.00 ± 0.10
CKCA43C0G1H331K	C0G	50V	330	± 10%	1.00 ± 0.10
CKCA43C0G1H471K	C0G	50V	470	± 10%	1.00 ± 0.10
CKCA43C0G1H681K	C0G	50V	680	± 10%	1.00 ± 0.10
CKCA43C0G1H102K	C0G	50V	1,000	± 10%	1.00 ± 0.10



Capacitance Range Table

CKCA43 [EIA CC1206]

Class 2 (Temperature Stable)

Temperature Characteristics: X7R (-55 to +125°C, ±15%), X5R (-55 to +85°C, ±15%)

TDK Part Number (Ordering Code)	Temperature Characteristics	Rated Voltage	Capacitance (pF)	Capacitance Tolerance	Thickness (mm)
CKCA43X7R1H471M	X7R	50V	470	± 20%	1.00 ± 0.10
CKCA43X7R1H102M	X7R	50V	1,000	± 20%	1.00 ± 0.10
CKCA43X7R1H222M	X7R	50V	2,200	± 20%	1.00 ± 0.10
CKCA43X7R1H472M	X7R	50V	4,700	± 20%	1.00 ± 0.10
CKCA43X7R1H103M	X7R	50V	10,000	± 20%	1.00 ± 0.10
CKCA43X7R1H223M	X7R	50V	22,000	± 20%	1.00 ± 0.10
CKCA43X7R1E473M	X7R	25V	47,000	± 20%	1.00 ± 0.10
CKCA43X7R1C104M	X7R	16V	100,000	± 20%	1.00 ± 0.10
CKCA43X5R0J105M	X5R	6.3V	1,000,000	± 20%	1.00 ± 0.10



General Specifications

CKC Series – Array Type Capacitors

No.	Item	Performance	Test or Inspection Method													
1	External Appearance	No defects which may affect performance.	Inspect with magnifying glass (3×).													
2	Insulation Resistance	10,000MΩ min. As for the capacitors of rated voltage 16, 10, 6.3V DC, 100MΩ·μF min., whichever smaller.	To measure between each terminal. Apply rated voltage for 60s.													
3	Voltage Proof	Withstand test voltage without insulation breakdown or other damage.	<table border="1"> <thead> <tr> <th>Class</th> <th>Apply Voltage</th> </tr> </thead> <tbody> <tr> <td>Class 1</td> <td>3 x Rated Voltage</td> </tr> <tr> <td>Class 2</td> <td>2.5 x Rated Voltage</td> </tr> </tbody> </table> <p>Above DC voltage shall be applied across each terminal for 1 to 5s. Charge / discharge current shall not exceed 50mA.</p>	Class	Apply Voltage	Class 1	3 x Rated Voltage	Class 2	2.5 x Rated Voltage							
Class	Apply Voltage															
Class 1	3 x Rated Voltage															
Class 2	2.5 x Rated Voltage															
4	Capacitance	Within the specified tolerance.	<table border="1"> <thead> <tr> <th>Class</th> <th>Measuring Frequency</th> <th>Measuring Voltage</th> </tr> </thead> <tbody> <tr> <td>Class 1</td> <td>1MHz±10%</td> <td>0.5 - 5 V_{rms}</td> </tr> <tr> <td>Class 2</td> <td>1kHz±10%</td> <td>1.0±0.2V_{rms}</td> </tr> </tbody> </table> <p>To measure between each terminal.</p>	Class	Measuring Frequency	Measuring Voltage	Class 1	1MHz±10%	0.5 - 5 V _{rms}	Class 2	1kHz±10%	1.0±0.2V _{rms}				
Class	Measuring Frequency	Measuring Voltage														
Class 1	1MHz±10%	0.5 - 5 V _{rms}														
Class 2	1kHz±10%	1.0±0.2V _{rms}														
5	Q (Class 1)	<table border="1"> <thead> <tr> <th>Rated Capacitance</th> <th>Q</th> </tr> </thead> <tbody> <tr> <td>30pF and over</td> <td>1,000 min.</td> </tr> <tr> <td>Under 30pF</td> <td>400+20×C min.</td> </tr> </tbody> </table> <p>C : Rated capacitance (pF)</p>	Rated Capacitance	Q	30pF and over	1,000 min.	Under 30pF	400+20×C min.	See No.4 in this table for measuring condition.							
Rated Capacitance	Q															
30pF and over	1,000 min.															
Under 30pF	400+20×C min.															
6	Dissipation Factor (Class 2)	<table border="1"> <thead> <tr> <th>Rated Voltage (DC)</th> <th>D.F.</th> </tr> </thead> <tbody> <tr> <td>25V, 50V, 100V</td> <td>0.03 max.</td> </tr> <tr> <td>6.3V, 10V, 16V</td> <td>0.05 max.</td> </tr> </tbody> </table>	Rated Voltage (DC)	D.F.	25V, 50V, 100V	0.03 max.	6.3V, 10V, 16V	0.05 max.	See No.4 in this table for measuring condition.							
Rated Voltage (DC)	D.F.															
25V, 50V, 100V	0.03 max.															
6.3V, 10V, 16V	0.05 max.															
7	Temperature Characteristics of Capacitance (Class 1)	<table border="1"> <thead> <tr> <th>T.C.</th> <th>Temperature Coefficient</th> </tr> </thead> <tbody> <tr> <td>C0G</td> <td>0 ± 30 (ppm/°C)</td> </tr> </tbody> </table> <p>Capacitance drift within ± 0.2% or ± 0.05pF, whichever larger.</p>	T.C.	Temperature Coefficient	C0G	0 ± 30 (ppm/°C)	<p>Temperature coefficient shall be calculated based on values at 25°C and 85°C temperature.</p> <p>Measuring temperature below 20°C shall be -10°C and -25°C.</p>									
T.C.	Temperature Coefficient															
C0G	0 ± 30 (ppm/°C)															
8	Temperature Characteristics of Capacitance (Class 2)	<p>Capacitance Change (%)</p> <table border="1"> <thead> <tr> <th>No Voltage Applied</th> </tr> </thead> <tbody> <tr> <td>X5R: ± 15%</td> </tr> <tr> <td>X7R: ± 15%</td> </tr> </tbody> </table>	No Voltage Applied	X5R: ± 15%	X7R: ± 15%	<p>Capacitance shall be measured by the steps shown in the following table after thermal equilibrium is obtained for each step.</p> <p>ΔC be calculated ref. STEP3 reading</p> <table border="1"> <thead> <tr> <th>Step</th> <th>Temperature (°C)</th> </tr> </thead> <tbody> <tr> <td>1</td> <td>Reference temp. ± 2</td> </tr> <tr> <td>2</td> <td>Min. operating temp. ± 3</td> </tr> <tr> <td>3</td> <td>Reference temp. ± 2</td> </tr> <tr> <td>4</td> <td>Max. operating temp. ± 2</td> </tr> </tbody> </table> <p>Measuring voltage: 0.1, 0.2, 0.5, 1.0Vrms.</p>	Step	Temperature (°C)	1	Reference temp. ± 2	2	Min. operating temp. ± 3	3	Reference temp. ± 2	4	Max. operating temp. ± 2
No Voltage Applied																
X5R: ± 15%																
X7R: ± 15%																
Step	Temperature (°C)															
1	Reference temp. ± 2															
2	Min. operating temp. ± 3															
3	Reference temp. ± 2															
4	Max. operating temp. ± 2															

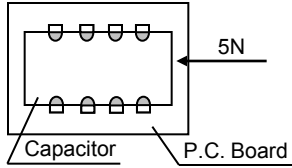
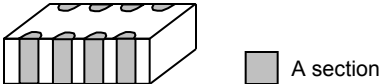

CKC Series – Array Type Capacitors

No.	Item	Performance	Test or Inspection Method									
9	Robustness of Terminations	No sign of termination coming off, breakage of ceramic, or other abnormal signs.	Reflow solder the capacitors on P.C. board (shown in Appendix 1 to 3) and apply a pushing force of 5N with 10 ± 1 s. 									
10	Solderability	New solder to cover over 75% of termination. 25% may have pin holes or rough spots but not concentrated in one spot. Ceramic surface of "A sections" shall not be exposed due to melting or shifting of termination material.	Completely soak both terminations in solder at $235 \pm 5^\circ\text{C}$ for 2 ± 0.5 s. Solder : H63A (JIS Z 3282) Flux : Isopropyl alcohol (JIS K 8839) Rosin (JIS K 5902) 25% solid solution.									
												
11	Vibration	No mechanical damage.	Reflow solder the capacitors on P.C. board (shown in Appendix 1 to 3) before testing. Vibrate the capacitor with amplitude of 1.5mm P-P sweeping the frequencies from 10Hz to 55Hz and back to 10Hz in about 1min. Repeat this for 2h each in 3 perpendicular directions.									
	External appearance											
	Capacitance	<table border="1"> <thead> <tr> <th colspan="2">Characteristics</th> <th>Change from the value before test</th> </tr> </thead> <tbody> <tr> <td>Class 1</td> <td>C0G</td> <td>$\pm 2.5\%$</td> </tr> <tr> <td>Class 2</td> <td>X5R X7R</td> <td>$\pm 7.5\%$</td> </tr> </tbody> </table>	Characteristics		Change from the value before test	Class 1	C0G	$\pm 2.5\%$	Class 2	X5R X7R	$\pm 7.5\%$	
Characteristics		Change from the value before test										
Class 1	C0G	$\pm 2.5\%$										
Class 2	X5R X7R	$\pm 7.5\%$										
	Q (Class 1)	<table border="1"> <thead> <tr> <th>Rated Capacitance</th> <th>Q</th> </tr> </thead> <tbody> <tr> <td>30pF and over</td> <td>1,000 min.</td> </tr> <tr> <td>Under 30pF</td> <td>$400 + 20 \times C$ min.</td> </tr> </tbody> </table> <p style="text-align: center;">C : Rated capacitance (pF)</p>	Rated Capacitance	Q	30pF and over	1,000 min.	Under 30pF	$400 + 20 \times C$ min.				
Rated Capacitance	Q											
30pF and over	1,000 min.											
Under 30pF	$400 + 20 \times C$ min.											
	D.F. (Class 2)	Meet the initial spec.										



General Specifications

CKC Series – Array Type Capacitors

No.	Item	Performance	Test or Inspection Method			
12	Temperature cycle		Reflow solder the capacitors on P.C. board (shown in Appendix 1 to 3) before testing. Expose the capacitors in the condition step1 through step 4 and repeat 5 times consecutively. Leave the capacitor in ambient conditions for 6 to 24h (Class 1) or 24±2h (Class 2) before measurement.			
	External appearance	No mechanical damage.				
	Capacitance	Characteristics		Change from the value before test		
		Class 1			C0G	±2.5%
		Class 2			X5R X7R	± 25 %
	Q (Class 1)	Rated Capacitance		Q		
		30pF and over			1,000 min.	
		Under 30pF			400+20×C min.	
	C : Rated capacitance (pF)					
	D.F. (Class 2)	Meet the initial spec.				
Insulation Resistance	Meet the initial spec.					
Voltage Proof	No insulation breakdown or other damage.					
13	Moisture Resistance (Steady State)		Reflow solder the capacitors on P.C. board (shown in Appendix 1 to 3) before testing. Leave at temperature 40±2°C, 90 to 95%RH for 500 +24,0h. Leave the capacitor in ambient conditions for 6 to 24h (Class 1) or 24±2h (Class 2) before measurement.			
	External appearance	No mechanical damage.				
	Capacitance	Characteristics		Change from the value before test		
		Class 1			C0G	±5%
		Class 2			X5R X7R	± 25 %
	Q (Class 1)	Rated Capacitance		Q		
		30pF and over			350 min.	
		10pF and over under 30pF			275+5/2×C min.	
		Under 10pF			200+10×C min.	
	C : Rated capacitance (pF)					
D.F. (Class 2)	Characteristics X7R: 200% of initial spec. max. X5R: 200% of initial spec. max					
Insulation Resistance	1,000MΩ min. (As for the capacitors of rated voltage 16, 10, 6.3V DC, 10MΩ•μF min.)					

Step	Temperature (°C)	Time (min.)
1	Min. operating temp. ±3	30 ± 3
2	Reference Temp. ± 2	2 - 5
3	Max. operating temp. ± 2	30 ± 2
4	Reference Temp. ± 2	2 - 5



General Specifications

CKC Series – Array Type Capacitors

No.	Item	Performance	Test or Inspection Method	
14	Moisture Resistance			
	External appearance	No mechanical damage.	Reflow solder the capacitors on P.C. board (shown in Appendix 1 to 3) before testing.	
	Capacitance	Characteristics		Apply the rated voltage at temperature $40 \pm 2^\circ\text{C}$ and 90 to 95%RH for 500 +24,0h. Charge/discharge current shall not exceed 50mA. Leave the capacitor in ambient conditions for 6 to 24h (Class 1) or $24 \pm 2\text{h}$ (Class 2) before measurement. Voltage conditioning (only for class 2): Voltage treat the capacitor under testing temperature and voltage for 1 hour. Leave the capacitor in ambient conditions for $24 \pm 2\text{h}$ before measurement. Use this measurement for initial value.
		Change from the value before test		
		Class 1	C0G	
	Class 2	X5R X7R	$\pm 25\%$	
	Q (Class 1)	Rated Capacitance		Q
30pF and over		200 min.		
Under 30pF		$100 + 10/3 \times C$ min.		
		C : Rated capacitance (pF)		
D.F. (Class 2)	Characteristics X7R: 200% of initial spec. max. X5R: 200% of initial spec. max.			
Insulation Resistance	500M Ω min. (As for the capacitors of rated voltage 16, 10, 6.3V DC, 5M Ω · μF min.)			
15	Life			
	External appearance	No mechanical damage.	Reflow solder the capacitors on P.C. board (shown in Appendix 1 to 3) before testing.	
	Capacitance	Characteristics		Below the voltage shall be applied at $125 \pm 2^\circ\text{C}$ for 1,000 +48, 0h. Applied voltage is 1xRV. Some items may be tested at higher voltage (1.2x, 1.5x or 2xRV). Charge/discharge current shall not exceed 50mA. Leave the capacitor in ambient conditions for 6 to 24h (Class 1) or $24 \pm 2\text{h}$ (Class 2) before measurement. Voltage conditioning: Voltage treat the capacitor under testing temperature and voltage for 1 hour. Leave the capacitor in ambient conditions for $24 \pm 2\text{h}$ before measurement. Use this measurement for initial value.
		Change from the value before test		
		Class 1	C0G	
	Class 2	X5R X7R	$\pm 25\%$	
	Q (Class 1)	Rated Capacitance		Q
30pF and over		350 min.		
10pF and over under 30pF		$275 + 5/2 \times C$ min.		
		Under 10pF		
		C : Rated capacitance (pF)		
D.F. (Class 2)	Characteristics X7R: 200% of initial spec. max. X5R: 200% of initial spec. max.			
Insulation Resistance	1,000M Ω min. (As for the capacitors of rated voltage 16, 10, 6.3V DC, 10M Ω · μF min.)			

*As for the initial measurement of capacitors (Class2) on number 8, 11, 12 and 13, leave capacitor at $150 - 10, 0^\circ\text{C}$ for 1 hour and measure the value after leaving capacitor for $24 \pm 2\text{h}$ in ambient condition.



CKC Series – Array Type Capacitors

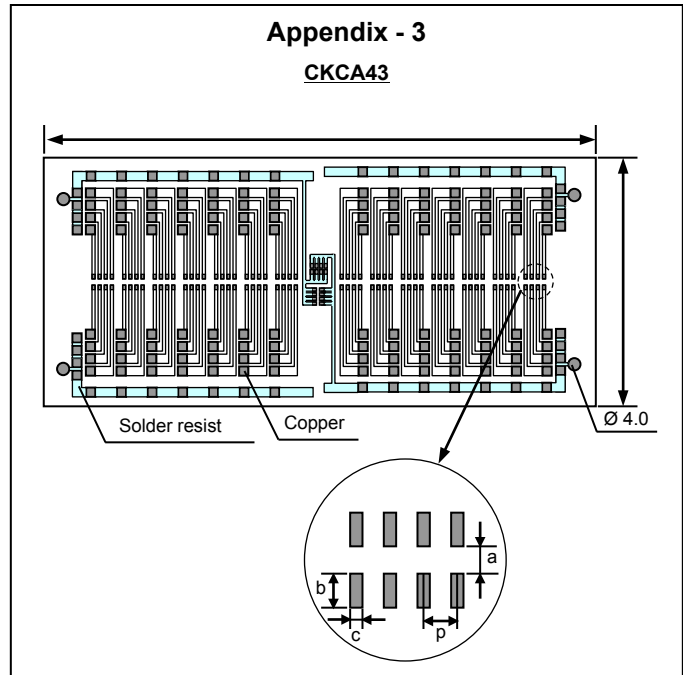
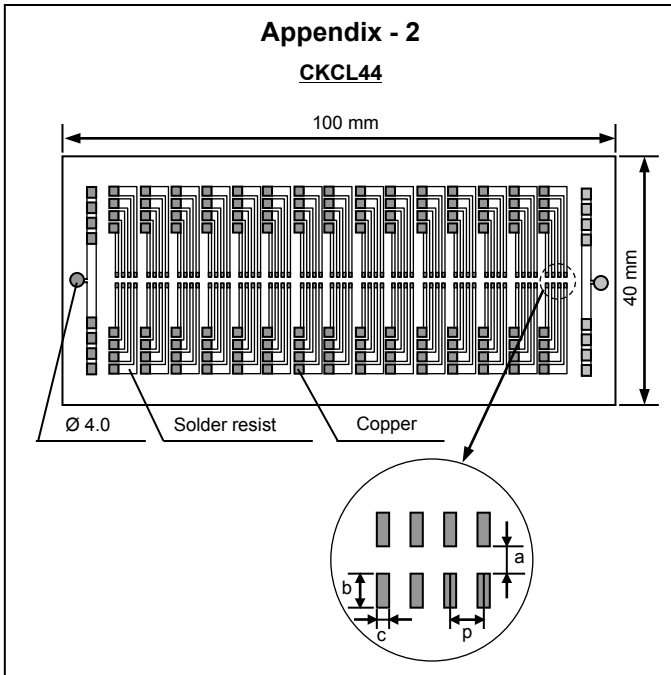
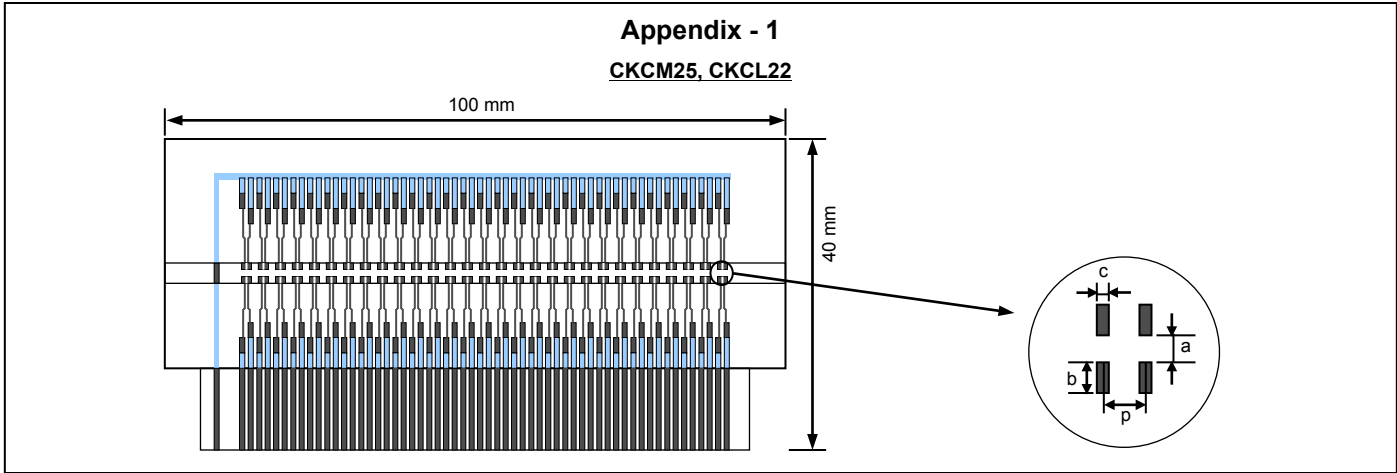

Material: Glass Epoxy (As per JIS C6484 GE4)

P.C. Board thickness: 1.6mm



Case Code			Dimensions (mm)			
Series	JIS	EIA	a	b	c	p
CKCM25	C1310	CC0504	0.5	0.5	0.36	0.64
CKCL22	C2012	CC0805	0.6	0.6	0.45	1.0
CKCL44	C2012	CC0805	0.6	0.7	0.2	0.5
CKCA43	C3216	CC1206	1.0	0.7	0.3	0.8



Soldering Information

CKC Series – Array Type Capacitors

Recommended Soldering Land Pattern

CKCM25 & CKCL22

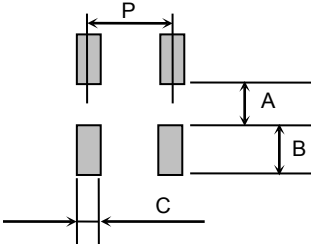

CKCL44 & CKCA43

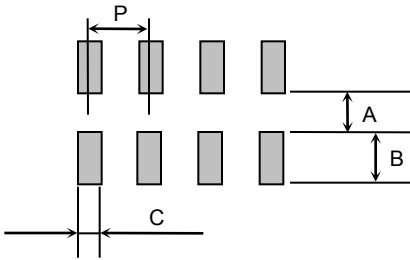

Recommended Soldering Profile

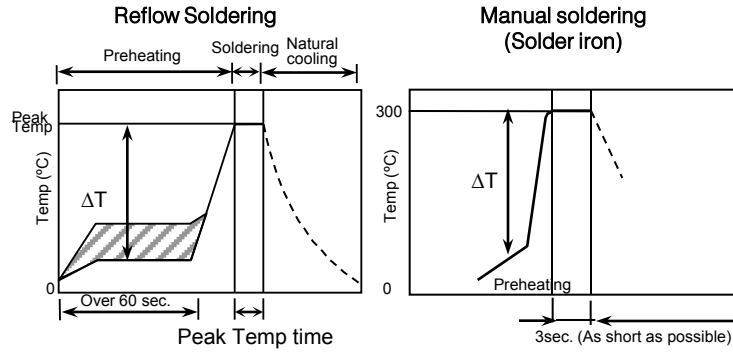

Recommended soldering duration

Solder	Temp./Dura.	Reflow Soldering	
		Peak temp (°C)	Duration (sec.)
Sn-Pb Solder		230 max.	20 max.
Lead-Free Solder		260 max.	10 max.

Recommended solder compositions

Sn-37Pb (Sn-Pb solder)

Sn-3.0Ag-0.5Cu (Lead Free Solder)

Reflow Soldering

Unit: mm

Type	CKCM25	CKCL22	CKCL44	CKCA43
P	0.64	1.0	0.5	0.8
A	0.3	0.4	0.55	0.6 ~ 0.7
B	0.45	0.6	0.6	0.8 ~ 1.0
C	0.3	0.5	0.25	0.4

Preheating Condition

Soldering Method	Temperature (°C)	
	CKCM25, CLCL22, CKCL44	CKCA43
Reflow soldering	$\Delta T \leq 150$	$\Delta T \leq 130$
Manual soldering	$\Delta T \leq 150$	$\Delta T \leq 130$

Recommended Solder Amount

Excessive solder Higher tensile force on the chip capacitor may cause cracking.

Adequate solder Maximum amount
Minimum amount

Insufficient solder Small solder fillet may cause contact failure or failure to hold the chip capacitor to the P.C. board.



Packaging Information

CKC Series – Array Type Capacitors

Carrier Tape Configuration

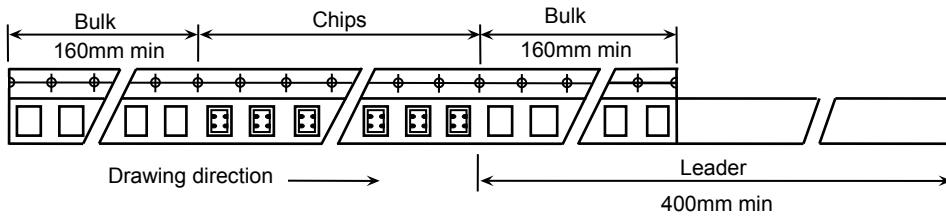

Peel Back Force (Top Tape)

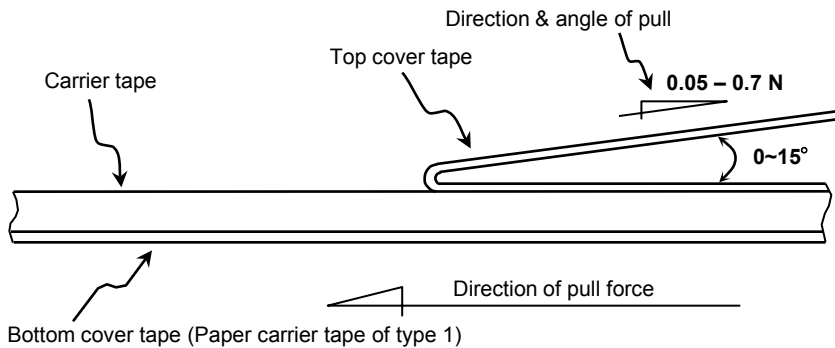

- Carrier tape shall be flexible enough to be wound around a minimum radius of 30mm with components in tape.
- The missing of components shall be less than 0.1%
- Components shall not stick to the cover tape.
- The cover tape shall not protrude beyond the edges of the carrier tape not shall cover the sprocket holes.

Chip Quantity Per Reel and Structure of Reel (Paper & Plastic)

Type 1: Paper Carrier Tape & Reel

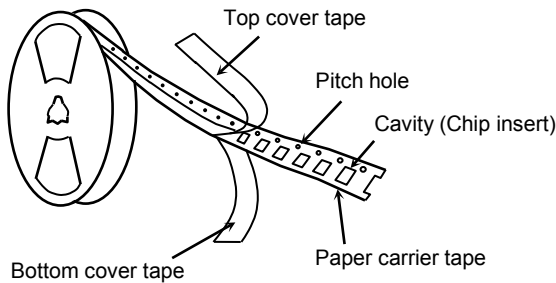

Type 2: Plastic Carrier Tape & Reel

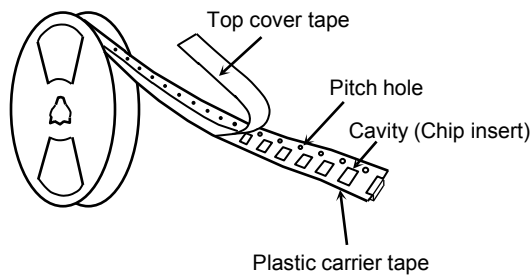

Case Code			Taping Material	Chip quantity (pcs.)	
Series	JIS	EIA		φ178mm (7") reel	φ330mm (13") reel
CKCM25	C1310	CC0504	Paper	4,000	10,000
CKCL22	C2012	CC0805	Paper		
CKCL44	C2012	CC0805	Paper		
CKCA43	C3216	CC1206	Paper	2,000	



Additional Information

CKC Series – Array Type Capacitors

• Inside Structure & Material System

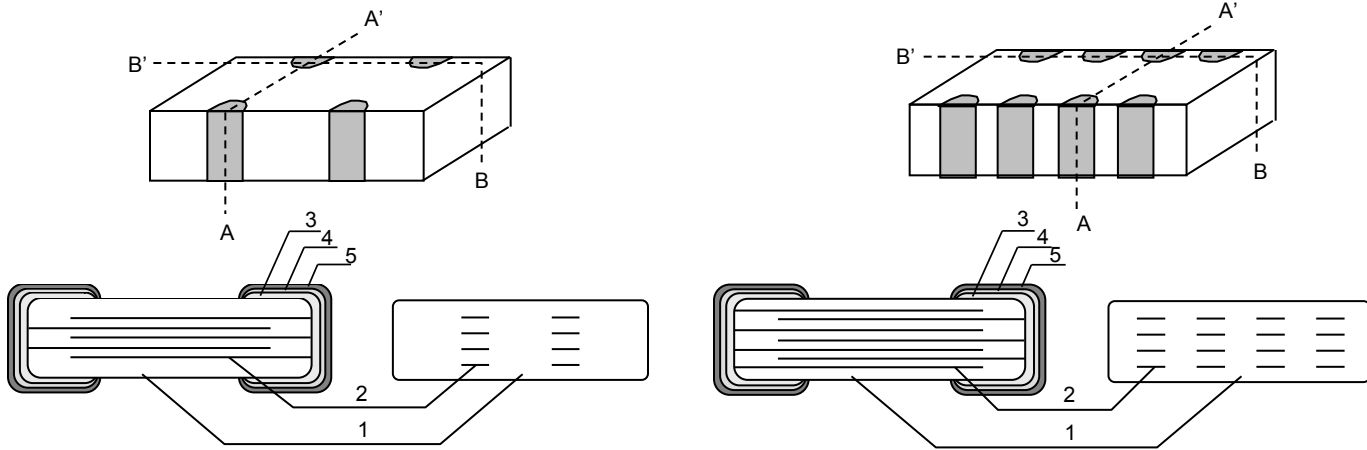

No.	NAME	MATERIAL	
		Class 1	Class 2
(1)	Ceramic Dielectric	CaZrO ₃	BaTiO ₃
(2)	Internal Electrode	Nickel (Ni)	
(3)	Termination	Copper (Cu)	
(4)		Nickel (Ni)	
(5)		Tin (Sn)	

• Shape & Dimensions

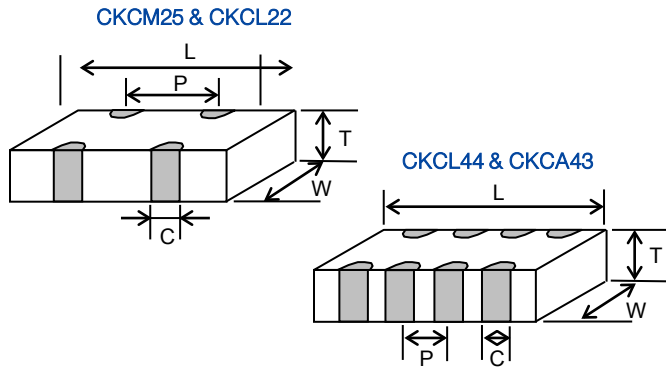

Case Code			Dimensions (mm)				
Series	JIS	EIA	L	W	T	P	C
CKCM25	C1310	CC0504	1.37	1.00	0.66 max 0.90 max	0.26 min.	0.10 min.
CKCL22	C2012	CC0805	2.00	1.25	0.85	0.35 min.	0.10 min.
CKCL44	C2012	CC0805	2.00	1.25	0.85	0.15 min.	0.10 min.
CKCA43	C3216	CC1206	3.20	1.60	1.00	0.30 min.	0.15 min.

• Environmental Information

TDK Corporation established internal product environmental assurance standards that include the six hazardous substances banned by the EU RoHS Directive¹ enforced on July 1, 2006 along with additional substances independently banned by TDK and has successfully completed making general purpose electronic components conform to the RoHS Directive².

1. Abbreviation for Restriction on Hazardous Substances, which refers to the regulation EU Directive 2002/95/EC on hazardous substances by the European Union (EU) effective from July 1, 2006. The Directive bans the use of six specific hazardous substances in electric and electronic devices and products handled within the EU. The six substances are lead, mercury, cadmium, hexavalent chromium, PBB (polybrominated biphenyls), and PBDE (polybrominated diphenyl ethers).
2. This means that, in conformity with the EU Directive 2002/95/EC, lead, cadmium, mercury, hexavalent chromium, and specific bromine-based flame retardants, PBB and PBDE, have not been used, except for exempted applications.

For REACH (SVHC : 15 substances according to ECHA / October 2008) : All TDK MLCC do not contain these 15 substances.

For European Directive 2000/53/CE and 2005/673/CE : Cadmium, Hexavalent Chromium, Mercury, Lead are not contained in all TDK MLCC.

For European Directive 2003/11/CE : Pentabromodiphenyl-ether, Octabromodiphenyl-ether are not contained in all TDK MLCC.