



Chipsmall Limited consists of a professional team with an average of over 10 year of expertise in the distribution of electronic components. Based in Hongkong, we have already established firm and mutual-benefit business relationships with customers from,Europe,America and south Asia,supplying obsolete and hard-to-find components to meet their specific needs.

With the principle of “Quality Parts,Customers Priority,Honest Operation,and Considerate Service”,our business mainly focus on the distribution of electronic components. Line cards we deal with include Microchip,ALPS,ROHM,Xilinx,Pulse,ON,Everlight and Freescale. Main products comprise IC,Modules,Potentiometer,IC Socket,Relay,Connector.Our parts cover such applications as commercial,industrial, and automotives areas.

We are looking forward to setting up business relationship with you and hope to provide you with the best service and solution. Let us make a better world for our industry!



Contact us

Tel: +86-755-8981 8866 Fax: +86-755-8427 6832

Email & Skype: info@chipsmall.com Web: www.chipsmall.com

Address: A1208, Overseas Decoration Building, #122 Zhenhua RD., Futian, Shenzhen, China



Cree® PLCC4 3 in 1 SMD LED

CLV1A-FKB

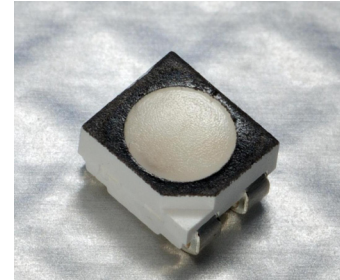

PRODUCT DESCRIPTION

Cree PLCC full-color LEDs offer high-intensity light output and a wide viewing angle in an industry-standard package. Designed to work in a wide array of environmental conditions, Cree PLCC full-color LEDs are suited for indoor video screen, decorative lighting and amusement applications.

FEATURES

- Size (mm): 3.2 x 2.8
- Dominant Wavelength:
Red (619 - 624nm)
Green (520 - 535nm)
Blue (460 - 475nm)
- Luminous Intensity (mcd)
Red (505 - 1010)
Green (900 - 2240)
Blue (224 - 450)
- Moisture Sensitivity Level: 5a
- Lead-Free
- RoHS Compliant

APPLICATIONS

- Full-Color Video Screen
- Decorative lighting
- Amusement

ABSOLUTE MAXIMUM RATINGS ($T_A = 25^\circ\text{C}$)

| Items | Symbol | Absolute Maximum Rating | | | Unit |
|--|------------|-------------------------|-----|-----|---------------------------|
| | | R | G | B | |
| Forward Current ^{Note 1} | I_F | 50 | 25 | 25 | mA |
| Peak Forward Current ^{Note 2} | I_{FP} | 200 | 100 | 100 | mA |
| Reverse Voltage | V_R | 5 | 5 | 5 | V |
| Power Dissipation | P_D | 130 | 100 | 100 | mW |
| Operation Temperature | T_{opr} | -40 ~ +85 | | | $^\circ\text{C}$ |
| Storage Temperature | T_{stg} | -40 ~ +100 | | | $^\circ\text{C}$ |
| Junction Temperature | T_J | 110 | 110 | 110 | $^\circ\text{C}$ |
| Junction/ambient 1 chip on | R_{THJA} | 450 | 400 | 450 | $^\circ\text{C}/\text{W}$ |
| Junction/ambient 3 chips on | R_{THJA} | 650 | 580 | 680 | $^\circ\text{C}/\text{W}$ |
| Junction/solder point 1 chip on | R_{THJS} | 300 | 280 | 300 | $^\circ\text{C}/\text{W}$ |
| Junction/solder point 3 chips on | R_{THJS} | 450 | 430 | 480 | $^\circ\text{C}/\text{W}$ |

Note: 1.Single-color light.
2.Pulse width ≤ 0.1 msec, duty $\leq 1/10$.

TYPICAL ELECTRICAL & OPTICAL CHARACTERISTICS ($T_A = 25^\circ\text{C}$)

| Characteristics | Condition | Symbol | Values | | | Unit |
|---|---------------|------------------|---------|---------|---------|---------------|
| | | | R | G | B | |
| Dominant Wavelength | $I_F = 20$ mA | λ_{DOM} | 619~624 | 520~535 | 460~475 | nm |
| Spectral bandwidth at 50% I_{REL} max | $I_F = 20$ mA | $\Delta \lambda$ | 24 | 38 | 28 | nm |
| Forward Voltage | $I_F = 20$ mA | $V_{F(avg)}$ | 2.0 | 3.2 | 3.2 | V |
| | | $V_{F(max)}$ | 2.6 | 4.0 | 4.0 | V |
| Luminous Intensity | $I_F = 20$ mA | $I_{V(min)}$ | 505 | 900 | 224 | mcd |
| | | $I_{V(avg)}$ | 710 | 1450 | 310 | mcd |
| Reverse Current (max) | $V_R = 5$ V | I_R | 10 | 10 | 10 | μA |

INTENSITY BIN LIMIT ($I_F = 20 \text{ mA}$)

Red

| Bin Code | Min.(mcd) | Max.(mcd) |
|----------|-----------|-----------|
| km | 505 | 635 |
| K | 560 | 710 |
| np | 635 | 805 |
| M | 710 | 900 |
| qr | 805 | 1010 |

Green

| Bin Code | Min.(mcd) | Max.(mcd) |
|----------|-----------|-----------|
| N | 900 | 1120 |
| st | 1010 | 1260 |
| P | 1120 | 1400 |
| vw | 1260 | 1600 |
| Q | 1400 | 1800 |
| xy | 1600 | 2020 |
| R | 1800 | 2240 |

Blue

| Bin Code | Min.(mcd) | Max.(mcd) |
|----------|-----------|-----------|
| F | 224 | 280 |
| de | 252 | 318 |
| G | 280 | 355 |
| fg | 318 | 403 |
| H | 355 | 450 |

Tolerance of measurement of luminous intensity is $\pm 10\%$.

COLOR BIN LIMIT ($I_F = 20 \text{ mA}$)

Red

| Bin Code | Min.(nm) | Max.(nm) |
|----------|----------|----------|
| RB | 619 | 624 |

Green

| Bin Code | Min.(nm) | Max.(nm) |
|----------|----------|----------|
| G7 | 520 | 525 |
| G23 | 522.5 | 527.5 |
| G8 | 525 | 530 |
| G45 | 527.5 | 532.5 |
| G9 | 530 | 535 |

Blue

| Bin Code | Min.(nm) | Max.(nm) |
|----------|----------|----------|
| B3 | 460 | 465 |
| B23 | 462.5 | 467.5 |
| B4 | 465 | 470 |
| B45 | 467.5 | 472.5 |
| B5 | 470 | 475 |

Tolerance of measurement of dominant wavelength is $\pm 1 \text{ nm}$.

ORDER CODE TABLE*

| Kit Number | Color | Luminous Intensity (mcd) | | Dominant Wavelength (nm) | | | | Package |
|----------------------------|-------|---|------|--------------------------------------|-----------|-----------|-----------|---------|
| | | Min. | Max. | Color Bin | Min. (nm) | Color Bin | Max. (nm) | |
| CLV1A-FKB-CkmqrNRFHBB79353 | Red | 505 | 1010 | RB | 619 | RB | 624 | Reel |
| | Green | 900 | 2240 | G7 | 520 | G9 | 535 | Reel |
| | Blue | 224 | 450 | B3 | 460 | B5 | 475 | Reel |
| CLV1A-FKB-Ckm1P1F1BB7C3C3 | Red | Any 1 Intensity bin from km(505) - qr(1010) | | RB | 619 | RB | 624 | Reel |
| | Green | Any 1 Intensity bin from P(1120) - R(2240) | | Any 1 hue bin from G7(520) - G9(535) | | | | Reel |
| | Blue | Any 1 Intensity bin from F(224) - H(450) | | Any 1 hue bin from B3(460) - B5(475) | | | | Reel |
| CLV1A-FKB-CK1vw1de1BB7C3C3 | Red | Any 1 Intensity bin from K(560) - qr(1010) | | RB | 619 | RB | 624 | Reel |
| | Green | Any 1 Intensity bin from vw(1260) - R(2240) | | Any 1 hue bin from G7(520) - G9(535) | | | | Reel |
| | Blue | Any 1 Intensity bin from de(252) - H(450) | | Any 1 hue bin from B3(460) - B5(475) | | | | Reel |

Notes:

1. The above kit numbers represent the order codes which include multiple intensity-bin and color-bin codes. Only one intensity-bin code and one color-bin code will be shipped on each reel. Single intensity-bin code and single color-bin code will be orderable in certain quantities. For example, any 1 intensity bin from P - R means only 1 intensity bin (P or vw or Q or xy or R) will be shipped by Cree. For example, any 1 color bin from G7 - G9 means only 1 color bin (G7 or G23 or G8 or G45 or G9) will be shipped by Cree.
2. Please refer to the "Cree LED Lamp Reliability Test Standards" document for reliability test conditions.
3. Please refer to the "Cree LED Lamp Soldering & Handling" document for information about how to use this LED product safely.

GRAPHS

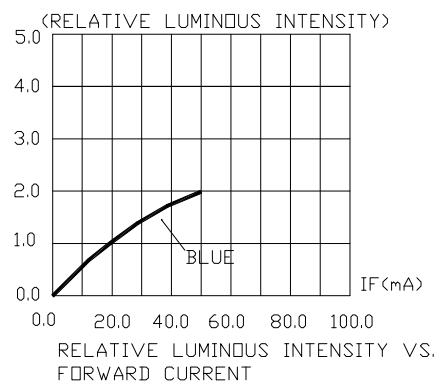
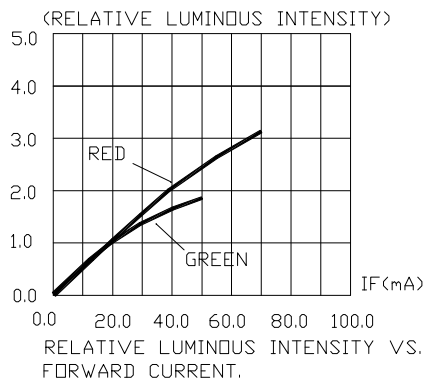
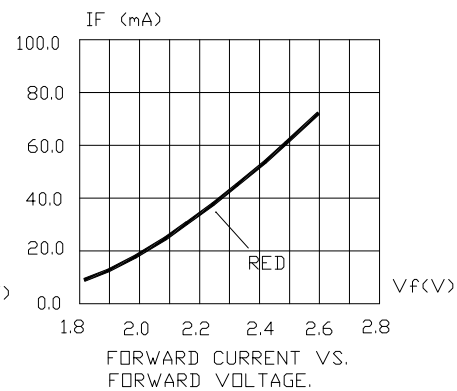
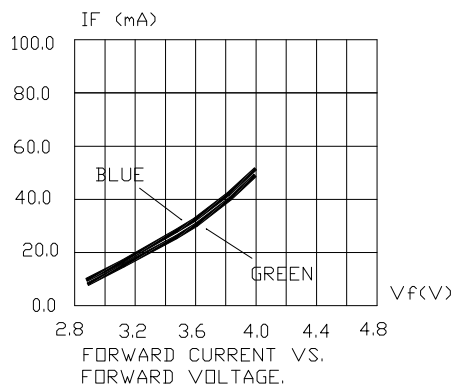
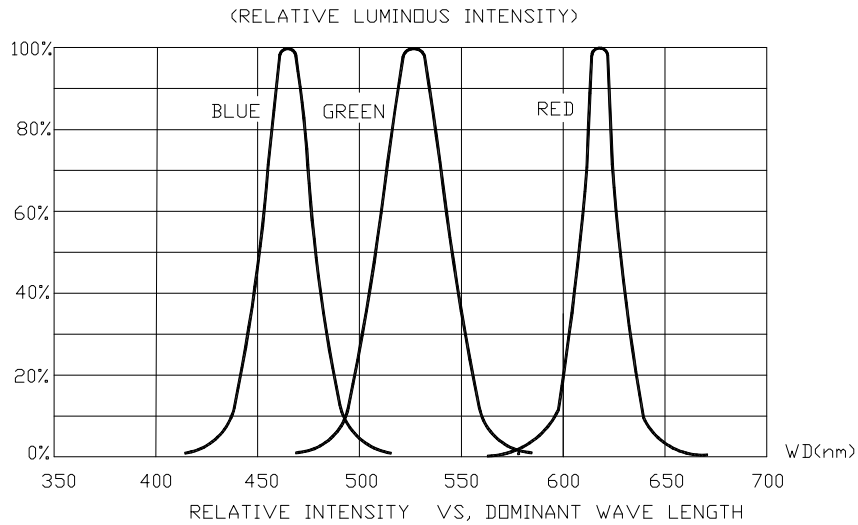

The above data are collected from statistical figures that do not necessarily correspond to the actual parameters of each single LED. Hence, these data will be changed without further notice.

GRAPHS

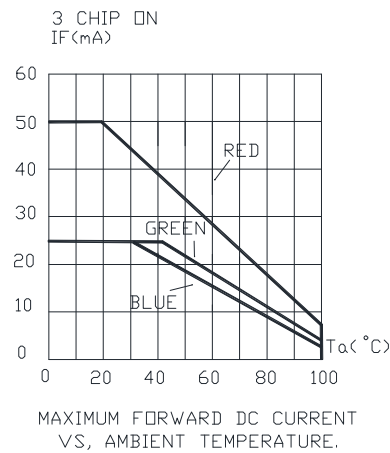
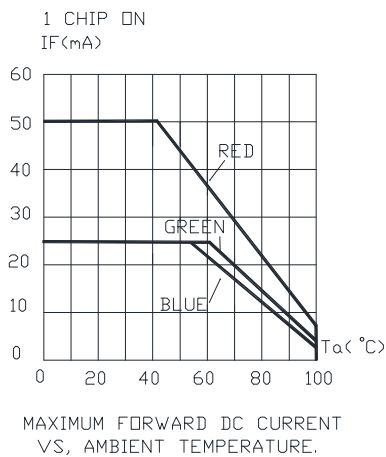
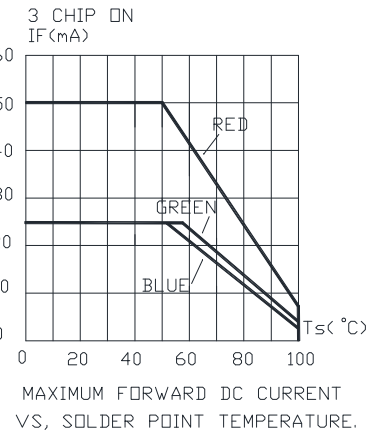
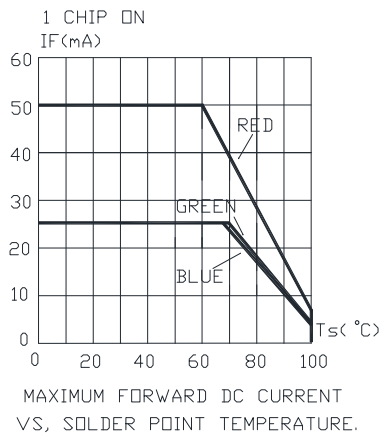
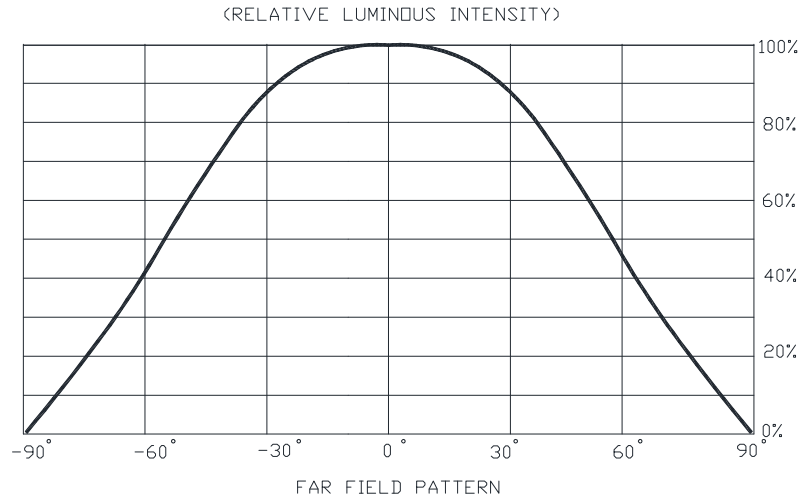

The above data are collected from statistical figures that do not necessarily correspond to the actual parameters of each single LED. Hence, these data will be changed without further notice.

MECHANICAL DIMENSIONS

All dimensions are in mm.

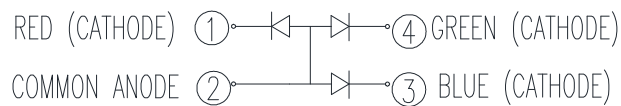
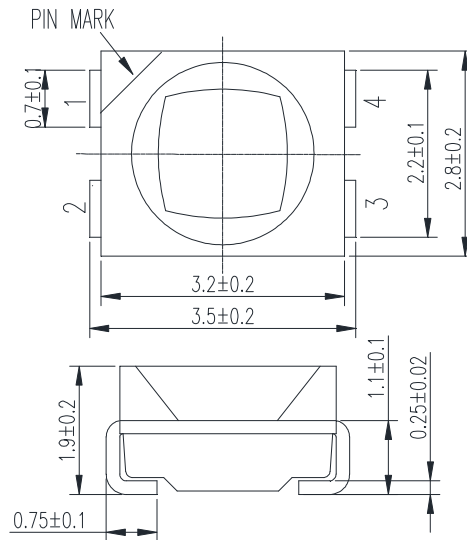

NOTES

RoHS Compliance

The levels of environmentally sensitive, persistent biologically toxic (PBT), persistent organic pollutants (POP), or otherwise restricted materials in this product are below the maximum concentration values (also referred to as the threshold limits) permitted for such substances, or are used in an exempted application, in accordance with EU Directive 2002/95/EC on the restriction of the use of certain hazardous substances in electrical and electronic equipment (RoHS), as amended through April 21, 2006.

Vision Advisory Claim

Users should be cautioned not to stare at the light of this LED product. The bright light can damage the eye.

KIT NUMBER SYSTEM

Cree LED lamps are tested and sorted into performance bins. A bin is specified by ranges of color, forward voltage, and brightness. Sorted LEDs are packaged for shipping in various convenient options. Please refer to the "Cree LED Lamp Packaging Standard" document for more information about shipping and packaging options.

Cree LEDs are sold by order codes in combinations of bins called kits. Order codes are configured in the following manner:

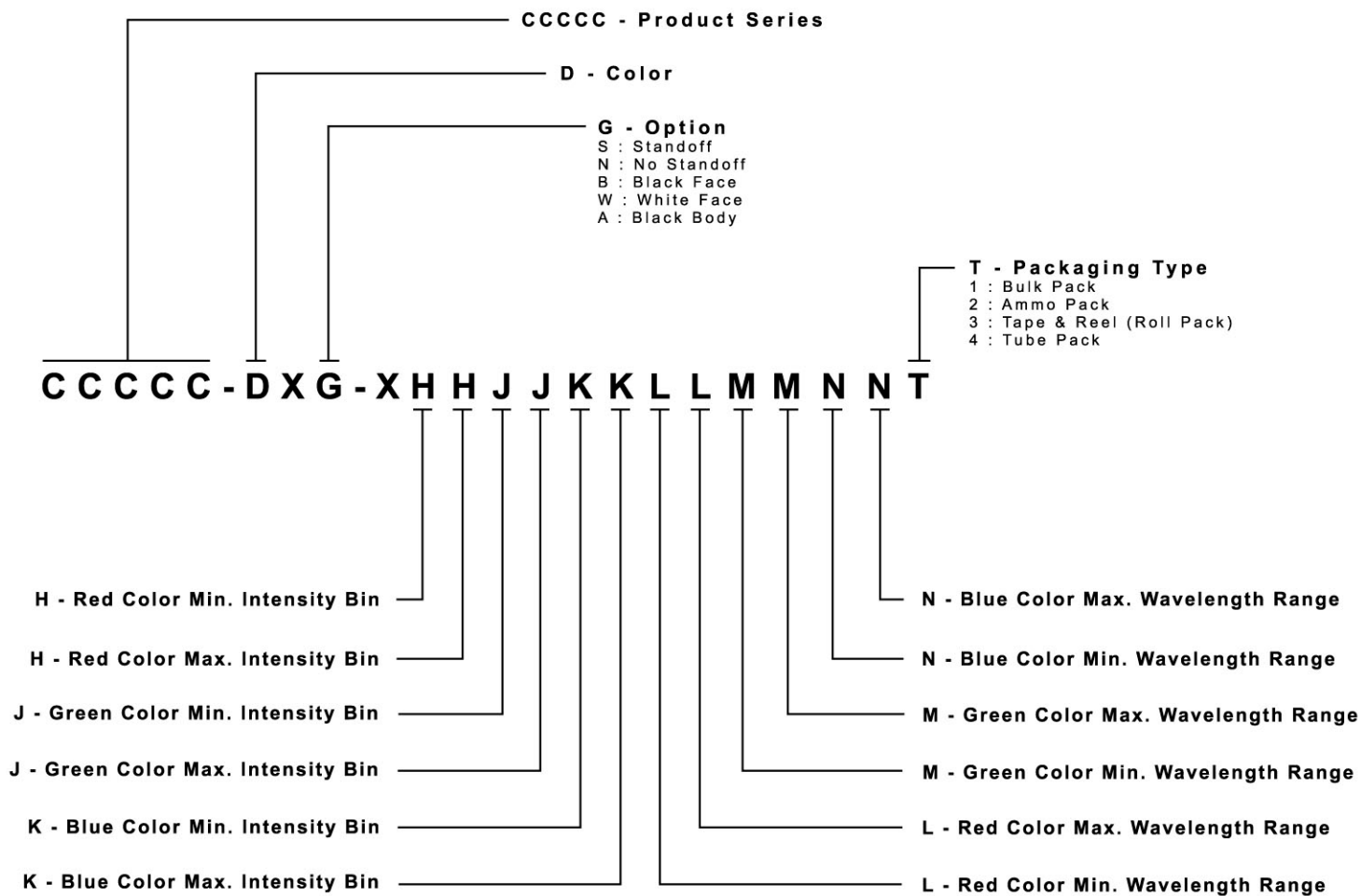

PACKAGING

- The CLV1A-FKB is rated as a MSL 5a product.
- The boxes are not water resistant and they must be kept away from water and moisture.
- The LEDs are packed in cardboard boxes after packaging in normal or anti-electrostatic bags.
- Cardboard boxes will be used to protect the LEDs from mechanical shocks during transportation.
- The reel pack is applied in SMD LED.
- Max 2000 pcs per reel.

