



Chipsmall Limited consists of a professional team with an average of over 10 year of expertise in the distribution of electronic components. Based in Hongkong, we have already established firm and mutual-benefit business relationships with customers from,Europe,America and south Asia,supplying obsolete and hard-to-find components to meet their specific needs.

With the principle of “Quality Parts,Customers Priority,Honest Operation,and Considerate Service”,our business mainly focus on the distribution of electronic components. Line cards we deal with include Microchip,ALPS,ROHM,Xilinx,Pulse,ON,Everlight and Freescale. Main products comprise IC,Modules,Potentiometer,IC Socket,Relay,Connector.Our parts cover such applications as commercial,industrial, and automotives areas.

We are looking forward to setting up business relationship with you and hope to provide you with the best service and solution. Let us make a better world for our industry!



Contact us

Tel: +86-755-8981 8866 Fax: +86-755-8427 6832

Email & Skype: info@chipsmall.com Web: www.chipsmall.com

Address: A1208, Overseas Decoration Building, #122 Zhenhua RD., Futian, Shenzhen, China





Praetorian® 6-Channel EMI Filter Array with ESD Protection

CM1453-06CP

Features

- Six channels of EMI filtering
- $\pm 15\text{kV}$ ESD protection (IEC 61000-4-2, contact discharge)
- $\pm 30\text{kV}$ ESD protection (HBM)
- Greater than -40dB of attenuation at 1GHz
- Chip Scale Package (CSP) with 0.40mm pitch and 0.25mm CSP solder ball which features extremely low parasitic inductance for optimum filter and ESD performance
- *OptiGuard*™ Coating for improved reliability at assembly
- RoHS compliant

Applications

- LCD and Camera data lines in mobile handsets
- I/O port protection for mobile handsets, notebook computers, PDAs etc.
- EMI filtering for data ports in cell phones, PDAs or notebook computers.
- Wireless handsets
- Handheld PCs/PDAs
- LCD and camera modules

Product Description

The CM1453-06CP is a pi-style EMI filter array with ESD protection, which integrates filters (C-L-C) in CSP form factor with 0.40mm pitch. Each EMI filter channel of the CM1453-06CP is implemented as a 3-pole L-C filter where the component values are 9.5pF-20nH-9.5pF. The roll-off frequency at -6dB attenuation is 380MHz and can be used in applications where the data rates are as high as 160Mbps while providing greater than -35dB over the 800MHz to 2.7GHz frequency range. The parts include ESD diodes on every I/O pin, and provide a high level of protection against electrostatic discharge (ESD). The ESD protection diodes connected to the filter ports are designed and characterized to safely dissipate ESD strikes of $\pm 15\text{kV}$, beyond the maximum requirement of the IEC61000-4-2 international standard. Using the MIL-STD-883 (Method 3015) specification for Human Body Model (HBM) ESD, the pins are protected for contact discharges at greater than $\pm 30\text{kV}$.

This device is particularly well suited for wireless handsets, mobile LCD modules and PDAs because of its small package format and easy-to-use pin assignments. In particular, the CM1453-06CP is ideal for EMI filtering and protecting data and control lines for the LCD display and camera interface in mobile handsets.

The CM1453-06CP incorporates *OptiGuard*™ which results in improved reliability at assembly. It is manufactured with a 0.40mm pitch and 0.25mm CSP solder ball to provide up to 28% board space savings vs. competing CSP devices with 0.50mm pitch and 0.30mm CSP solder ball.

Electrical Schematic

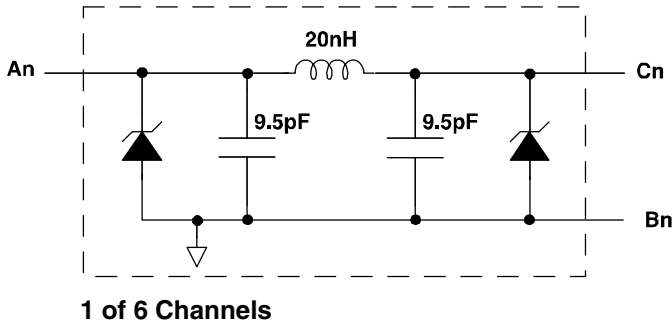

PACKAGE / PINOUT DIAGRAMS

TOP VIEW
(Bumps Down View)

BOTTOM VIEW
(Bumps Up View)

CM1453-06CP
15-bump CSP

Notes:
1) These drawings are not to scale.

PIN DESCRIPTIONS

PIN NUMBER	PIN DESCRIPTION	PIN NUMBER	PIN DESCRIPTION
A1	Filter #1	C1	Filter #1
A2	Filter #2	C2	Filter #2
A3	Filter #3	C3	Filter #3
A4	Filter #4	C4	Filter #4
A5	Filter #5	C5	Filter #5
A6	Filter #6	C6	Filter #6
B1	GND		—
B2	GND		—
B3	GND		—

CM1453-06CP

Ordering Information

PART NUMBERING INFORMATION			
Bumps	Package	Lead-free Finish	
		Ordering Part Number ¹	Part Marking
15	CSP	CM1453-06CP	N536

Note 1: Parts are shipped in Tape & Reel form unless otherwise specified.

Specifications

ABSOLUTE MAXIMUM RATINGS		
PARAMETER	RATING	UNITS
Storage Temperature Range	-65 to +150	°C
DC current per Inductor	30	mA
DC Package Power Rating	0.5	W

STANDARD OPERATING CONDITIONS		
PARAMETER	RATING	UNITS
Operating Temperature Range	-40 to +85	°C

ELECTRICAL OPERATING CHARACTERISTICS (NOTE 1)

SYMBOL	PARAMETER	CONDITIONS	MIN	TYP	MAX	UNITS
L_{TOT}	Total Channel Inductance			20		nH
C_{TOT}	Total Channel Capacitance ($C_1 \times 2$)	2.5V dc; 1MHz, 30mV ac	15.2	19	22.8	pF
C_1	Capacitance	2.5V dc; 1MHz, 30mV ac		9.5		pF
V_{ST}	Stand-off Voltage	$I = 10\mu A$	5.5			V
I_{LEAK}	Diode Leakage Current	$V_{IN} = 3.3V$		0.1	1.0	μA
V_{SIG}	Signal Clamp Voltage Positive Clamp Negative Clamp	$I_{LOAD} = 10mA$ $I_{LOAD} = -10mA$	5.6 -1.5	6.8 -0.8	9.0 -0.4	V V
V_{ESD}	In-system ESD Withstand Voltage a) Human Body Model, MIL-STD-883, Method 3015 b) Contact Discharge per IEC 61000-4-2 Level 4	Notes 2 and 3	± 30 ± 15			kV kV
f_C	Cut-off frequency $Z_{SOURCE} = 50\Omega, Z_{LOAD} = 50\Omega$			300		MHz
f_C	Roll-off frequency at -6dB Attenuation $Z_{SOURCE} = 50\Omega, Z_{LOAD} = 50\Omega$			380		MHz
R_{DYN}	Dynamic Resistance Positive Negative			2.3 0.9		Ω Ω

Note 1: $T_A = 25^\circ C$ unless otherwise specified.

Note 2: ESD applied to input and output pins with respect to GND, one at a time.

Note 3: Unused pins are left open.

Performance Information

Typical Filter Performance (nominal conditions unless specified otherwise, 50 Ohm Environment)

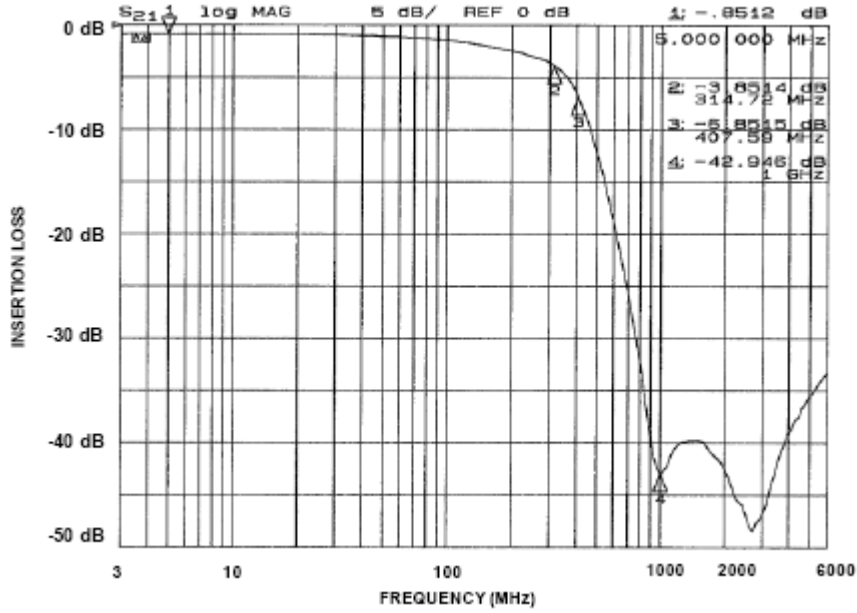

Figure 1. Insertion Loss VS. Frequency (CM1453-06: Filter 1)

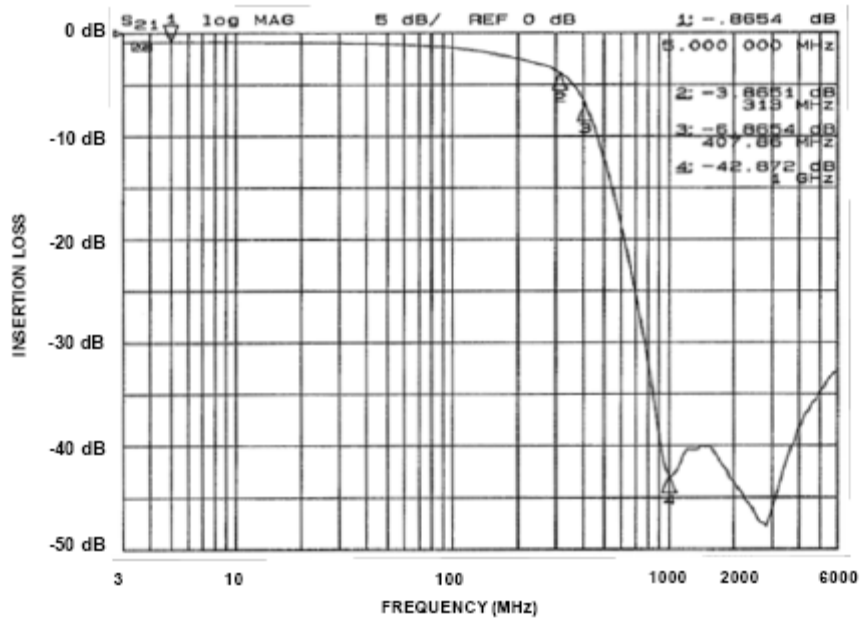

Figure 2. Insertion Loss VS. Frequency (CM1453-06: Filter 2)

Performance Information (cont'd)

Typical Filter Performance (nominal conditions unless specified otherwise, 50 Ohm Environment)

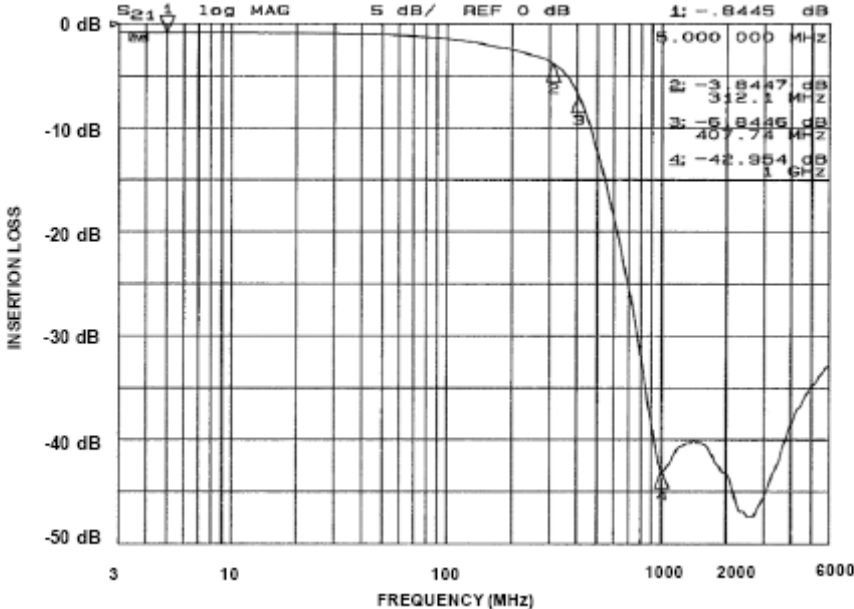

Figure 3. Insertion Loss VS. Frequency (CM1453-06: Filter 3)

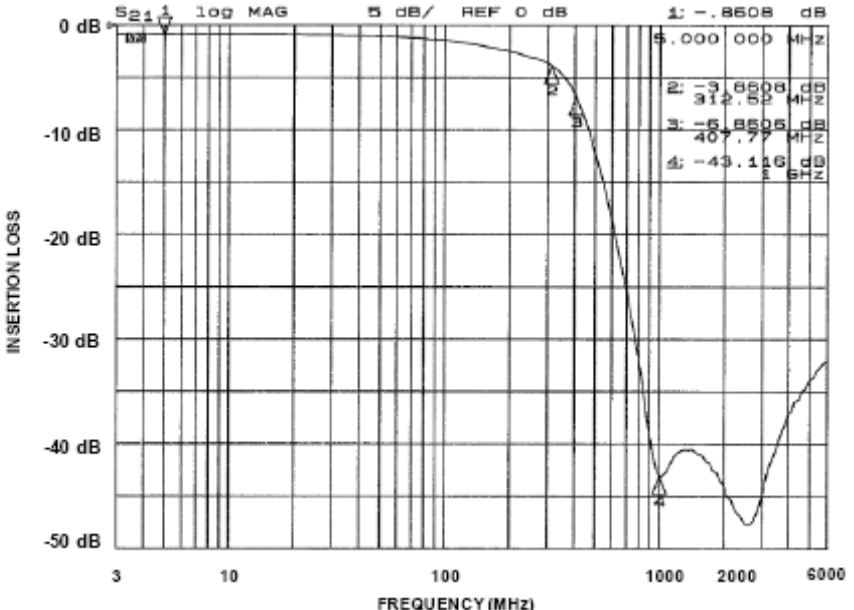

Figure 4. Insertion Loss VS. Frequency (CM1453-06: Filter 4)

Performance Information (cont'd)

Typical Filter Performance (nominal conditions unless specified otherwise, 50 Ohm Environment)

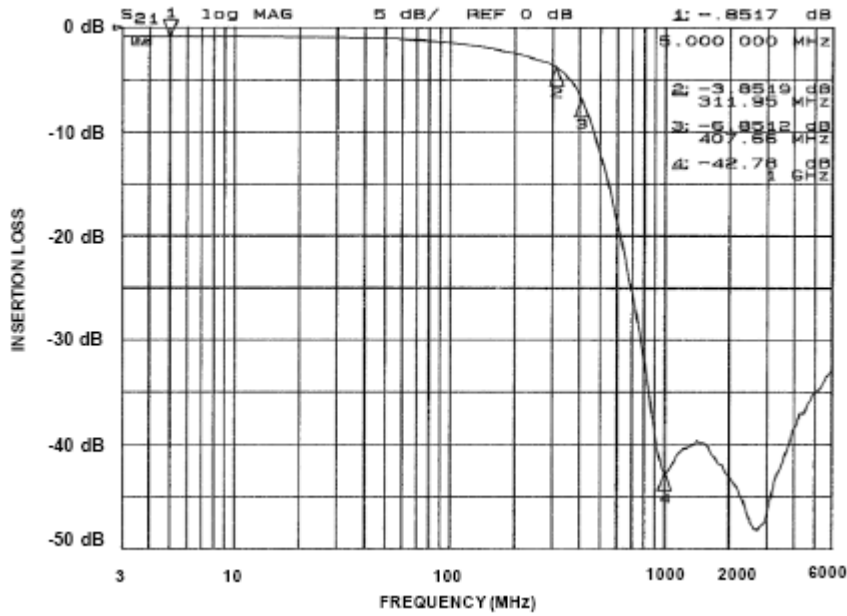

Figure 5. Insertion Loss VS. Frequency (CM1453-06: CSP1 – Filter 5)

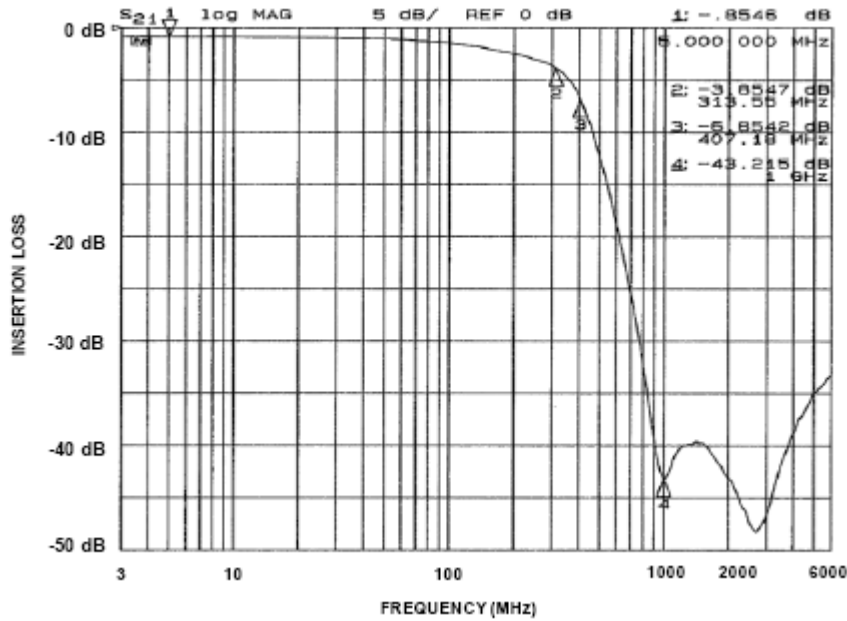

Figure 6. Insertion Loss VS. Frequency (CM1453-06: CSP1 – Filter 6)

Performance Information (cont'd)

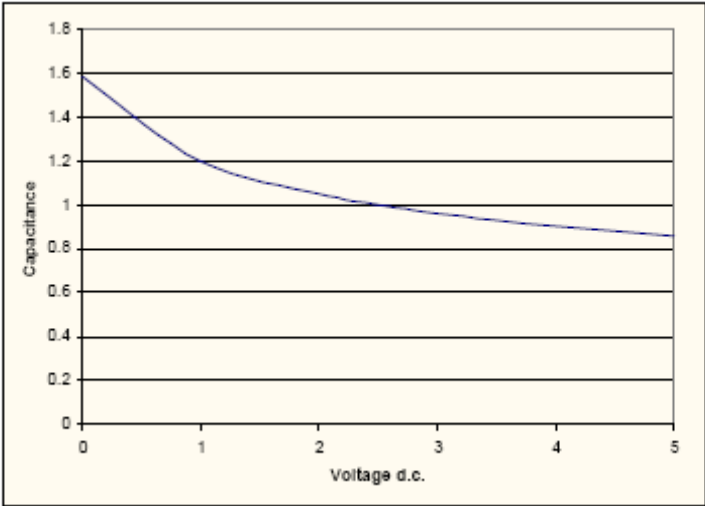

Figure 7. Typical Diode Capacitance vs. Input Voltage (normalized to 2.5V d.c)

Application Information

Refer to Application Note AP-217, "The Chip Scale Package", for a detailed description of Chip Scale Packages offered by California Micro Devices. See <http://www.wlcsforum.org/documents/pdf/ap-217.pdf> for download.

CM1453-06CP

Mechanical Specifications

CM1453 devices are packaged in custom Chip Scale Packages (CSP). See Application Note AP-217 for more information at: <http://www.wlcspforum.org/documents/pdf/ap-217.pdf>.

PACKAGE DIMENSIONS						
Package	Custom CSP					
Bumps	15					
Dim	Millimeters			Inches		
	Min	Nom	Max	Min	Nom	Max
A1	2.429	2.474	2.519	0.0956	0.0974	0.0992
A2	1.099	1.144	1.189	0.0433	0.0450	0.0468
B1	0.395	0.400	0.405	0.0156	0.0157	0.0159
B2	0.195	0.200	0.205	0.0077	0.0079	0.0081
B3	0.342	0.347	0.352	0.0135	0.0137	0.0139
B4	0.342	0.347	0.352	0.0135	0.0137	0.0139
C1	0.187	0.237	0.287	0.0074	0.0093	0.0113
C2	0.175	0.225	0.275	0.0069	0.0089	0.0108
D1	0.545	0.615	0.685	0.0215	0.0242	0.0270
D2	0.368	0.419	0.470	0.0145	0.0165	0.0185
# per tape and reel	3500 pieces					
Controlling dimension: millimeters						

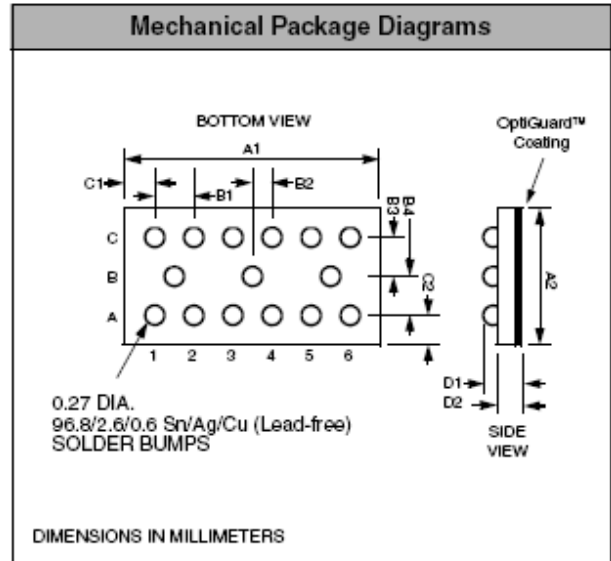

**Package Dimensions for
CM1453-06CP Chip Scale Package**

CSP Tape and Reel Specifications

PART NUMBER	CHIP SIZE (mm)	POCKET SIZE (mm) $B_0 \times A_0 \times K_0$	TAPE WIDTH W	REEL DIAMETER	QTY PER REEL	P_0	P_1
CM1453-06CP	2.47 X 1.14 X 0.615	2.59 X 1.27 X 0.73	8mm	178mm (7")	3500	4mm	4mm

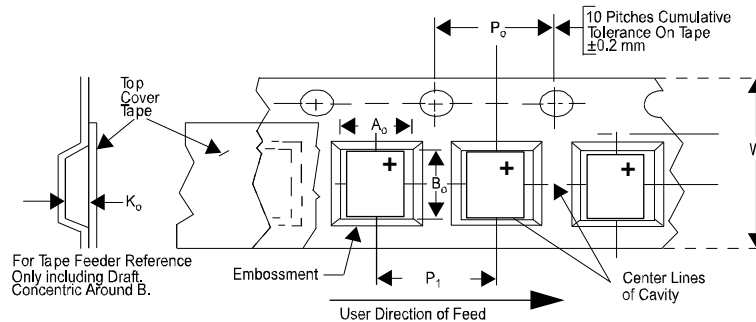

ON Semiconductor and  are registered trademarks of Semiconductor Components Industries, LLC (SCILLC). SCILLC reserves the right to make changes without further notice to any products herein. SCILLC makes no warranty, representation or guarantee regarding the suitability of its products for any particular purpose, nor does SCILLC assume any liability arising out of the application or use of any product or circuit, and specifically disclaims any and all liability, including without limitation special, consequential or incidental damages. "Typical" parameters which may be provided in SCILLC data sheets and/or specifications can and do vary in different applications and actual performance may vary over time. All operating parameters, including "Typicals" must be validated for each customer application by customer's technical experts. SCILLC does not convey any license under its patent rights nor the rights of others. SCILLC products are not designed, intended, or authorized for use as components in systems intended for surgical implant into the body, or other applications intended to support or sustain life, or for any other application in which the failure of the SCILLC product could create a situation where personal injury or death may occur. Should Buyer purchase or use SCILLC products for any such unintended or unauthorized application, Buyer shall indemnify and hold SCILLC and its officers, employees, subsidiaries, affiliates, and distributors harmless against all claims, costs, damages, and expenses, and reasonable attorney fees arising out of, directly or indirectly, any claim of personal injury or death associated with such unintended or unauthorized use, even if such claim alleges that SCILLC was negligent regarding the design or manufacture of the part. SCILLC is an Equal Opportunity/Affirmative Action Employer. This literature is subject to all applicable copyright laws and is not for resale in any manner.

PUBLICATION ORDERING INFORMATION

LITERATURE FULFILLMENT:
 Literature Distribution Center for ON Semiconductor
 P.O. Box 5163, Denver, Colorado 80217 USA
Phone: 303-675-2175 or 800-344-3860 Toll Free USA/Canada
Fax: 303-675-2176 or 800-344-3867 Toll Free USA/Canada
Email: orderlit@onsemi.com

N. American Technical Support: 800-282-9855
 Toll Free USA/Canada
Europe, Middle East and Africa Technical Support:
 Phone: 421 33 790 2910
Japan Customer Focus Center
 Phone: 81-3-5773-3850

ON Semiconductor Website: www.onsemi.com
 Order Literature: <http://www.onsemi.com/orderlit>
 For additional information, please contact your local Sales Representative