



Chipsmall Limited consists of a professional team with an average of over 10 year of expertise in the distribution of electronic components. Based in Hongkong, we have already established firm and mutual-benefit business relationships with customers from,Europe,America and south Asia,supplying obsolete and hard-to-find components to meet their specific needs.

With the principle of “Quality Parts,Customers Priority,Honest Operation,and Considerate Service”,our business mainly focus on the distribution of electronic components. Line cards we deal with include Microchip,ALPS,ROHM,Xilinx,Pulse,ON,Everlight and Freescale. Main products comprise IC,Modules,Potentiometer,IC Socket,Relay,Connector.Our parts cover such applications as commercial,industrial, and automotives areas.

We are looking forward to setting up business relationship with you and hope to provide you with the best service and solution. Let us make a better world for our industry!



Contact us

Tel: +86-755-8981 8866 Fax: +86-755-8427 6832

Email & Skype: info@chipsmall.com Web: www.chipsmall.com

Address: A1208, Overseas Decoration Building, #122 Zhenhua RD., Futian, Shenzhen, China



MITSUBISHI IGBT MODULES
CM400DU-24NFH

HIGH POWER SWITCHING USE

CM400DU-24NFH



- IC 400A
- VCES 1200V
- Insulated Type
- 2-elements in a pack

APPLICATION

High frequency switching use (30kHz to 60kHz).
 Gradient amplifier, Induction heating, power supply, etc.

OUTLINE DRAWING & CIRCUIT DIAGRAM

Dimensions in mm

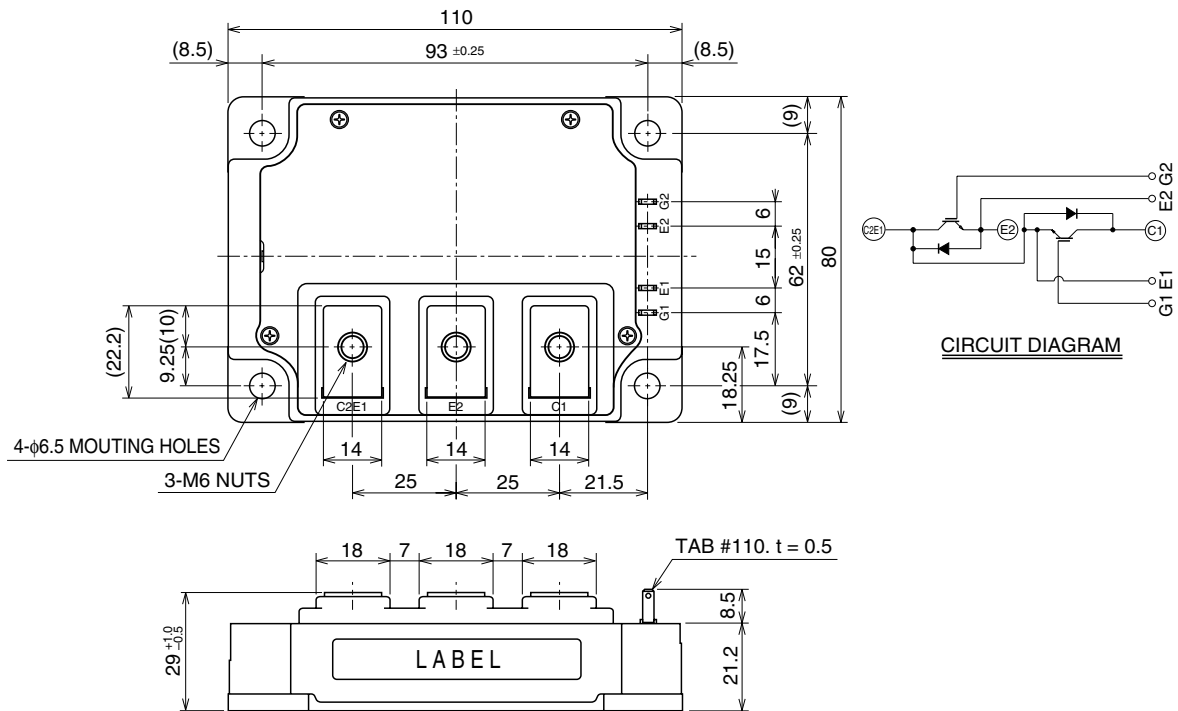

CM400DU-24NFH

HIGH POWER SWITCHING USE

MAXIMUM RATINGS (Tj = 25°C, unless otherwise specified)

Symbol	Parameter	Conditions	Ratings	Unit
VCES	Collector-emitter voltage	G-E Short	1200	V
VGES	Gate-emitter voltage	C-E Short	±20	V
IC	Collector current	Operation (Note 2)	400	A
ICM		Pulse (Note 2)	800	A
IE (Note 1)	Emitter current	Operation (Note 2)	400	A
IEM (Note 1)		Pulse (Note 2)	800	A
PC (Note 3)	Maximum collector dissipation	Tc = 25°C	1040	W
PC' (Note 3)	Maximum collector dissipation	Tc' = 25°C ⁴	2450	W
Tj	Junction temperature		-40 ~ +150	°C
Tstg	Storage temperature		-40 ~ +125	°C
Viso	Isolation voltage	Terminals to base plate, f = 60Hz, AC 1 minute	2500	Vrms
—	Mounting torque	Main terminals M6 screw	3.5 ~ 4.5	N • m
—		Mounting M6 screw	3.5 ~ 4.5	N • m
—	Weight	Typical value	580	g

ELECTRICAL CHARACTERISTICS (Tj = 25°C, unless otherwise specified)

Symbol	Parameter	Test conditions	Limits			Unit	
			Min.	Typ.	Max.		
ICES	Collector cutoff current	VCE = VCES, VGE = 0V	—	—	1	mA	
VGE(th)	Gate-emitter threshold voltage	IC = 40mA, VCE = 10V	4.5	6	7.5	V	
IGES	Gate leakage current	±VGE = VGES, VCE = 0V	—	—	1.4	µA	
VCE(sat)	Collector-emitter saturation voltage	IC = 400A, VGE = 15V				V	
		Tj = 25°C	—	5.0	6.5		
		Tj = 125°C	—	5.0	—		
Cies	Input capacitance	VCE = 10V VGE = 0V	—	—	63	nF	
Coes	Output capacitance		—	—	5.3	nF	
Cres	Reverse transfer capacitance		—	—	1.2	nF	
QG	Total gate charge	VCC = 600V, IC = 400A, VGE = 15V	—	1800	—	nC	
td(on)	Turn-on delay time	VCC = 600V, IC = 400A VGE = ±15V RG = 0.78Ω, Inductive load	—	—	300	ns	
tr	Turn-on rise time		—	—	100	ns	
td(off)	Turn-off delay time		—	—	500	ns	
tf	Turn-off fall time		—	—	150	ns	
trr (Note 1)	Reverse recovery time		IE = 400A	—	—	250	ns
Qrr (Note 1)	Reverse recovery charge			—	16	—	µC
VEC(Note 1)	Emitter-collector voltage	IE = 400A, VGE = 0V	—	—	3.5	V	
Rth(j-c)Q	Thermal resistance*1	IGBT part (1/2 module)	—	—	0.12	K/W	
Rth(j-c)R		FWDi part (1/2 module)	—	—	0.23	K/W	
Rth(c-f)	Contact thermal resistance	Case to heat sink, Thermal compound Applied ² (1/2 module)	—	0.02	—	K/W	
Rth(j-c)Q	Thermal resistance*4	IGBT part (1/2 module)	—	—	0.051 ³	K/W	
Rth(j-c)R		FWDi part (1/2 module)	—	—	0.093 ³	K/W	
RG	External gate resistance		0.78	—	7.8	Ω	

*1 : Case temperature (Tc) measured point is shown in page OUTLINE DRAWING.

*2 : Typical value is measured by using thermally conductive grease of λ = 0.9[W/(m • K)].

*3 : If you use this value, Rth(f-a) should be measured just under the chips.

*4 : Case temperature (Tc) measured point is just under the chips.

Note 1. IE, VEC, trr & Qrr represent characteristics of the anti-parallel, emitter-collector free-wheel diode (FWDi).

2. Pulse width and repetition rate should be such that the device junction temperature (Tj) does not exceed Tjmax rating.

3. Junction temperature (Tj) should not increase beyond 150°C.

4. No short circuit capability is designed.

CM400DU-24NFH

HIGH POWER SWITCHING USE

PERFORMANCE CURVES

OUTPUT CHARACTERISTICS (TYPICAL)

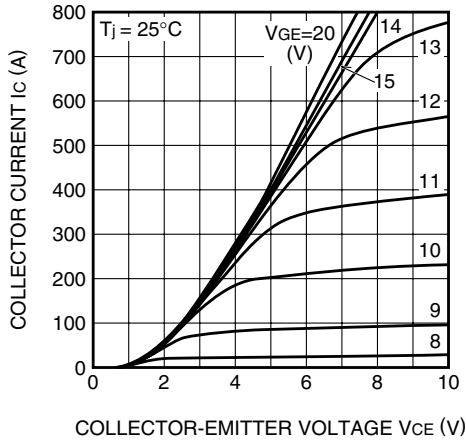

TRANSFER CHARACTERISTICS (TYPICAL)

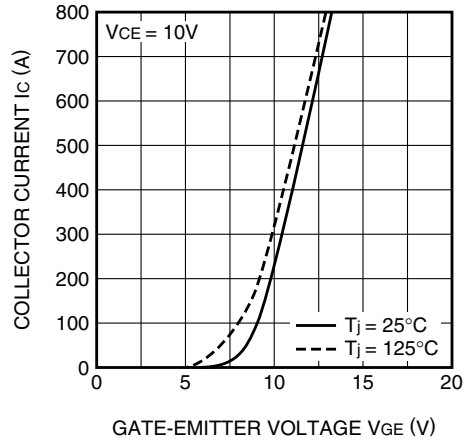

COLLECTOR-EMITTER SATURATION VOLTAGE CHARACTERISTICS (TYPICAL)

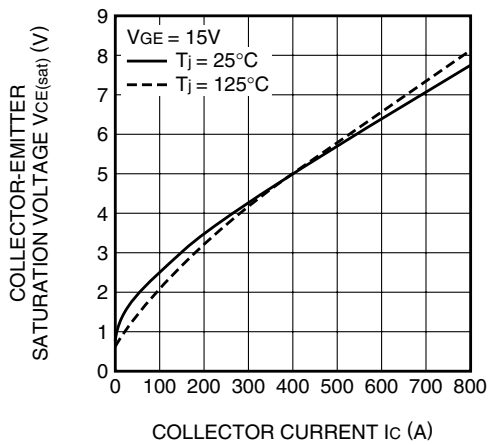

COLLECTOR-EMITTER SATURATION VOLTAGE CHARACTERISTICS (TYPICAL)

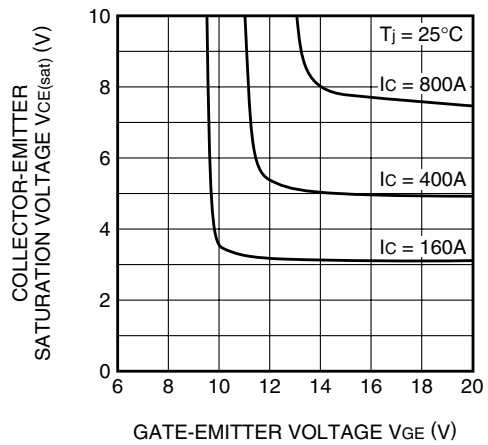

FREE-WHEEL DIODE FORWARD CHARACTERISTICS (TYPICAL)

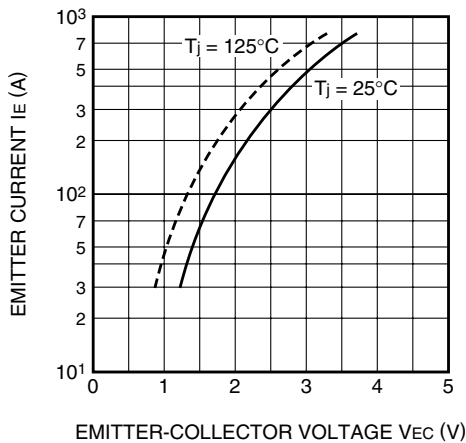

CAPACITANCE CHARACTERISTICS (TYPICAL)

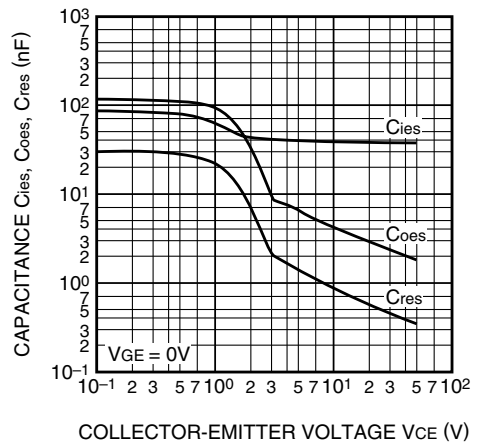

CM400DU-24NFH

HIGH POWER SWITCHING USE

HALF-BRIDGE SWITCHING TIME CHARACTERISTICS (TYPICAL)

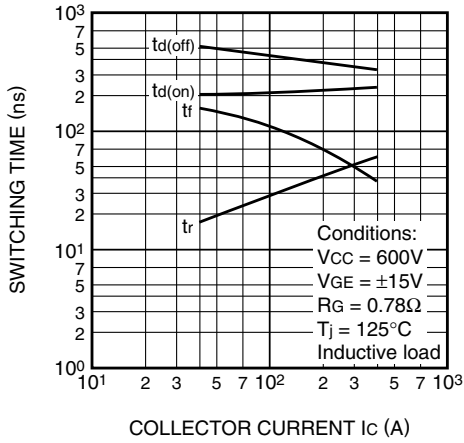

REVERSE RECOVERY CHARACTERISTICS OF FREE-WHEEL DIODE (TYPICAL)

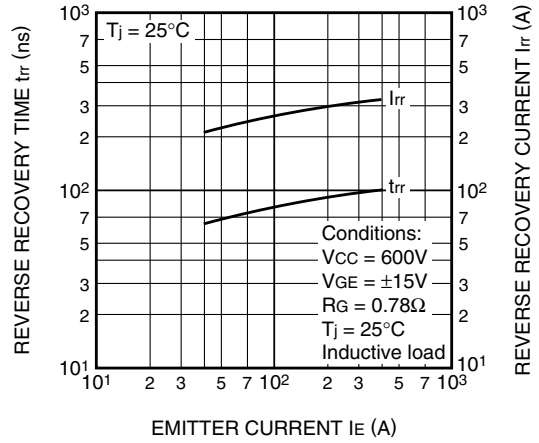

TRANSIENT THERMAL IMPEDANCE CHARACTERISTICS (IGBT part)

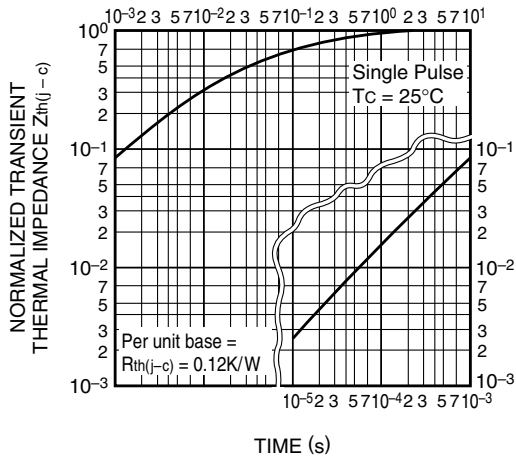

TRANSIENT THERMAL IMPEDANCE CHARACTERISTICS (FWDi part)

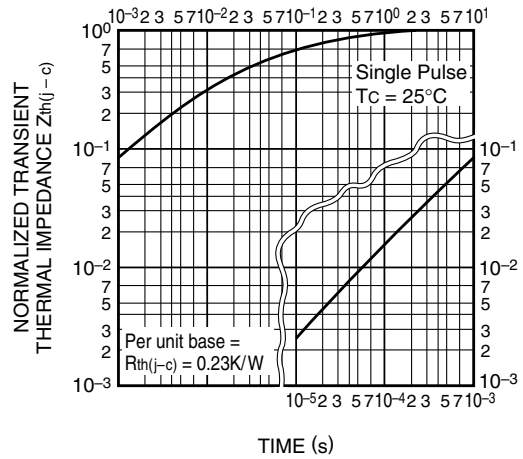

GATE CHARGE CHARACTERISTICS (TYPICAL)

