



Chipsmall Limited consists of a professional team with an average of over 10 year of expertise in the distribution of electronic components. Based in Hongkong, we have already established firm and mutual-benefit business relationships with customers from,Europe,America and south Asia,supplying obsolete and hard-to-find components to meet their specific needs.

With the principle of “Quality Parts,Customers Priority,Honest Operation,and Considerate Service”,our business mainly focus on the distribution of electronic components. Line cards we deal with include Microchip,ALPS,ROHM,Xilinx,Pulse,ON,Everlight and Freescale. Main products comprise IC,Modules,Potentiometer,IC Socket,Relay,Connector.Our parts cover such applications as commercial,industrial, and automotives areas.

We are looking forward to setting up business relationship with you and hope to provide you with the best service and solution. Let us make a better world for our industry!



## Contact us

Tel: +86-755-8981 8866 Fax: +86-755-8427 6832

Email & Skype: info@chipsmall.com Web: www.chipsmall.com

Address: A1208, Overseas Decoration Building, #122 Zhenhua RD., Futian, Shenzhen, China



MITSUBISHI IGBT MODULES  
**CM400DY-24NF**

HIGH POWER SWITCHING USE

**CM400DY-24NF**



- IC ..... 400A
- VCES ..... 1200V
- Insulated Type
- 2-elements in a pack

**APPLICATION**

General purpose inverters & Servo controls, etc

**OUTLINE DRAWING & CIRCUIT DIAGRAM**

Dimensions in mm

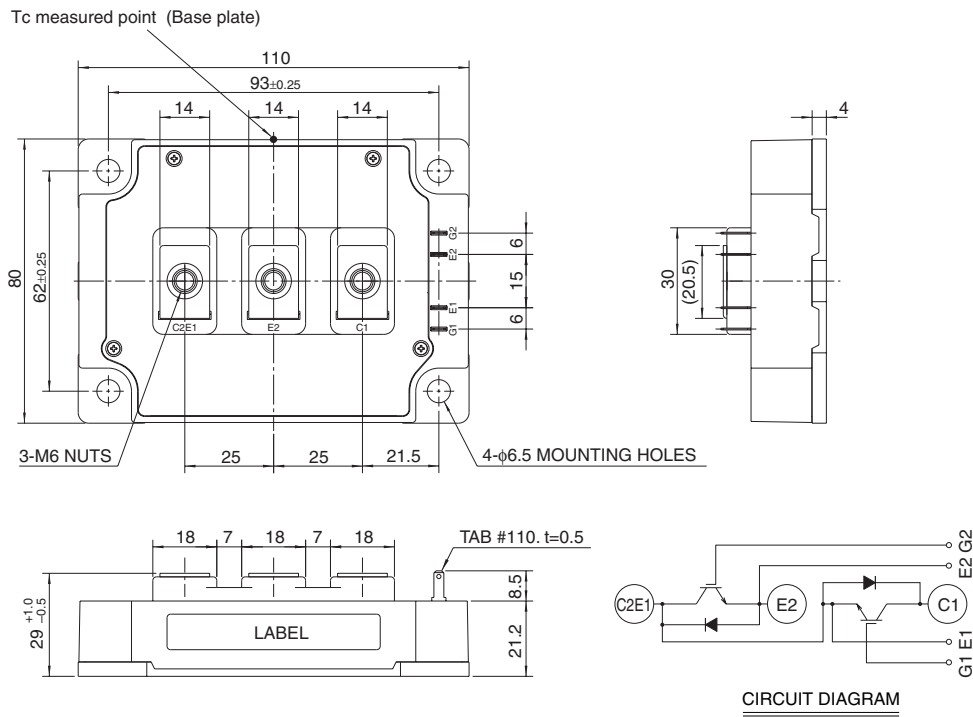

**CM400DY-24NF**

**HIGH POWER SWITCHING USE**

**MAXIMUM RATINGS** (T<sub>j</sub> = 25°C, unless otherwise specified)

Symbol	Parameter	Conditions	Ratings	Unit
V <sub>CE</sub> S	Collector-emitter voltage	G-E Short	1200	V
V <sub>GE</sub> S	Gate-emitter voltage	C-E Short	±20	V
I <sub>C</sub>	Collector current	DC, T <sub>c</sub> ' = 111°C <sup>*3</sup>	400	A
I <sub>CM</sub>		Pulse (Note 2)	800	A
I <sub>E</sub> (Note 1)	Emitter current		400	A
I <sub>EM</sub> (Note 1)		Pulse (Note 2)	800	A
P <sub>C</sub> (Note 3)	Maximum collector dissipation	T <sub>c</sub> = 25°C	1470	W
T <sub>j</sub>	Junction temperature		-40 ~ +150	°C
T <sub>stg</sub>	Storage temperature		-40 ~ +125	°C
V <sub>iso</sub>	Isolation voltage	Terminals to base plate, f = 60Hz, AC 1 minute	2500	V <sub>rms</sub>
—	Torque strength	Main terminals M6 screw	3.5 ~ 4.5	N • m
—		Mounting M6 screw	3.5 ~ 4.5	N • m
—	Weight	Typical value	580	g

**ELECTRICAL CHARACTERISTICS** (T<sub>j</sub> = 25°C, unless otherwise specified)

Symbol	Parameter	Test conditions	Limits			Unit	
			Min.	Typ.	Max.		
I <sub>CES</sub>	Collector cutoff current	V <sub>CE</sub> = V <sub>CE</sub> S, V <sub>GE</sub> = 0V	—	—	1	mA	
V <sub>GE(th)</sub>	Gate-emitter threshold voltage	I <sub>C</sub> = 40mA, V <sub>CE</sub> = 10V	6	7	8	V	
I <sub>GES</sub>	Gate leakage current	±V <sub>GE</sub> = V <sub>GE</sub> S, V <sub>CE</sub> = 0V	—	—	0.5	μA	
V <sub>CE(sat)</sub>	Collector-emitter saturation voltage	I <sub>C</sub> = 400A, V <sub>GE</sub> = 15V	T <sub>j</sub> = 25°C	—	1.8	2.5	V
			T <sub>j</sub> = 125°C	—	2.0	—	
C <sub>ies</sub>	Input capacitance	V <sub>CE</sub> = 10V V <sub>GE</sub> = 0V	—	—	94	nF	
C <sub>oes</sub>	Output capacitance		—	—	8	nF	
C <sub>res</sub>	Reverse transfer capacitance		—	—	1.8	nF	
Q <sub>G</sub>	Total gate charge	V <sub>CC</sub> = 600V, I <sub>C</sub> = 400A, V <sub>GE</sub> = 15V	—	2700	—	nC	
t <sub>d(on)</sub>	Turn-on delay time	V <sub>CC</sub> = 600V, I <sub>C</sub> = 400A V <sub>GE</sub> = ±15V R <sub>G</sub> = 0.78Ω, Inductive load I <sub>E</sub> = 400A	—	—	600	ns	
t <sub>r</sub>	Turn-on rise time		—	—	160	ns	
t <sub>d(off)</sub>	Turn-off delay time		—	—	700	ns	
t <sub>f</sub>	Turn-off fall time		—	—	350	ns	
t <sub>rr</sub> (Note 1)	Reverse recovery time		—	—	250	ns	
Q <sub>rr</sub> (Note 1)	Reverse recovery charge	—	16	—	μC		
V <sub>EC</sub> (Note 1)	Emitter-collector voltage	I <sub>E</sub> = 400A, V <sub>GE</sub> = 0V	—	—	3.2	V	
R <sub>th(j-c)Q</sub>	Thermal resistance <sup>*1</sup>	IGBT part (1/2 module)	—	—	0.085	K/W	
R <sub>th(j-c)R</sub>		FWDi part (1/2 module)	—	—	0.15	K/W	
R <sub>th(c-f)</sub>	Contact thermal resistance	Case to heat sink, Thermal compound Applied <sup>*2</sup> (1/2 module)	—	0.02	—	K/W	
R <sub>th(j-c')Q</sub>	Thermal resistance	Case temperature measured point is just under the chips	—	—	0.034 <sup>*3</sup>	K/W	
R <sub>G</sub>	External gate resistance		0.78	—	7.8	Ω	

\*1 : Case temperature (T<sub>c</sub>) measured point is shown in page OUTLINE DRAWING.

\*2 : Typical value is measured by using thermally conductive grease of λ = 0.9[W/(m • K)].

\*3 : Case temperature (T<sub>c</sub>) measured point is just under the chips.

If you use this value, R<sub>th(f-a)</sub> should be measured just under the chips.

Note 1. I<sub>E</sub>, I<sub>EM</sub>, V<sub>EC</sub>, t<sub>rr</sub> & Q<sub>rr</sub> represent characteristics of the anti-parallel, emitter-collector free-wheel diode (FWDi).

2. Pulse width and repetition rate should be such that the device junction temperature (T<sub>j</sub>) does not exceed T<sub>jmax</sub> rating.

3. Junction temperature (T<sub>j</sub>) should not increase beyond 150°C.

# CM400DY-24NF

HIGH POWER SWITCHING USE

PERFORMANCE CURVES

**OUTPUT CHARACTERISTICS (TYPICAL)**

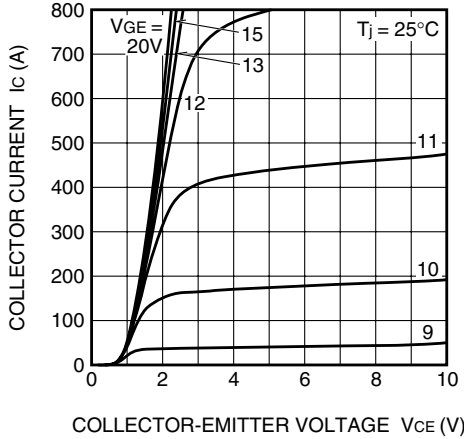

**COLLECTOR-EMITTER SATURATION VOLTAGE CHARACTERISTICS (TYPICAL)**

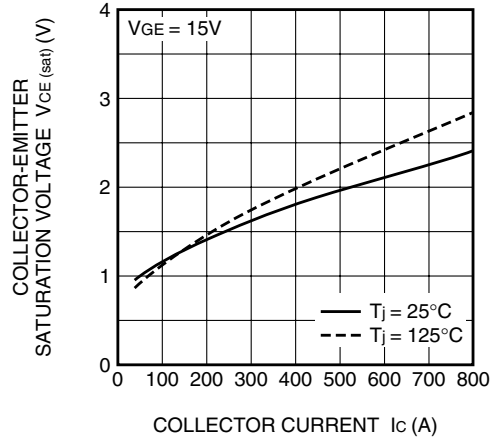

**COLLECTOR-EMITTER SATURATION VOLTAGE CHARACTERISTICS (TYPICAL)**

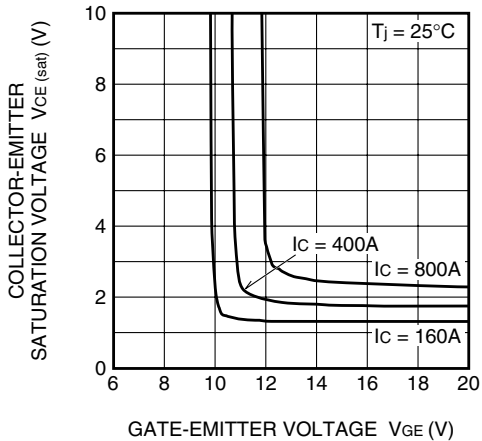

**FREE-WHEEL DIODE FORWARD CHARACTERISTICS (TYPICAL)**

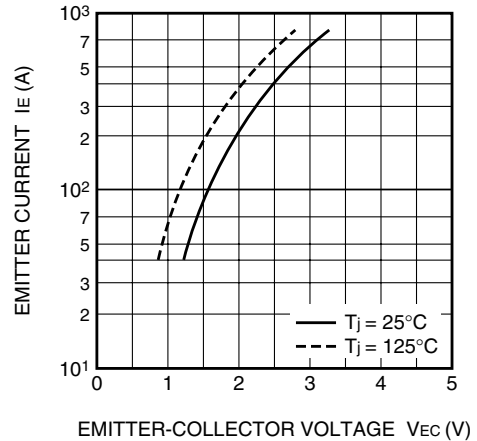

**CAPACITANCE-VCE CHARACTERISTICS (TYPICAL)**

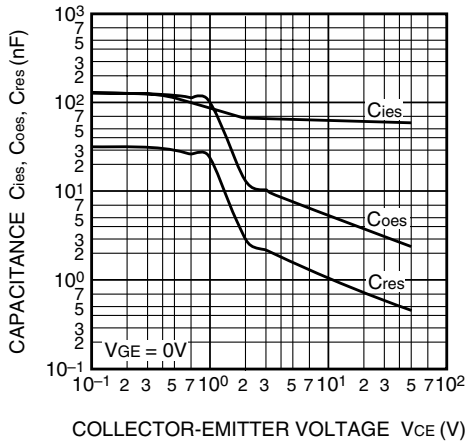

**HALF-BRIDGE SWITCHING CHARACTERISTICS (TYPICAL)**

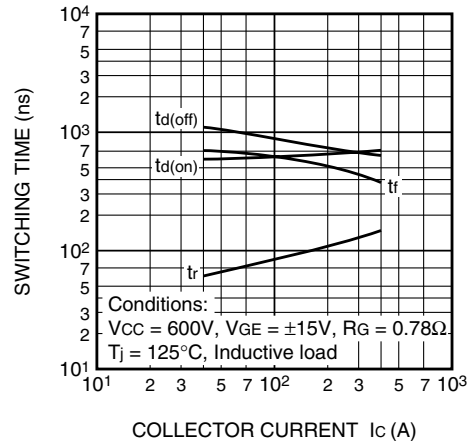

REVERSE RECOVERY CHARACTERISTICS OF FREE-WHEEL DIODE (TYPICAL)

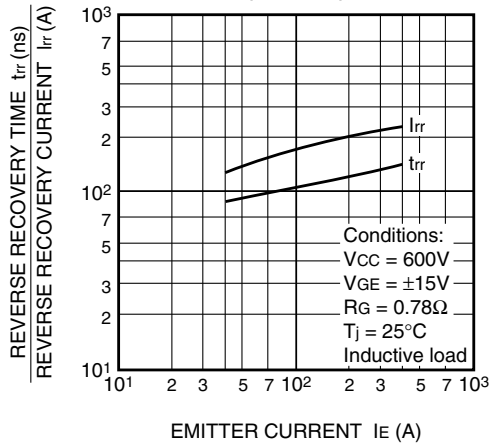

TRANSIENT THERMAL IMPEDANCE CHARACTERISTICS (IGBT part & FWDi part)

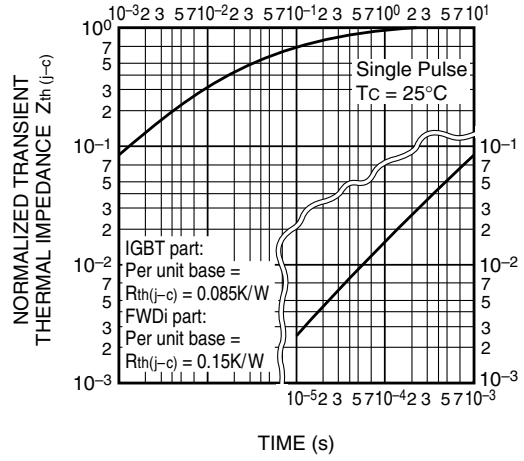

GATE CHARGE CHARACTERISTICS (TYPICAL)

