



Chipsmall Limited consists of a professional team with an average of over 10 year of expertise in the distribution of electronic components. Based in Hongkong, we have already established firm and mutual-benefit business relationships with customers from,Europe,America and south Asia,supplying obsolete and hard-to-find components to meet their specific needs.

With the principle of “Quality Parts,Customers Priority,Honest Operation,and Considerate Service”,our business mainly focus on the distribution of electronic components. Line cards we deal with include Microchip,ALPS,ROHM,Xilinx,Pulse,ON,Everlight and Freescale. Main products comprise IC,Modules,Potentiometer,IC Socket,Relay,Connector.Our parts cover such applications as commercial,industrial, and automotives areas.

We are looking forward to setting up business relationship with you and hope to provide you with the best service and solution. Let us make a better world for our industry!



Contact us

Tel: +86-755-8981 8866 Fax: +86-755-8427 6832

Email & Skype: info@chipsmall.com Web: www.chipsmall.com

Address: A1208, Overseas Decoration Building, #122 Zhenhua RD., Futian, Shenzhen, China



CM5441Z161B-00

STEWARD PART NUMBERING SYSTEM

CM	2545	X	111	B	-	00
PRODUCT SERIES CODE	PART SIZE CODE	RATED CURRENT CODE	IMPEDANCE VALUE CODE	PACKAGING CODE	-	ADDITIONAL DESCRIPTION

Ambient Operating Temperature Range : -55°C to + 125°C

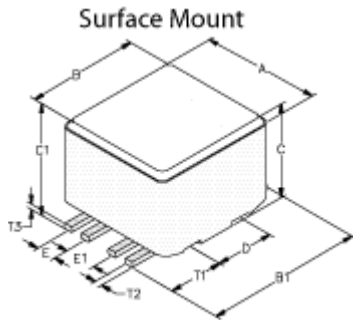
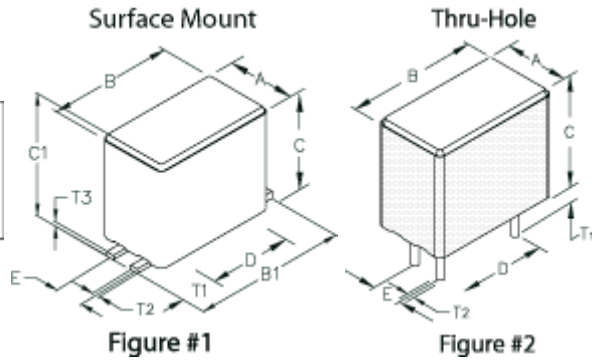

Figure #3

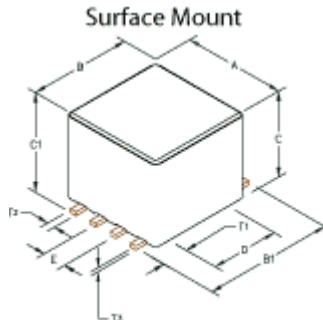

Figure #4

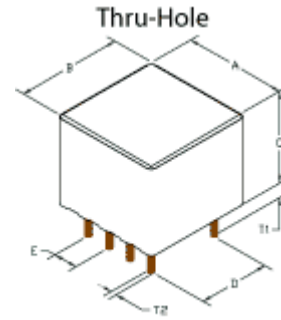

Figure #5

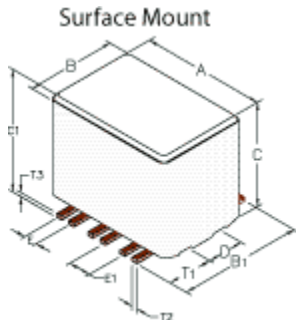

Figure #6

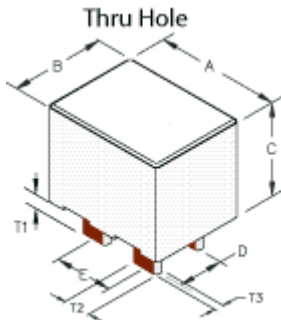

Figure #7

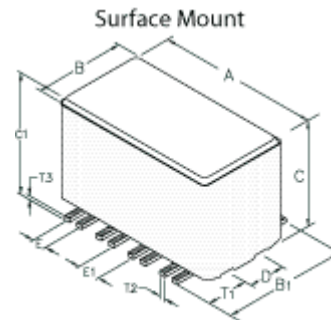

Figure #8

Drawing Figure

Figure Number
7

Electrical Characteristics

NET Z @ 100 MHz	DCR Max	Rated Current mA
160	0.0003	75000

Physical Dimensions

A	B	B1	C	C1	D	E	E1	A	B	B1	C	C1	D	E	E1
mm	mm	mm	mm	mm	mm	mm	mm	in	in	in	in	in	in	in	in
13.72	10.41	-	15.24	-	5.28	6.35	-	0.540	0.410	-	0.600	-	0.208	0.250	-

Wire Dimensions

--

T1 mm	T2 mm	T3 mm	T1 in	T2 in	T3 in
3.05	3.07	0.97	0.120	0.121	0.038

CM5441Z161B-00

Z vs. Frequency (C,O,N)

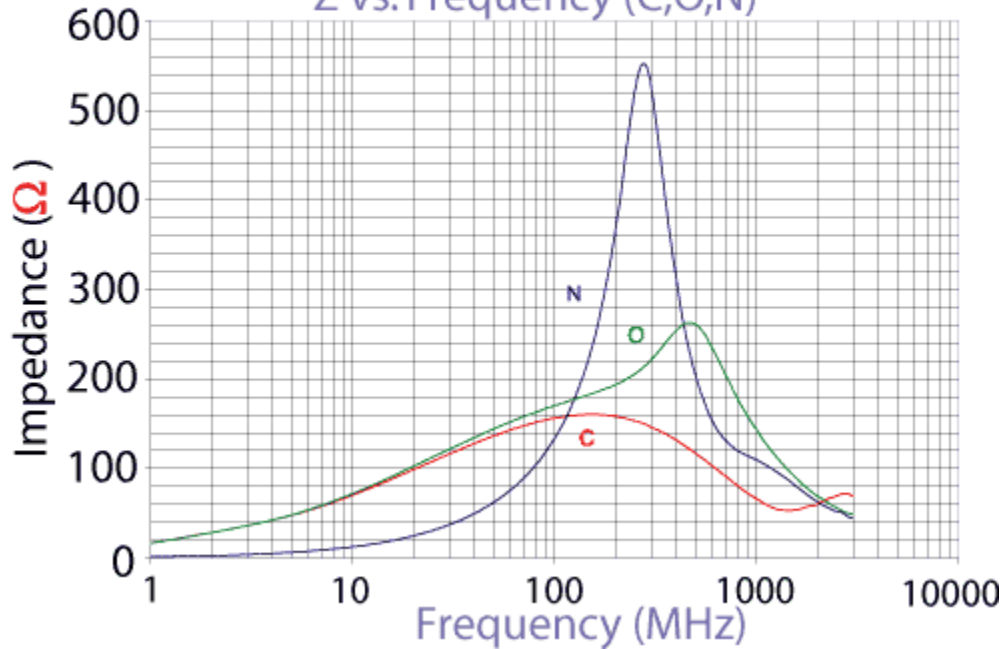

CM5441Z161B-00

Z, R, X_L vs Frequency

