



Chipsmall Limited consists of a professional team with an average of over 10 year of expertise in the distribution of electronic components. Based in Hongkong, we have already established firm and mutual-benefit business relationships with customers from,Europe,America and south Asia,supplying obsolete and hard-to-find components to meet their specific needs.

With the principle of “Quality Parts,Customers Priority,Honest Operation,and Considerate Service”,our business mainly focus on the distribution of electronic components. Line cards we deal with include Microchip,ALPS,ROHM,Xilinx,Pulse,ON,Everlight and Freescale. Main products comprise IC,Modules,Potentiometer,IC Socket,Relay,Connector.Our parts cover such applications as commercial,industrial, and automotives areas.

We are looking forward to setting up business relationship with you and hope to provide you with the best service and solution. Let us make a better world for our industry!



Contact us

Tel: +86-755-8981 8866 Fax: +86-755-8427 6832

Email & Skype: info@chipsmall.com Web: www.chipsmall.com

Address: A1208, Overseas Decoration Building, #122 Zhenhua RD., Futian, Shenzhen, China



Steward

Advanced Ferrite Materials, EMI Suppression, and Inductive Products

Home • Ferrite Product Lines • New Products • Technical • General • Contact • Steward Sales

CM5740Z171R-00

STEWARD PART NUMBERING SYSTEM					
CM	2545	X	111	B	- 00
PRODUCT SERIES CODE	PART SIZE CODE	RATED CURRENT CODE	IMPEDANCE VALUE CODE	PACKAGING CODE	ADDITIONAL DESCRIPTION

Ambient Operating Temperature Range: -55°C to +125°C

Surface Mount

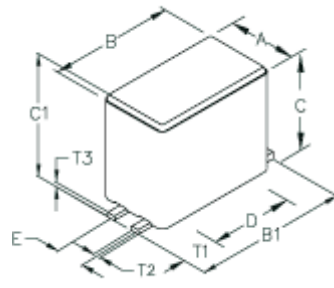

Figure #1

Thru-Hole

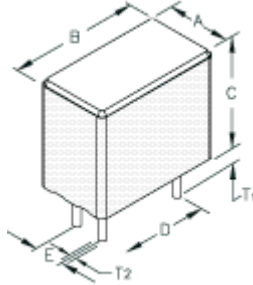

Figure #2

Surface Mount

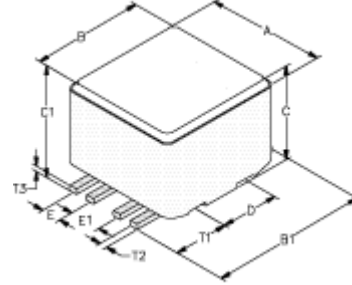

Figure #3

Surface Mount

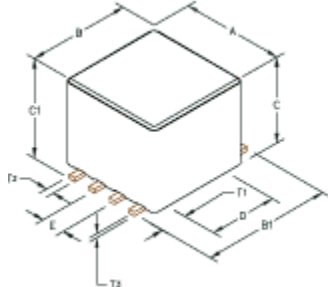

Figure #4

Thru-Hole

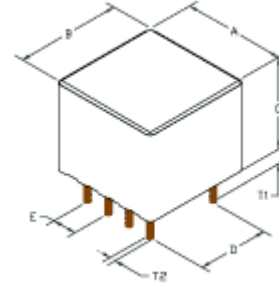
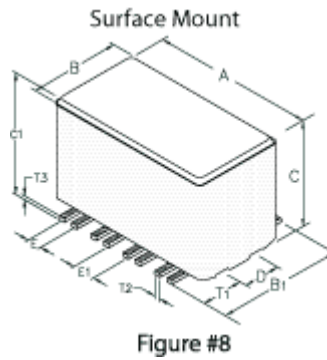
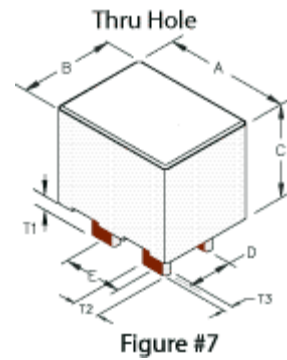
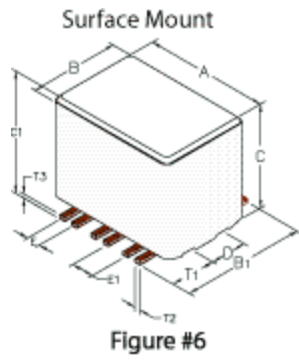

Figure #5



Drawing Figure #

Figure Number
4

Electrical Characteristics

NET Z @ 100 MHz	DCR Max	Rated Current mA
170	0.001	20000

Physical Dimensions

A	B	B1	C	C1	D	E	E1	A	B	B1	C	C1	D	E	E1
mm	mm	mm	mm	mm	mm	mm	mm	in	in	in	in	in	in	in	in
14.48	10.03	11.05	9.32	10.49	4.06	2.54	3.43	0.570	0.395	0.435	0.367	0.413	0.160	0.100	0.135

Wire Dimensions

T1 mm	T2 mm	T3 mm	T1 in	T2 in	T3 in
3.56	0.76	0.76	0.140	0.030	0.030

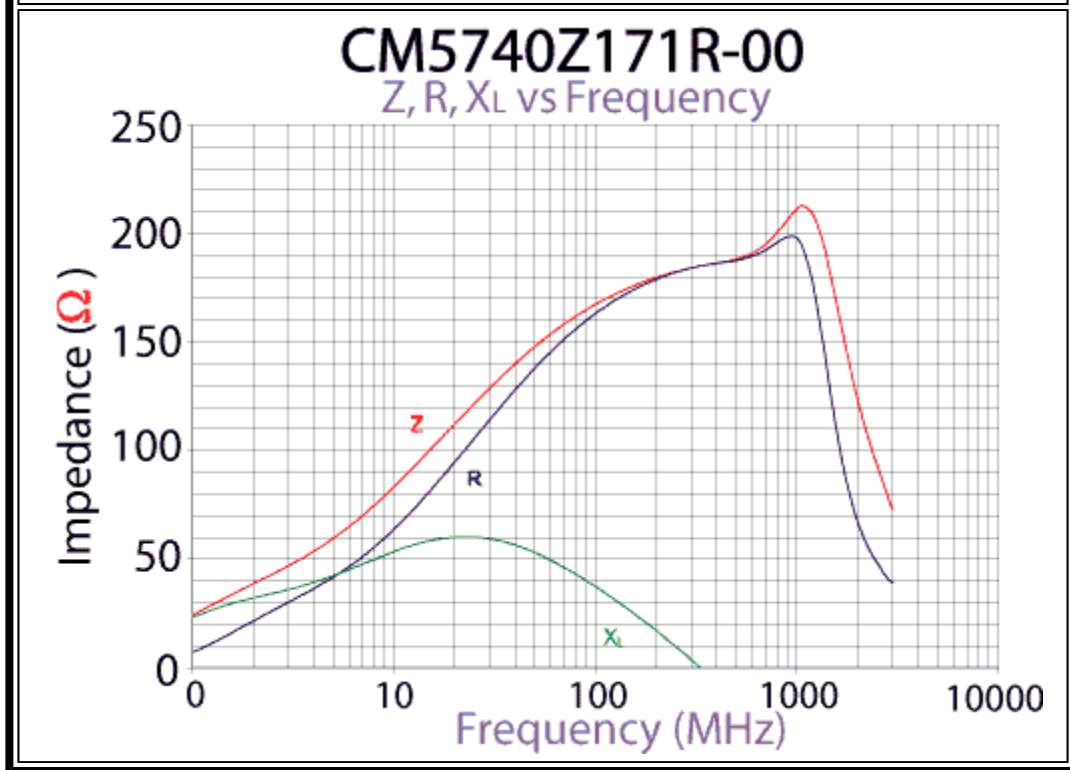
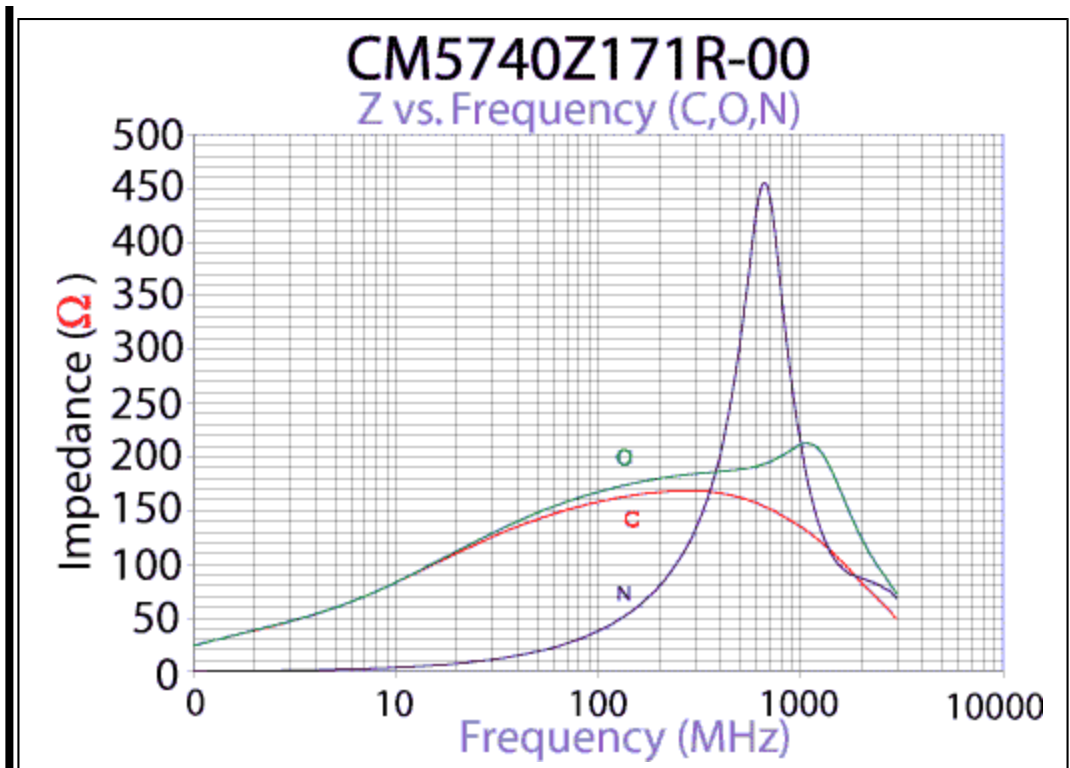

Specifications, which provide more details for the correct use of the described products, are available upon request. All specifications are subject to change without notice. For more information on any of the products listed above, please contact Steward customer service department at (800) 634-2673.

americas@steward.com mexico@steward.com europa@steward.com asia@steward.com

Copyright© 2004 Steward, Inc.

Last Updated: 2/24/2004