



Chipsmall Limited consists of a professional team with an average of over 10 year of expertise in the distribution of electronic components. Based in Hongkong, we have already established firm and mutual-benefit business relationships with customers from,Europe,America and south Asia,supplying obsolete and hard-to-find components to meet their specific needs.

With the principle of “Quality Parts,Customers Priority,Honest Operation,and Considerate Service”,our business mainly focus on the distribution of electronic components. Line cards we deal with include Microchip,ALPS,ROHM,Xilinx,Pulse,ON,Everlight and Freescale. Main products comprise IC,Modules,Potentiometer,IC Socket,Relay,Connector.Our parts cover such applications as commercial,industrial, and automotives areas.

We are looking forward to setting up business relationship with you and hope to provide you with the best service and solution. Let us make a better world for our industry!



Contact us

Tel: +86-755-8981 8866 Fax: +86-755-8427 6832

Email & Skype: info@chipsmall.com Web: www.chipsmall.com

Address: A1208, Overseas Decoration Building, #122 Zhenhua RD., Futian, Shenzhen, China



DETAILS

Product Number	CN13918_MIRELLA-50-S-PF-VERO13
Family	Mirella
Type	RefPack
Color	metal
Diameter	49,9 mm
Height	24 mm
Style	round
Optic Material	
Holder Material	
Fastening	
Status	production ready
ROHS Compliant	Yes
Date Updated	6/03/2017



OPTICAL PROPERTIES

LED	Viewing Angle	Light Beam	Efficiency	cd/lm	Connector
VERO13	25 deg	Spot	89 %	2.540	-
Xenio Point 13mm	26 deg	Spot	87 %	2.400	LEDiL: LEDiL
V10 Gen7	21 deg	Spot	91 %	3.400	Bender Wirth: 434 Typ L1
CLU720/721	23 deg	Spot	82 %	2.600	Bender Wirth: 433 Typ L1
CLU700/701	19 deg	Spot	84 %	4.000	Bender Wirth: 434 Typ L1
CLL02x/CLU02x (LES10)	21 deg	Spot	84 %	3.100	Bender Wirth: 434 Typ L1
CXA/B 15xx	20 deg	Spot	84 %	3.300	Bender Wirth: 441 Typ L1
LUXEON CoB 1202/1203	20 deg	Spot	84 %	3.200	Bender Wirth: 438 Typ L1
CXM-14	sim: 29	Spot	sim: 76 %	sim: 1.800	-
CXM-9	sim: 21	Spot	sim: 84 %	sim: 3.100	Bender Wirth: 434 Typ L1
COB L-Type (LES 9)	19 deg	Spot	85 %	3.400	Bender Wirth: 438 Typ L1
COB S-Type	sim: 19	Spot	sim: 87 %	sim: 3.900	Bender Wirth: 452 Typ L1
COB L-Type (LES 11)	24 deg	Spot	81 %	2.500	Bender Wirth: 438 Typ L1
Solerialq P9	19 deg	Spot	86 %	3.400	Bender Wirth: 461 Typ L1
Solerialq P6	17 deg	Spot	89 %	4.600	Bender Wirth: 446 Typ L1
Solerialq S9	sim: 19	Spot	sim: 87 %	sim: 3.700	Bender Wirth: 434 Typ L1
Solerialq S15	sim: 28	Spot	sim: 85 %	sim: 1.990	Bender Wirth: 433 Typ L1
LC010C	sim: 16	Spot	sim: 87 %	sim: 4.800	Bender Wirth: 479 Typ L1
LC020C	sim: 16	Spot	sim: 86 %	sim: 4.100	Bender Wirth: 479 Typ L1
LC040C	sim: 23	Spot	sim: 84 %	sim: 2.600	Bender Wirth: 480 Typ L1
ZC4/6	sim: 21	Spot	sim: 84 %	sim: 3.100	Bender Wirth: 434 Typ L1

D

C

B

A

4

4

3

3

2

2

1

1

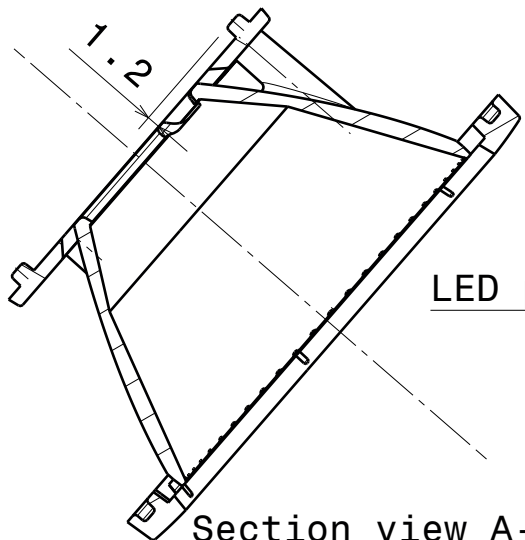

Section view A-A
Scale: 3:2

LED position

∅49.9

∅3.4

∅1.8

∅31.4

∅29

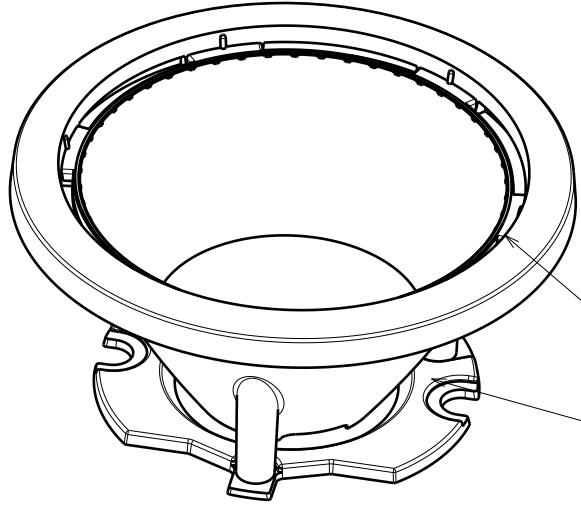

Reflector

Socket

Isometric view
Scale: 3:2

24

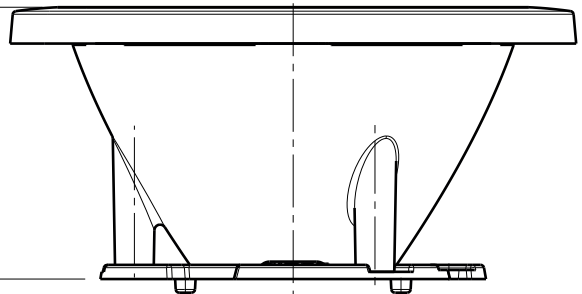

CN13918_MIRELLA-50-S-PF-VER013/18
CN13920_MIRELLA-50-M-PF-VER013/18
CN13923_MIRELLA-50-W-PF-VER013/18

NOTE: It is recommended to use glue like DELO-PUR 9895 for pin fastening.

[http://www.delo.de/fileadmin/datasheet/DELO-PUR_9895_\(TIDB-GB\).pdf](http://www.delo.de/fileadmin/datasheet/DELO-PUR_9895_(TIDB-GB).pdf)

Tolerances if not otherwise shown
According to DIN ISO 2768-1
Linear measures:
Up to 30mm class M, otherwise class C.
According to DIN ISO 2768-2
Form and position: class L

LEDiL
Ledil Oy
Salorankatu 10
FIN 24240 SALO
Finland

THIRD ANGLE PROJECTION:

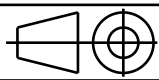

DRAWING TITLE
MIRELLA-50-PF-VER013/18

This drawing is the property of LEDiL Oy. It may not be reproduced, copied or communicated without a written agreement with LEDiL Oy."

SIZE	PART NUMBER		
A4	-		

SCALE	3:2	WEIGHT	-	SHEET	1/1
-------	-----	--------	---	-------	-----

D

A

Luminaire: LEDiL Oy C13085_MIRELLA-50-S-PF Eff.89.1%

Lamps: 1 x Bridgelux_VERO13_(BXRC-30E2000C)_989.57lm@250mA_P=7.48526W_I=249.8mA

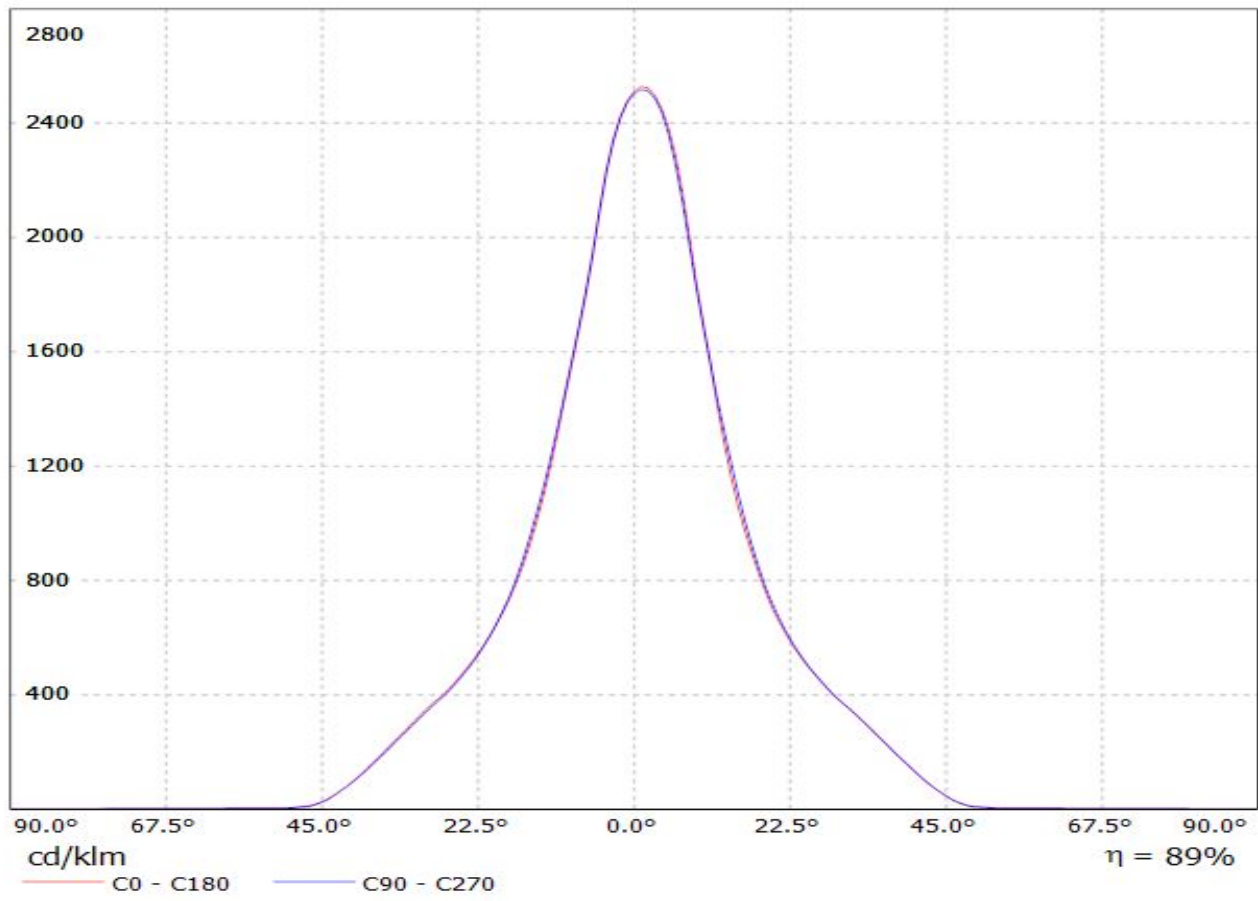

Luminaire: LEDiL Oy CN13918_MIRELLA-50-S-PF-VERO13_(XENIO_13MM)
Lamps: 1 x XENIO_13MM_2066.26lm@?mA_P=23W_I=?A

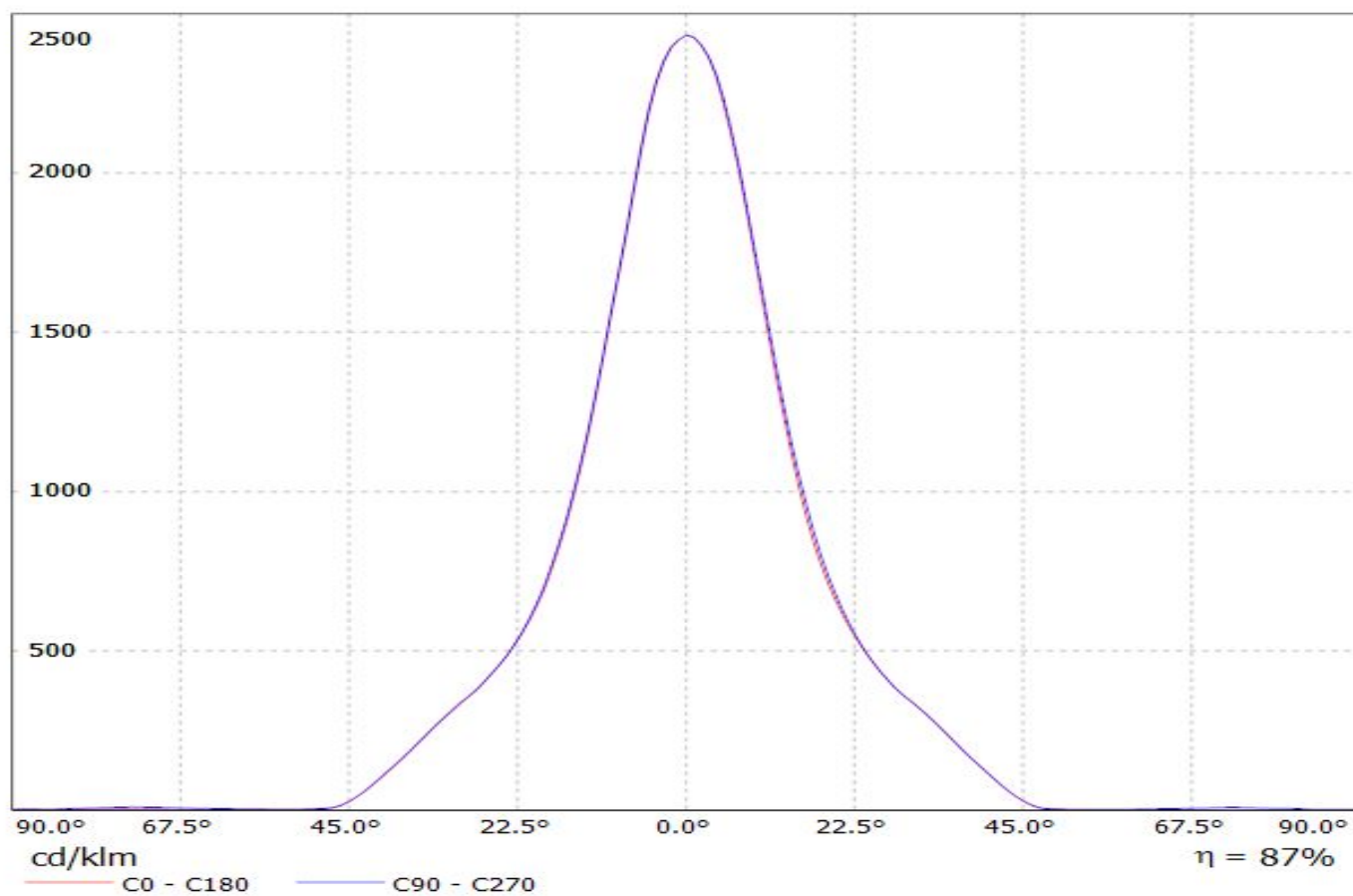

Luminaire: LEDiL Oy CN13918_MIRELLA-50-S-PF-VERO13_(V10_Gen7)
Lamps: 1 x Bridgelux_V10_Gen7_(BXRE-30G2000-B)_953.189lm@250mA_P=8.52368W_I=0.25A

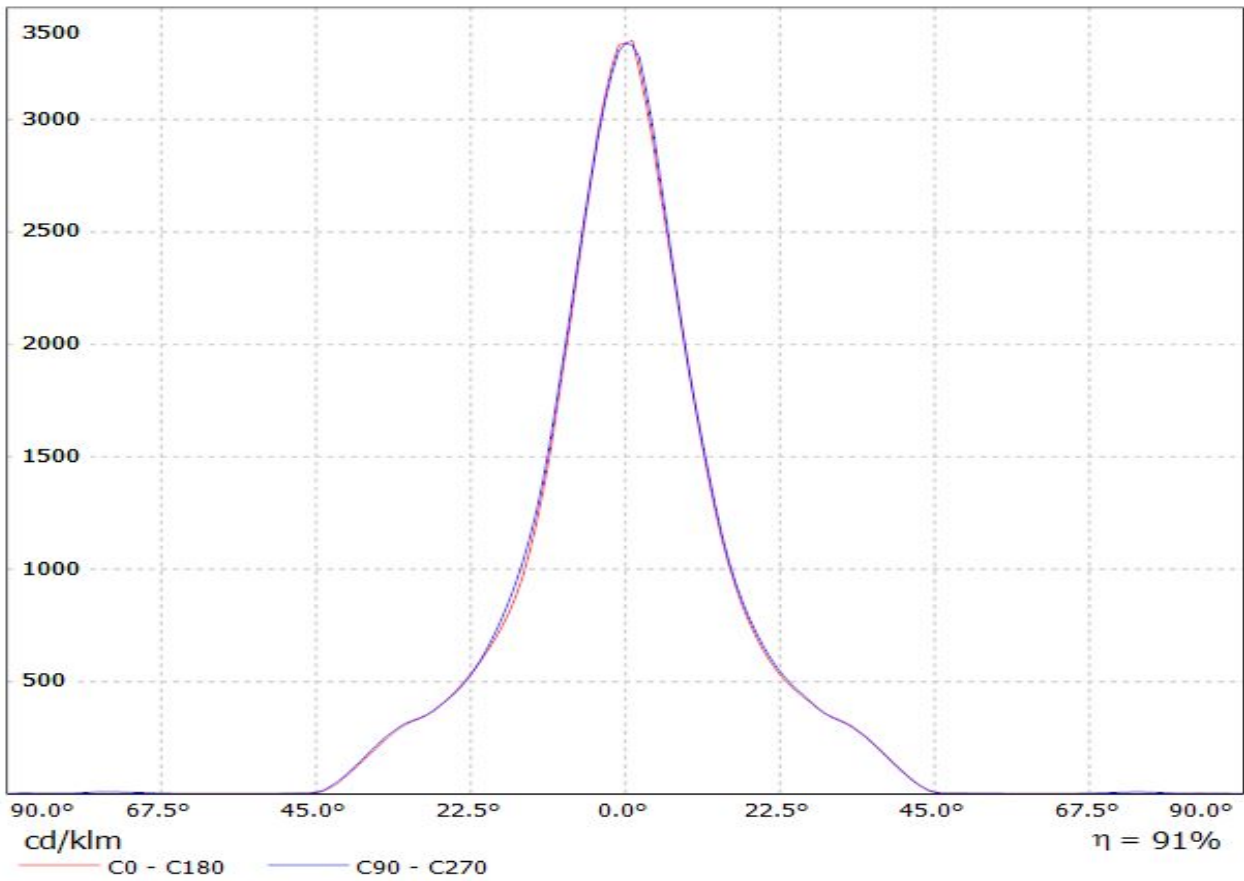

Ledil CN13918_MIRELLA-50-S-PF-VERO13_(CLU720) / LDC (Linear)

Luminaire: Ledil CN13918_MIRELLA-50-S-PF-VERO13_(CLU720)

Lamps: 1 x Citizen_(CLU720)_ (433_Typ_L1)_ (C13709)_ 1238.41lm@250mA_P=8.3W_I=0.25A

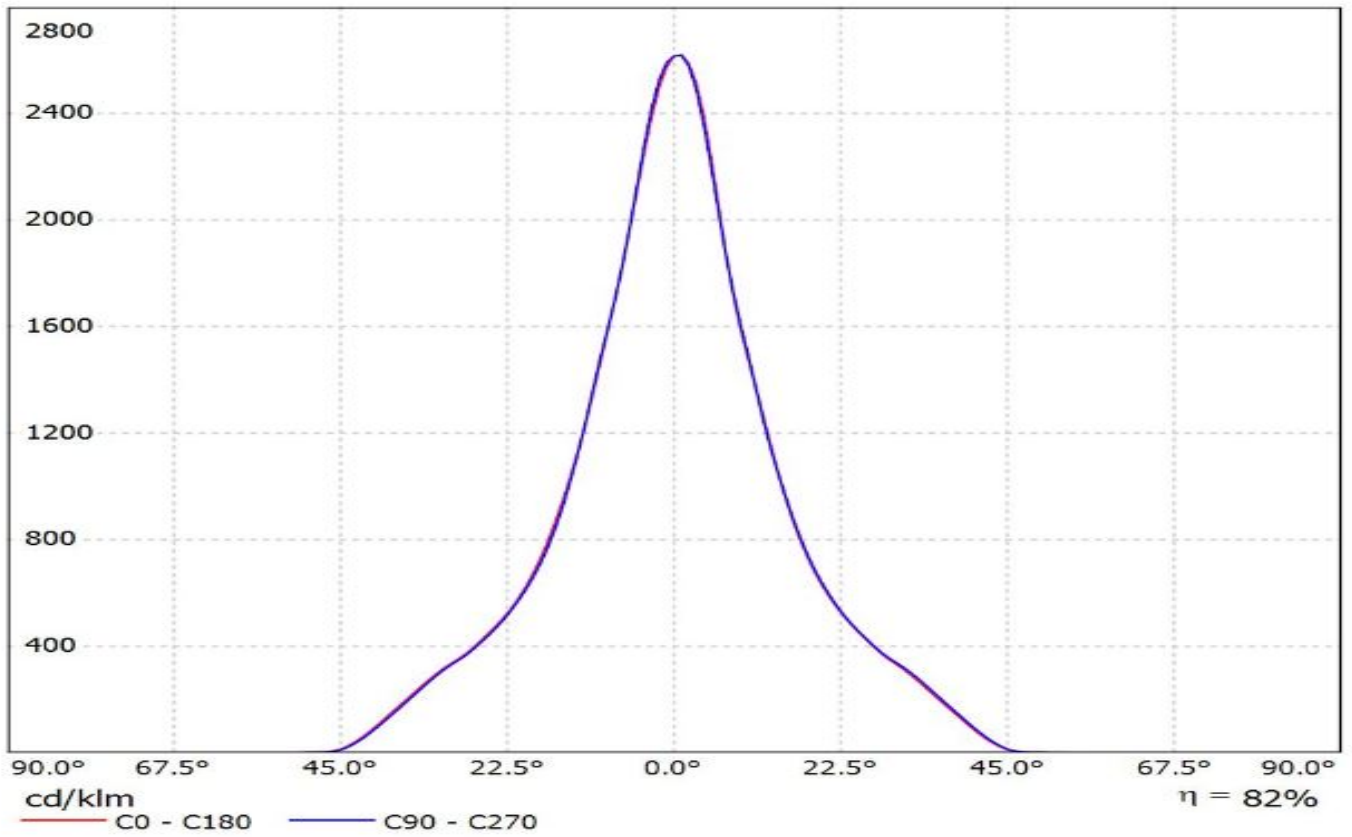

Luminaire: Ledil CN13918_MIRELLA-50-S-PF-VERO13_(CLU700) Citizen_CLU700_(CLU700-1002B8-273M2G1)_ (434_Typ_L1)_ (C13709_Pf-SOCKET-VERO13-18)_389.152lm@100mA_P=2.8W_I=0.10A
Lamps: 1 x Citizen_CLU700_(CLU700-1002B8-273M2G1)_ (434_Typ_L1)_ (C13709_Pf-SOCKET-VERO13-18)_389.152lm@100mA_P=2.8W_I=0.10A

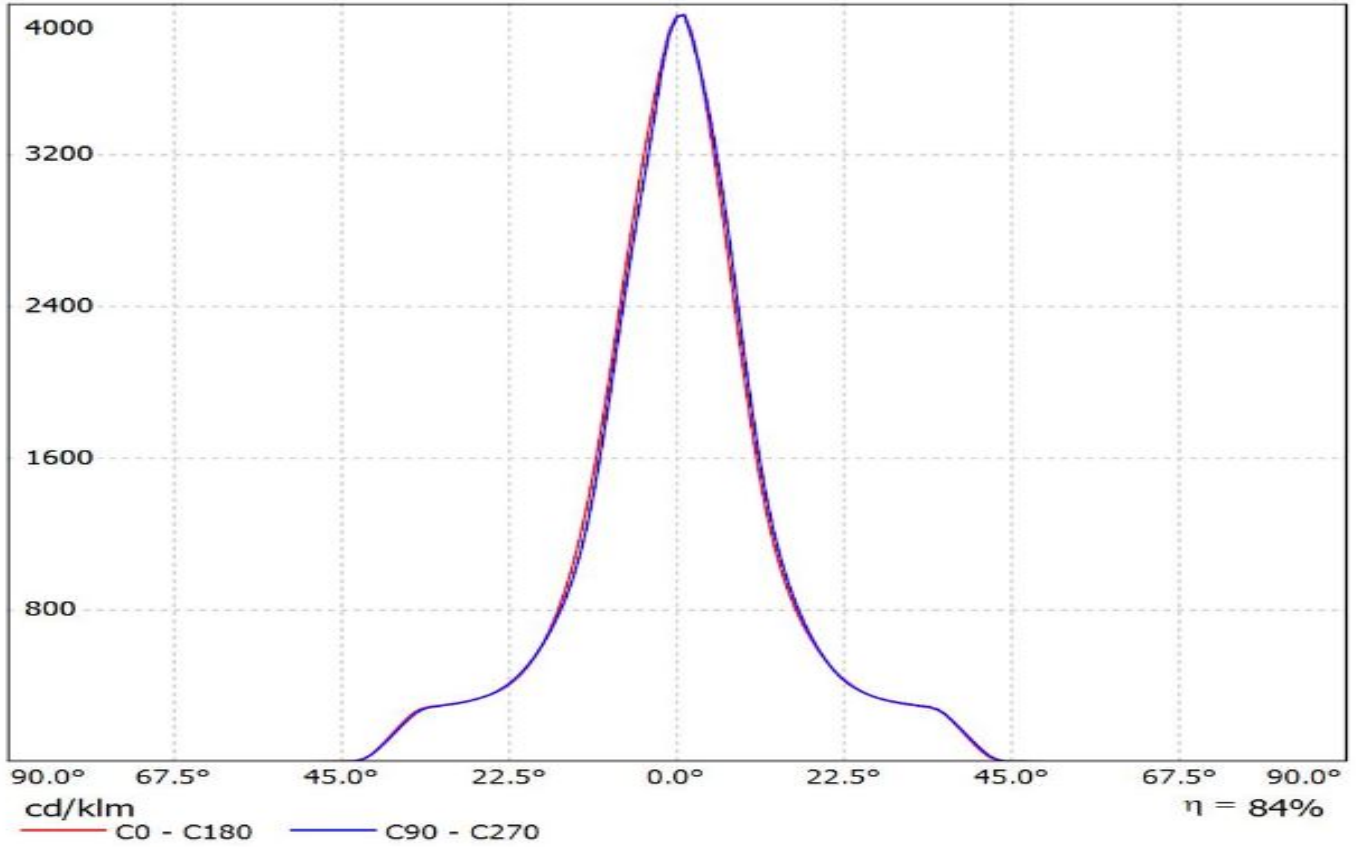

Luminaire: LEDiL Oy CN13918_MIRELLA-50-S-PF-VERO13_(CLU024) Citizen_CLU024_(434_Typ_L1)_(C13709)_1022.97lm@250mA_P=8.5066W_I=0.2499A
Lamps: 1 x Citizen_CLU024_(434_Typ_L1)_(C13709)_1022.97lm@250mA_P=8.5066W_I=0.2499A

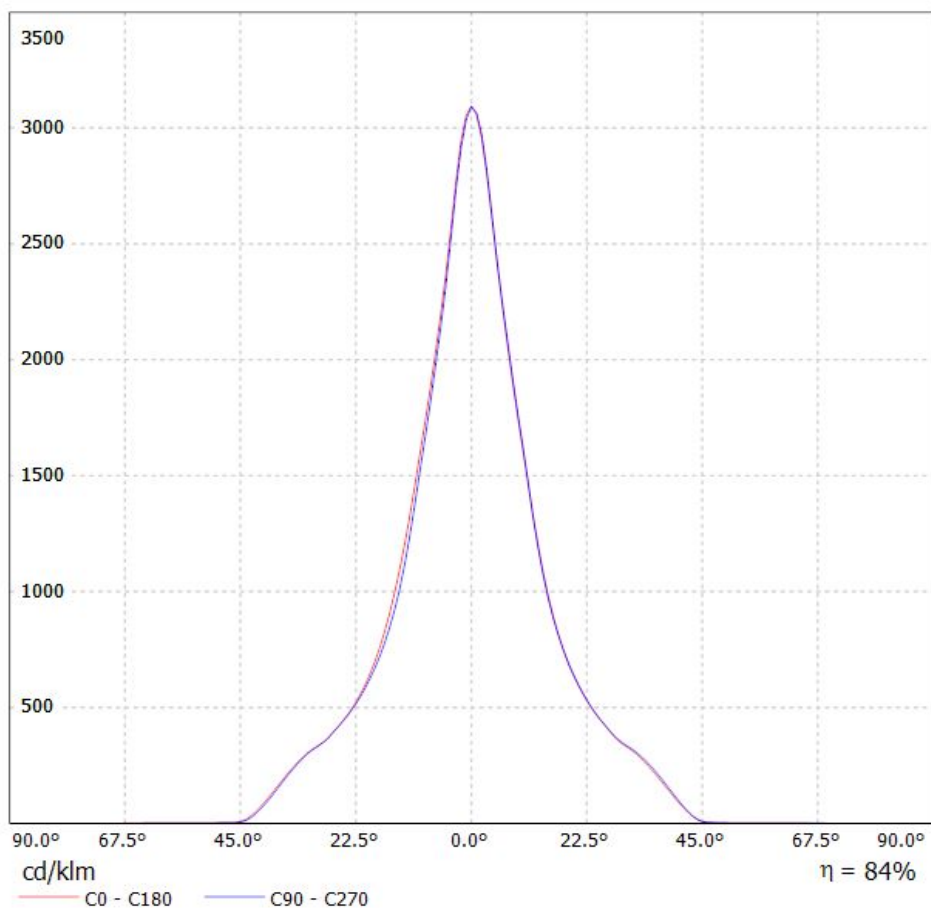

Luminaire: Ledil CN13918_MIRELLA-50-S-PF-VERO13_(CXA1520)_ (441_Typ_L1) CREE_CXA1520_(CXA1520-30F-N4-N0H-00001)_ (441_Typ_L1)_ (C13709_PF-SOCKET-VERO13-18)_1033.5lm@250mA_P=8.8W_I=0.25A
Lamps: 1 x CREE_CXA1520_(CXA1520-30F-N4-N0H-00001)_ (441_Typ_L1)_ (C13709_PF-SOCKET-VERO13-18)_1033.5lm@250mA_P=8.8W_I=0.25A

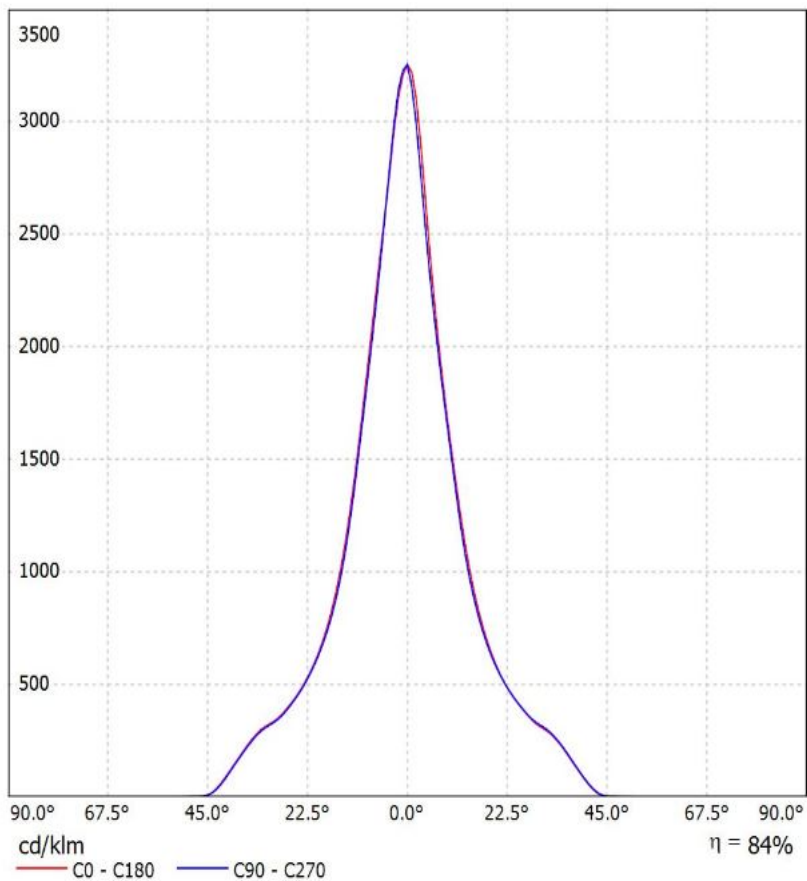

Luminaire: Ledil CN13918_MIRELLA-50-S-PF-VERO13_(CoB_1203)

Lamps: 1 x Luxeon_CoB_1203_(438 Typ L1)_1054.48lm@250mA_P=0.7_I=0.25A

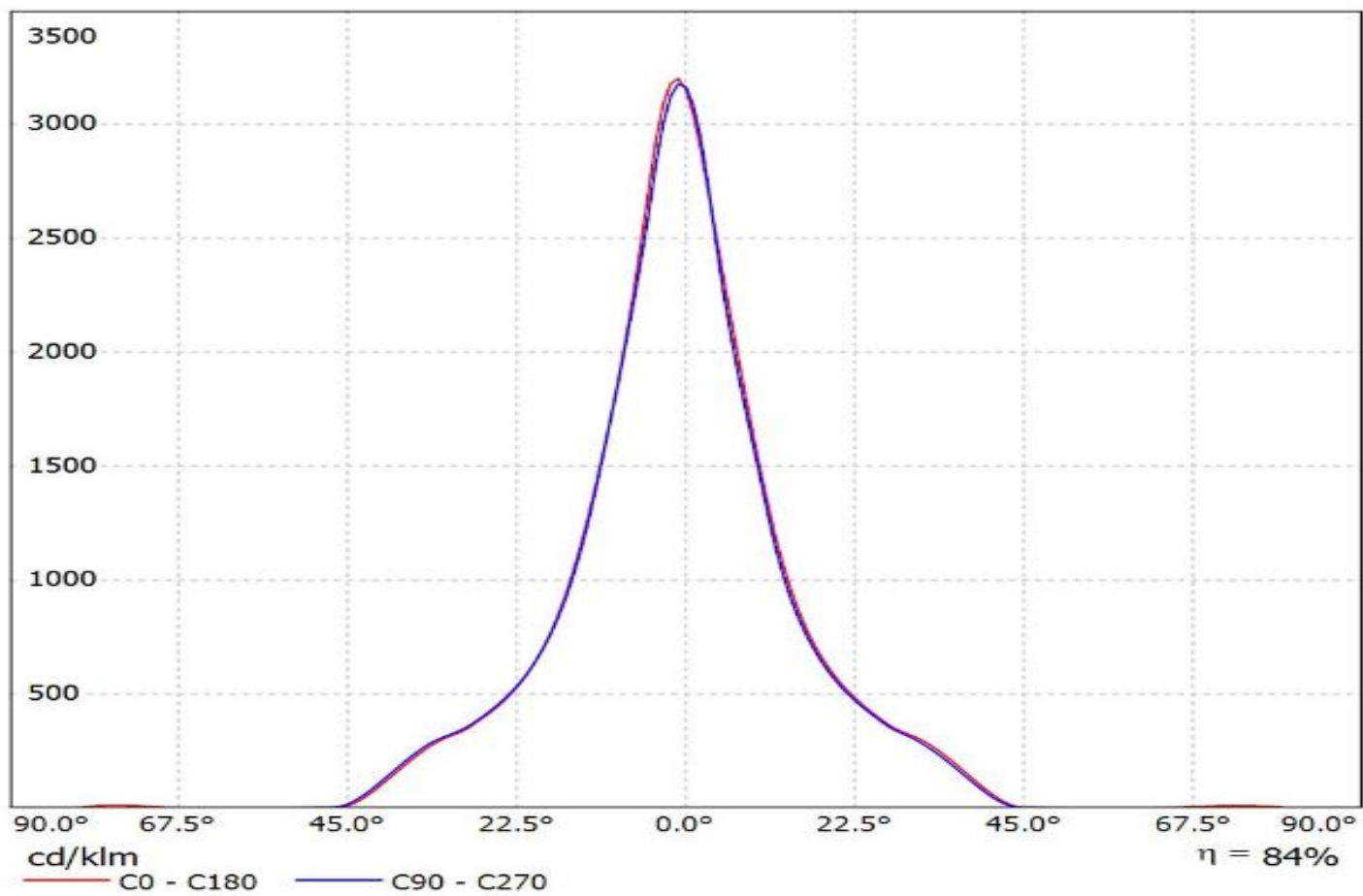

Luminaire: LEDiL Oy CN13918_MIRELLA-50-S-PF-VERO13_(NFCLL036B)

Lamps: 1 x Nichia NFCLL036B (sm403J1300R8000)_542.913lm@100mA_CCT=4000K_P=3.34084W_I=0.100A

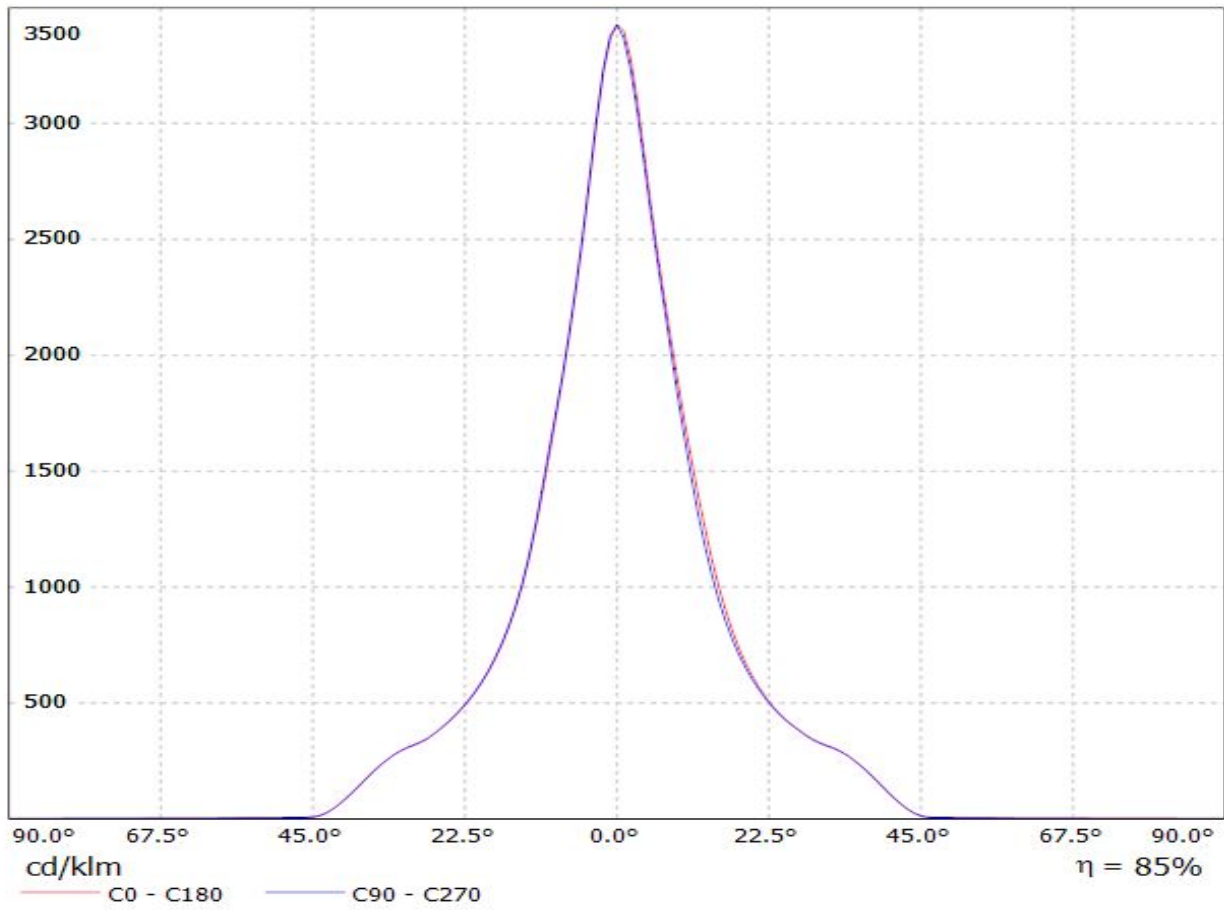

Luminaire: Ledil CN13918_MIRELLA-50-S-PF-VERO13_(NFCLL060B)

Lamps: 1 x Nichia_NFCLL060B_(438 Typ L1)_1355.59lm@250mA_P=8.5W_I=0.25A

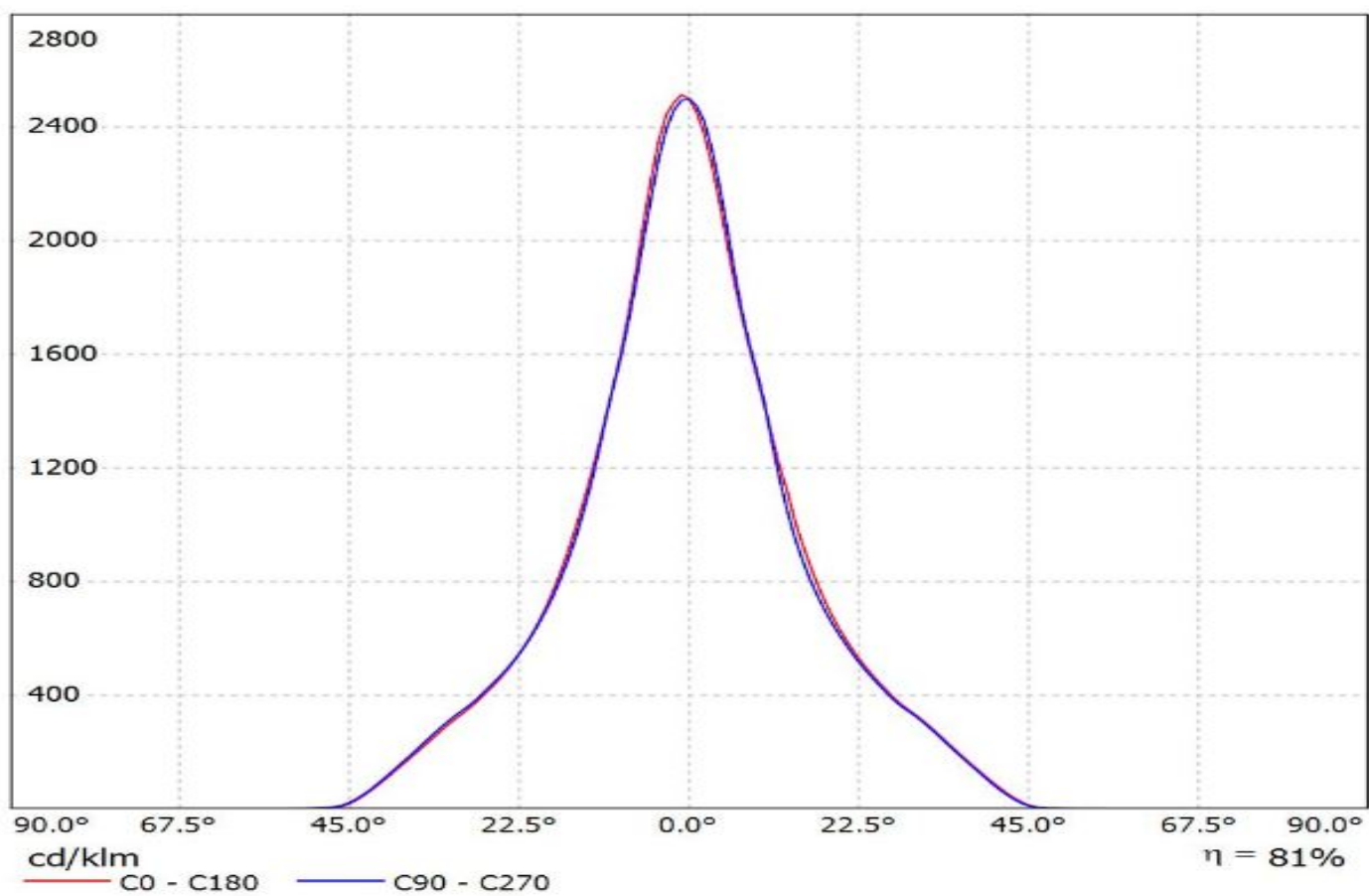

Luminaire: LEDiL Oy CN13918_MIRELLA-50-S-PF-VERO13_(Soleriq P9)
Lamps: 1 x Soleriq P9+461 Typ L1_881.86lm@250mA_P=6.96846W_I=250mA

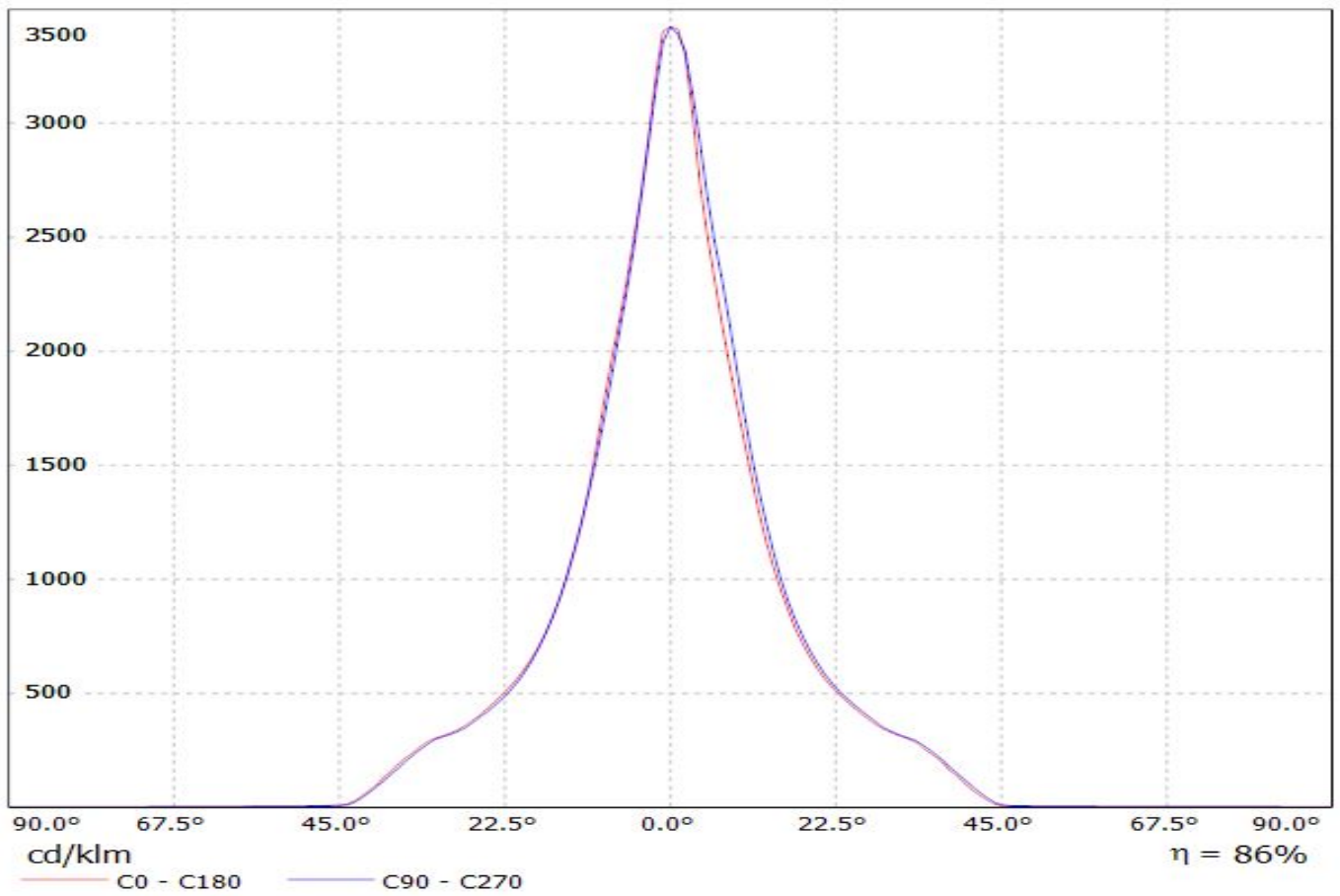

LEDiL Oy CN13918_MIRELLA-50-S-PF-VERO13_(Soleriq_P6) / LDC (Linear)

Luminaire: LEDiL Oy CN13918_MIRELLA-50-S-PF-VERO13_(Soleriq_P6)

Lamps: 1 x Osram_Soleriq_P6_(446 Typ L1)_464.246lm@250mA_P=6.28598W_I=0.25A

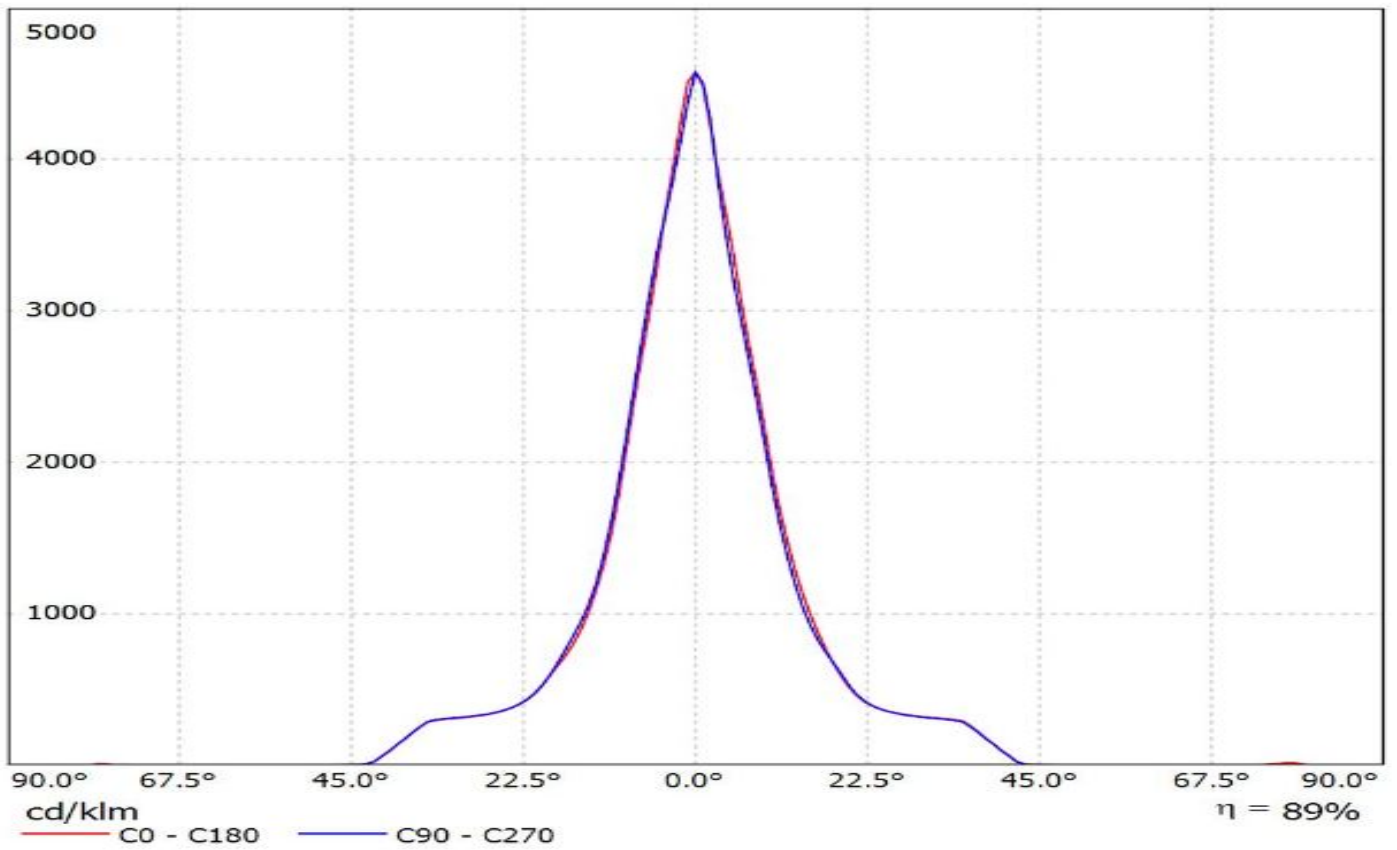

Luminaire: Ledil Oy CN13918_MIRELLA-50-S-PF-VERO13_(Soleriq_S9)_SIMULATED
Lamps: 1 x Osram Soleriq S9 (GW KAFJB3.EM)

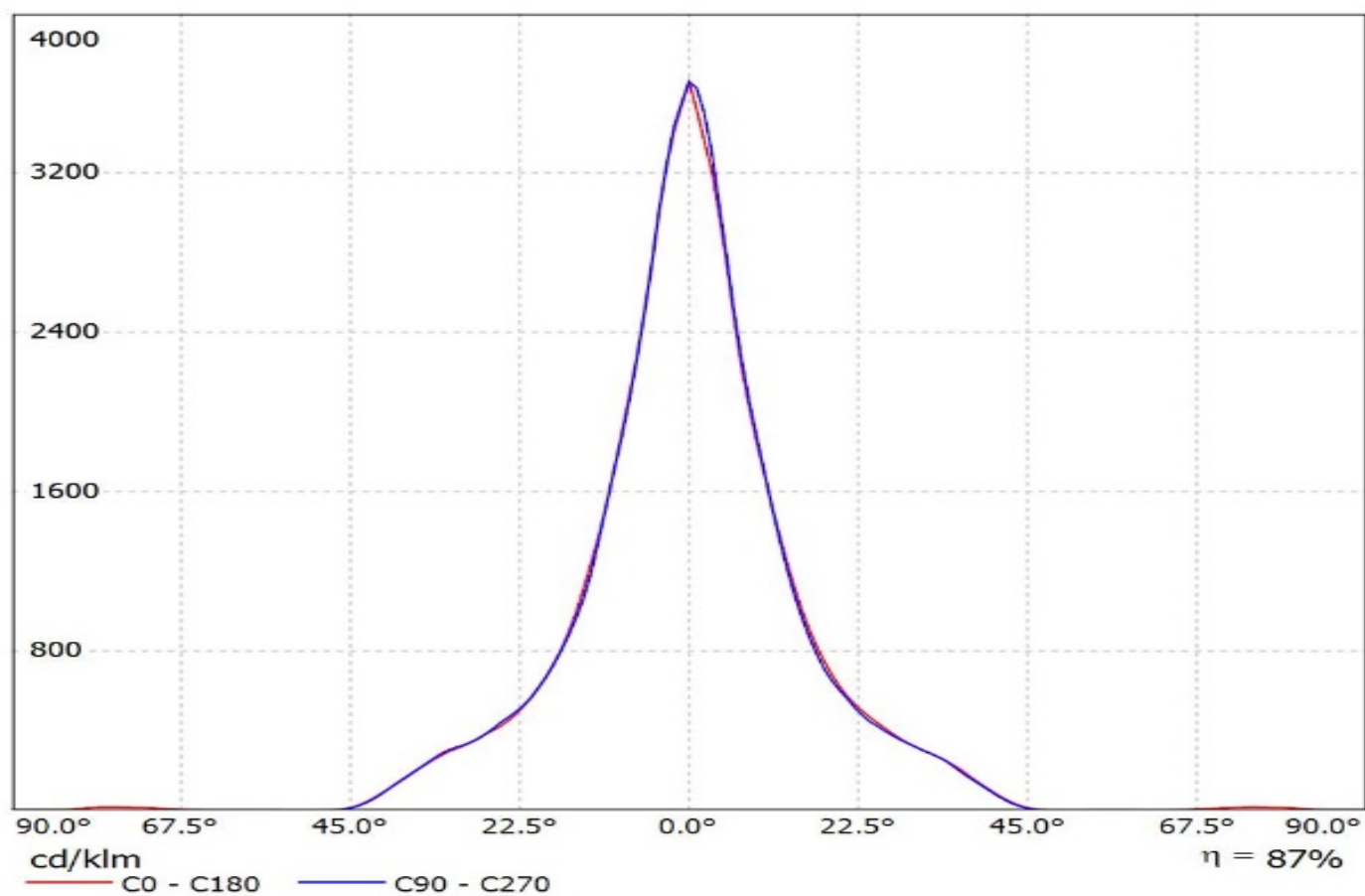

Luminaire: Ledil Oy CN13918_MIRELLA-50-S-PF-VERO13_(LC010C)_(479_type_L1)_SIMULATED
Lamps: 1 x Samsung LC010C + Bender & Wirth 479 Type L1

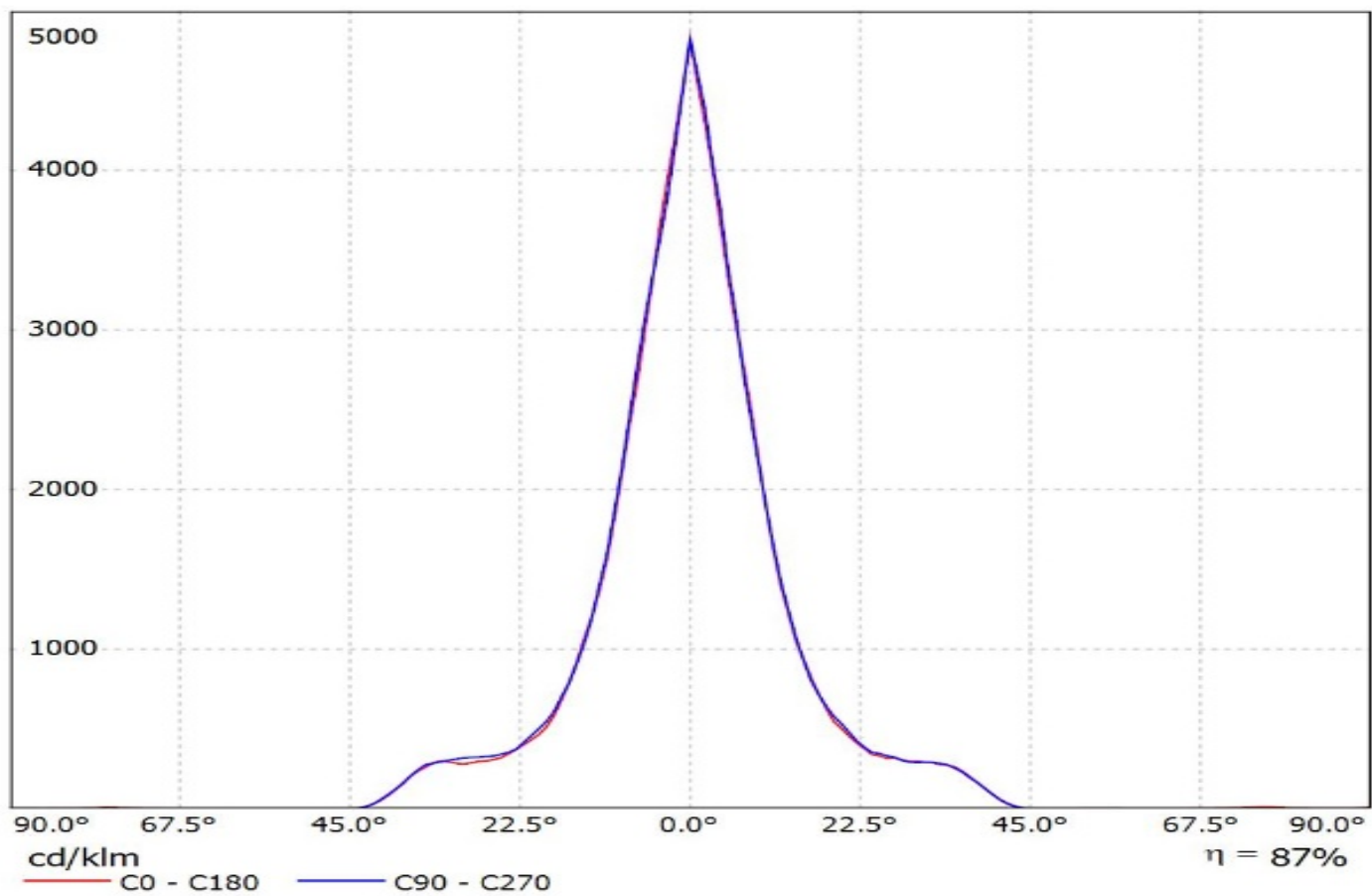

Luminaire: Ledil Oy CN13918_MIRELLA-50-S-PF-VERO13_(LC020C)_(479_type_L1)_SIMULATED
Lamps: 1 x Samsung LC020C + Bender & Wirth 479 Typ L1

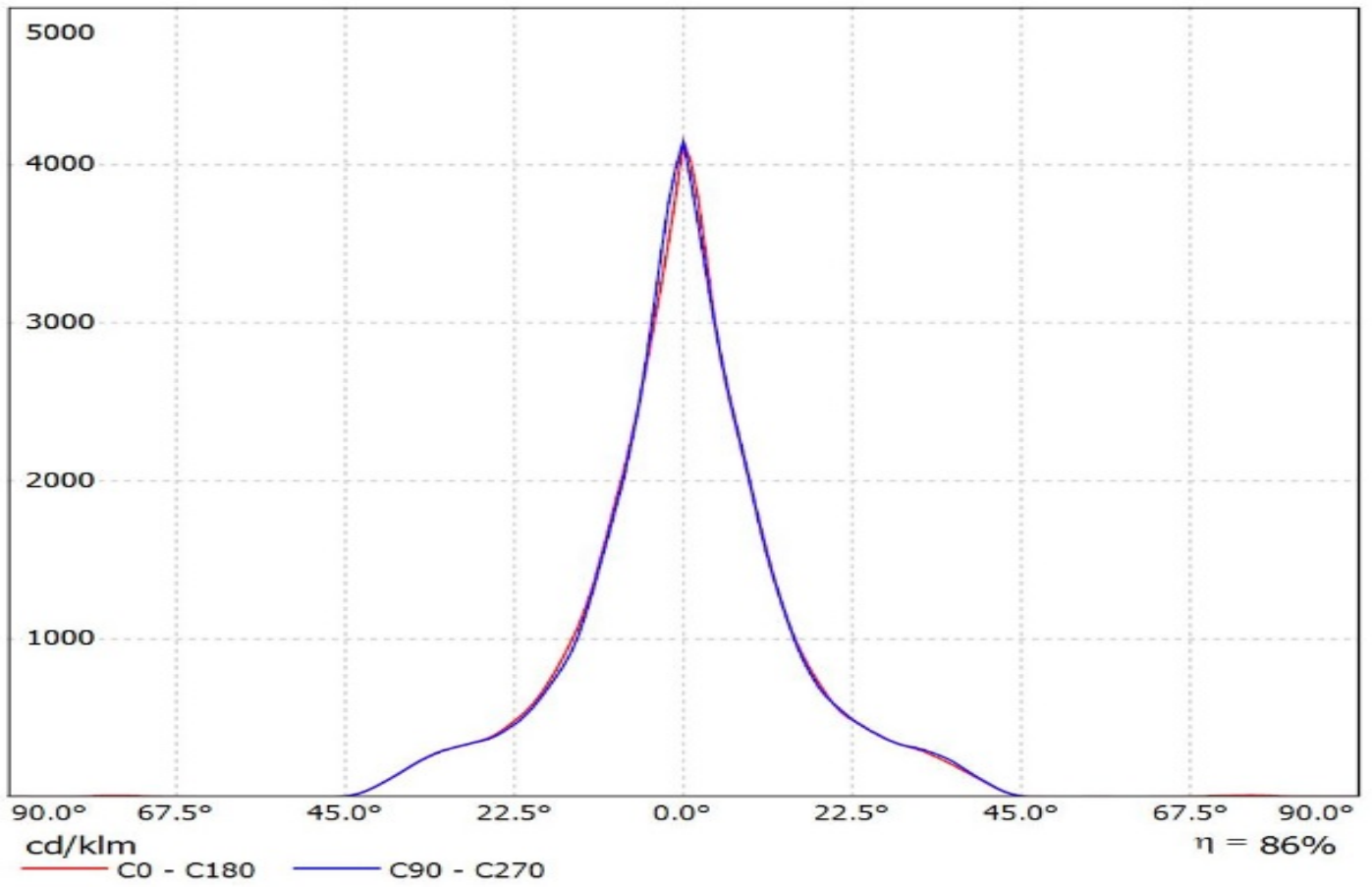

Luminaire: Ledil Oy CN13918_MIRELLA-50-S-PF-VERO13_(LC040C)_(480_type_L1)_SIMULATED
Lamps: 1 x Samsung LC040C + Bender & Wirth 480 Type L1

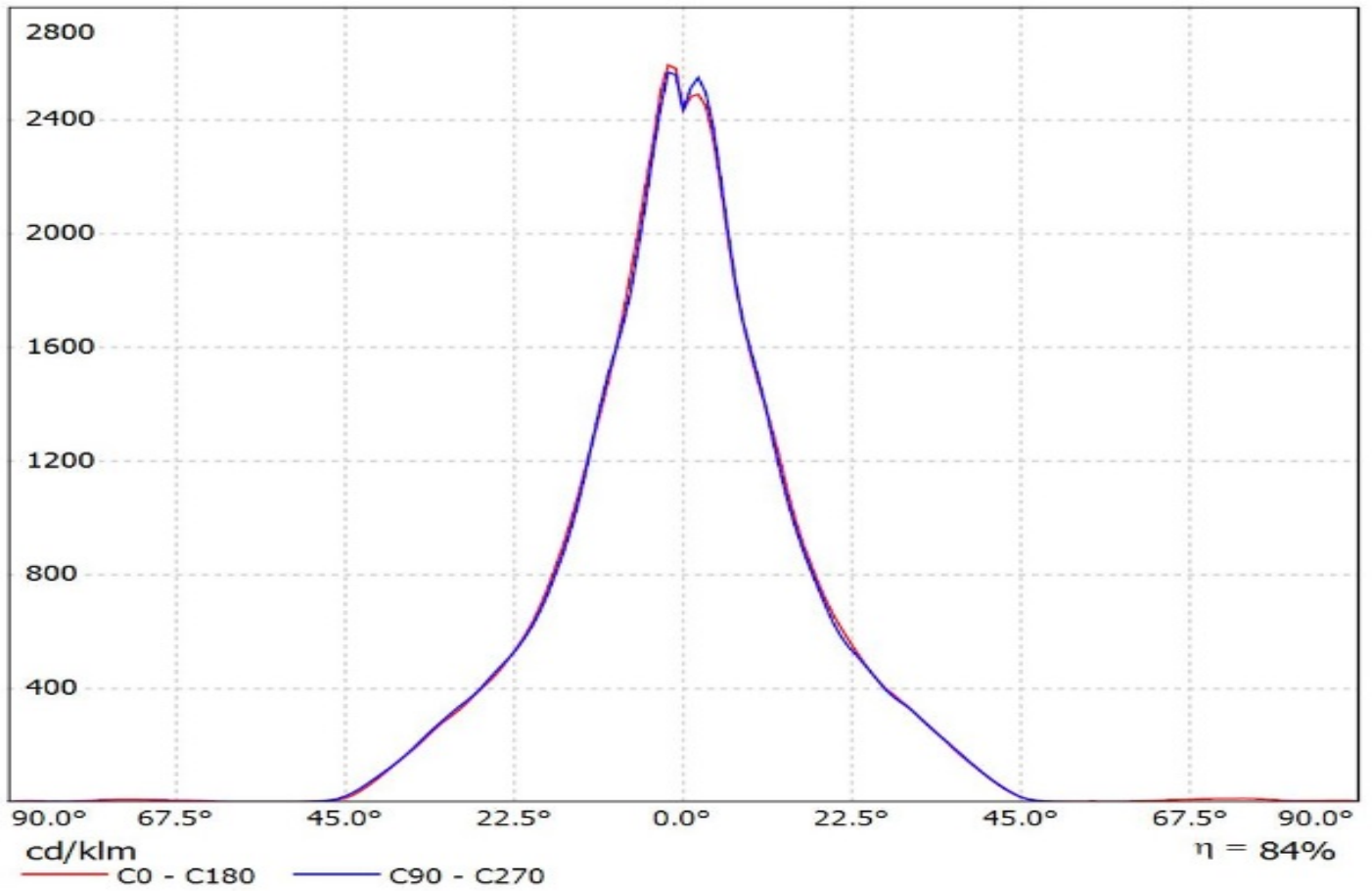

Luminaire: LEDiL Oy C13085_MIRELLA-50-S-PF Eff.89.1%

Lamps: 1 x Bridgelux_VERO13_(BXR30E2000C)_989.57lm@250mA_P=7.48526W_I=249.8mA

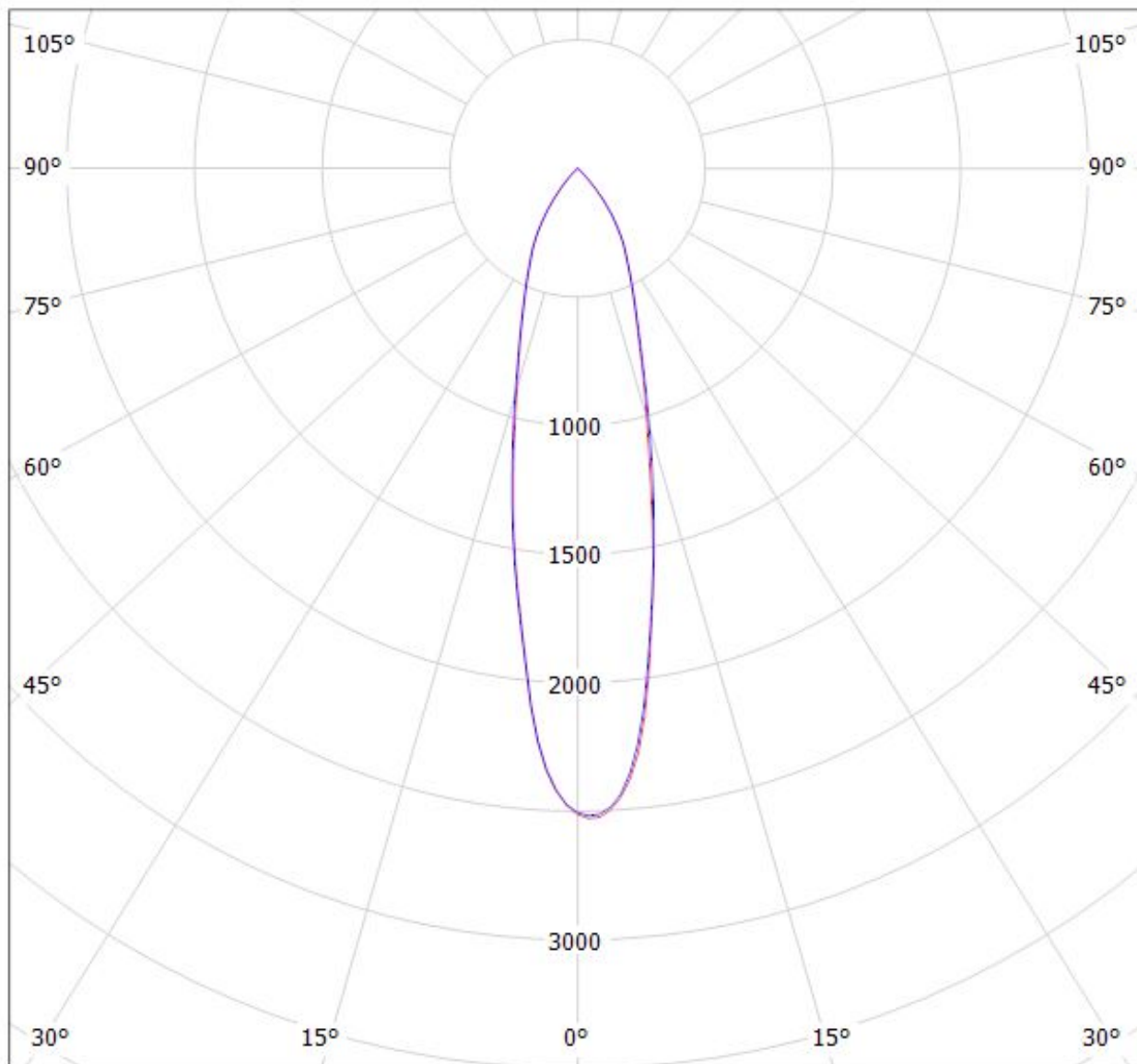

cd/klm

— C0 - C180 — C90 - C270

$\eta = 89\%$

Luminaire: LEDiL Oy CN13918_MIRELLA-50-S-PF-VERO13_(XENIO_13MM)
Lamps: 1 x XENIO_13MM_2066.26lm@?mA_P=23W_I=?A

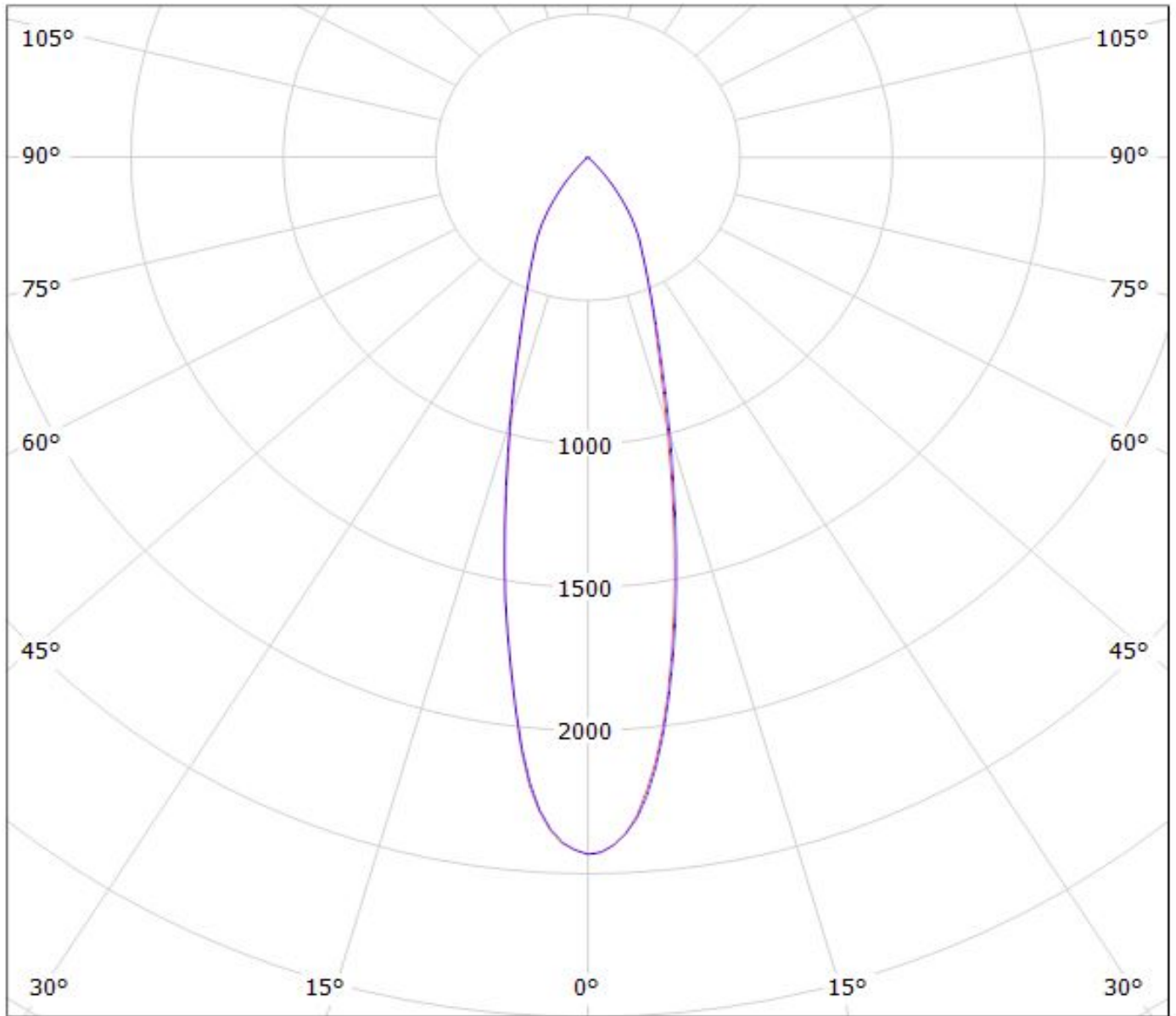

cd/klm

— C0 - C180

— C90 - C270

$\eta = 87\%$

Luminaire: LEDiL Oy CN13918_MIRELLA-50-S-PF-VERO13_(V10_Gen7)

Lamps: 1 x Bridgelux_V10_Gen7_(BXRE-30G2000-B)_953.189lm@250mA_P=8.52368W_I=0.25A

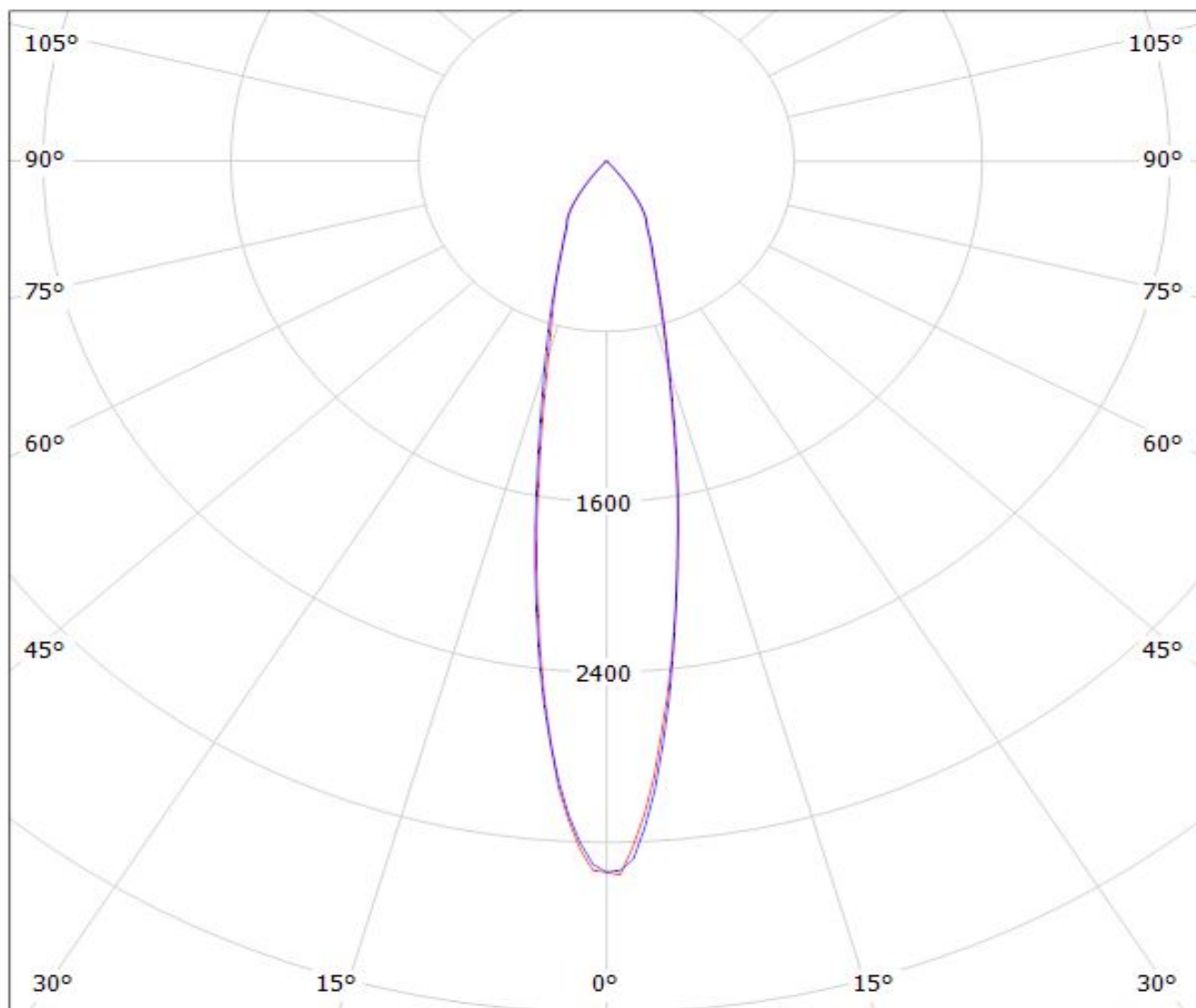

cd/klm

— C0 - C180 — C90 - C270

$\eta = 91\%$

Ledil CN13918_MIRELLA-50-S-PF-VERO13_(CLU720) / LDC (Polar)

Luminaire: Ledil CN13918_MIRELLA-50-S-PF-VERO13_(CLU720)

Lamps: 1 x Citizen_(CLU720)_ (433_Typ_L1)_ (C13709)_ 1238.41lm@250mA_P=8.3W_I=0.25A

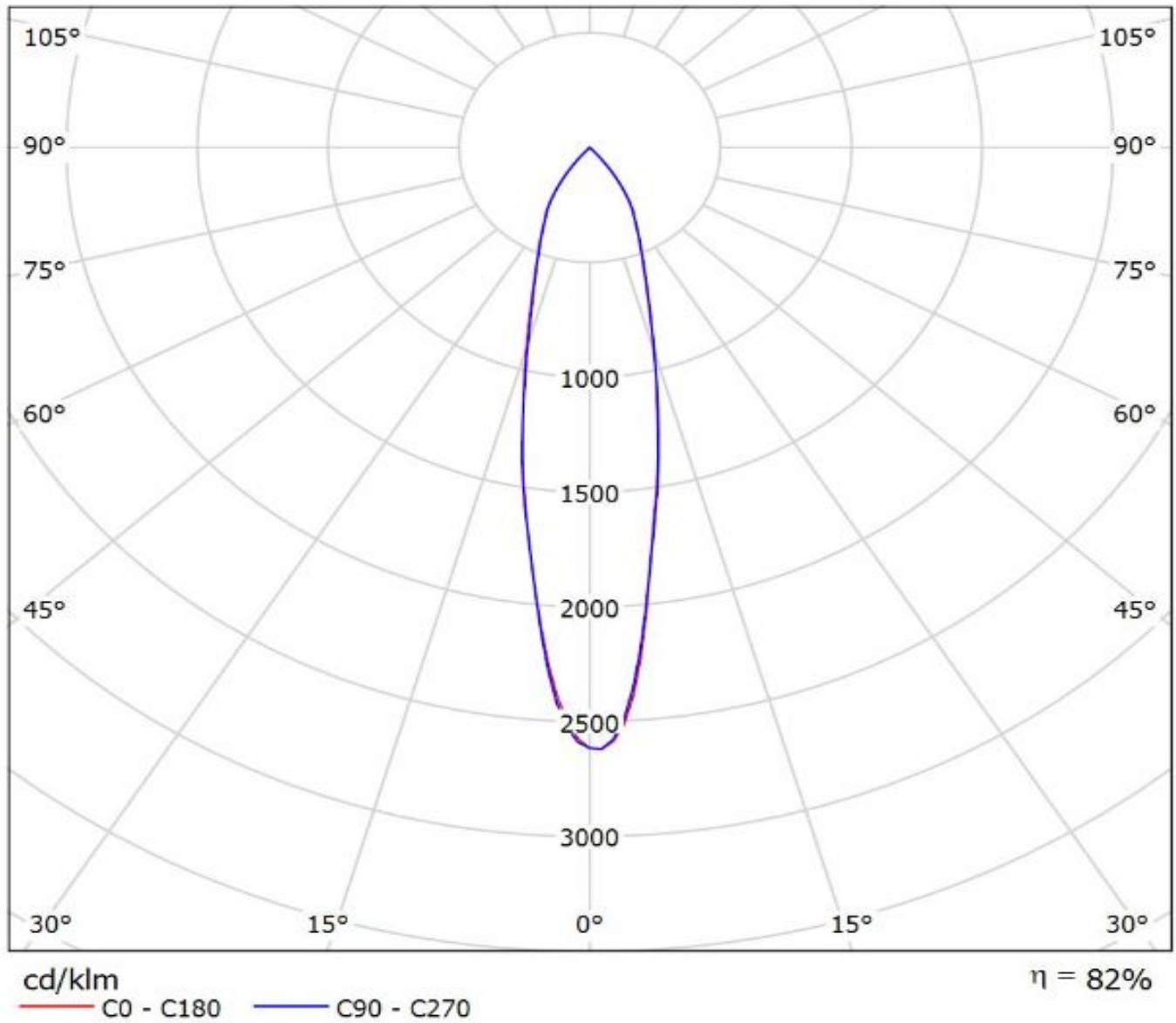

Luminaire: Ledil CN13918_MIRELLA-50-S-PF-VERO13_(CLU700) Citizen_CLU700_(CLU700-1002B8-273M2G1)_ (434_Typ_L1)_ (C13709_PF-SOCKET-VERO13-18)_389.152lm@100mA_P=2.8W_I=0.10A
Lamps: 1 x Citizen_CLU700_(CLU700-1002B8-273M2G1)_ (434_Typ_L1)_ (C13709_PF-SOCKET-VERO13-18)_389.152lm@100mA_P=2.8W_I=0.10A

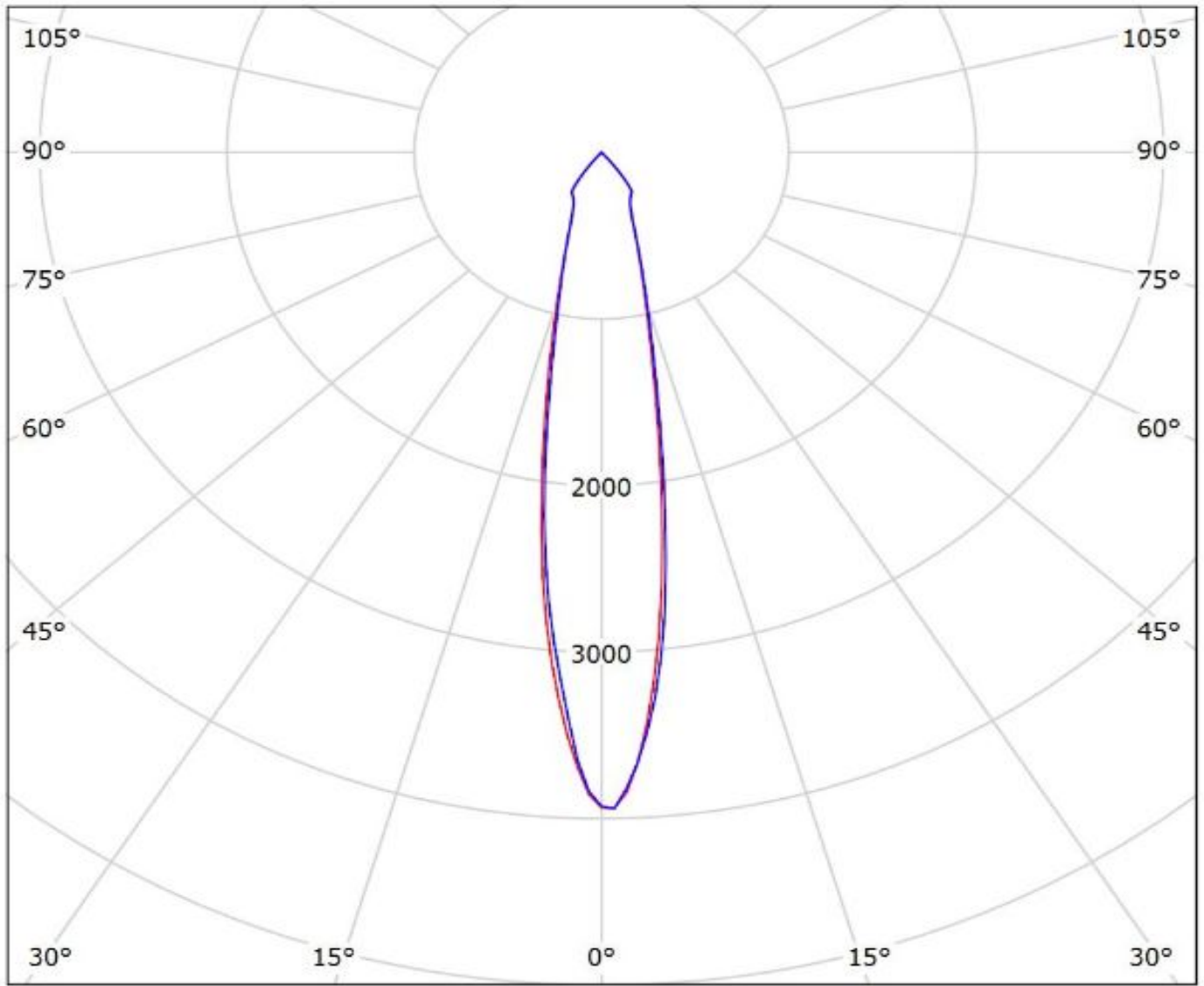

cd/klm

— C0 - C180 — C90 - C270

$\eta = 84\%$

Luminaire: LEDiL Oy CN13918_MIRELLA-50-S-PF-VERO13_(CLU024) Citizen_CLU024_(434_Typ_L1)_(C13709)_1022.97lm@250mA_P=8.5066W_l=0.2499A
Lamps: 1 x Citizen_CLU024_(434_Typ_L1)_(C13709)_1022.97lm@250mA_P=8.5066W_l=0.2499A

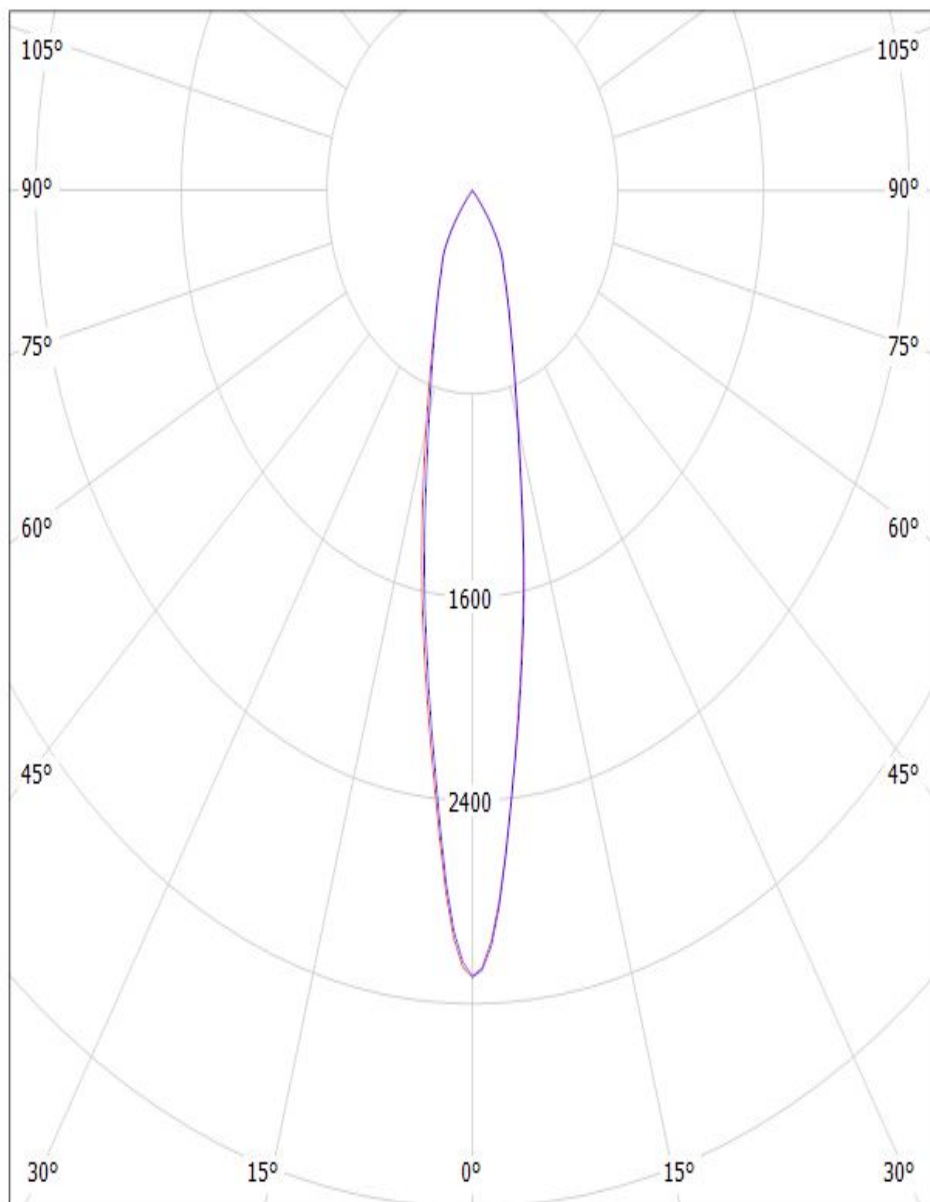

cd/klm

$\eta = 84\%$

— C0 - C180 — C90 - C270

Luminaire: Ledil CN13918_MIRELLA-50-S-PF-VERO13_(CXA1520)_(441_Typ_L1) CREE_CXA1520_(CXA1520-30F-N4-N0H-00001)_(441_Typ_L1)_(C13709_PF-SOCKET-VERO13-18)_1033.5lm@250mA_P=8.8W_I=0.25A
Lamps: 1 x CREE_CXA1520_(CXA1520-30F-N4-N0H-00001)_(441_Typ_L1)_(C13709_PF-SOCKET-VERO13-18)_1033.5lm@250mA_P=8.8W_I=0.25A

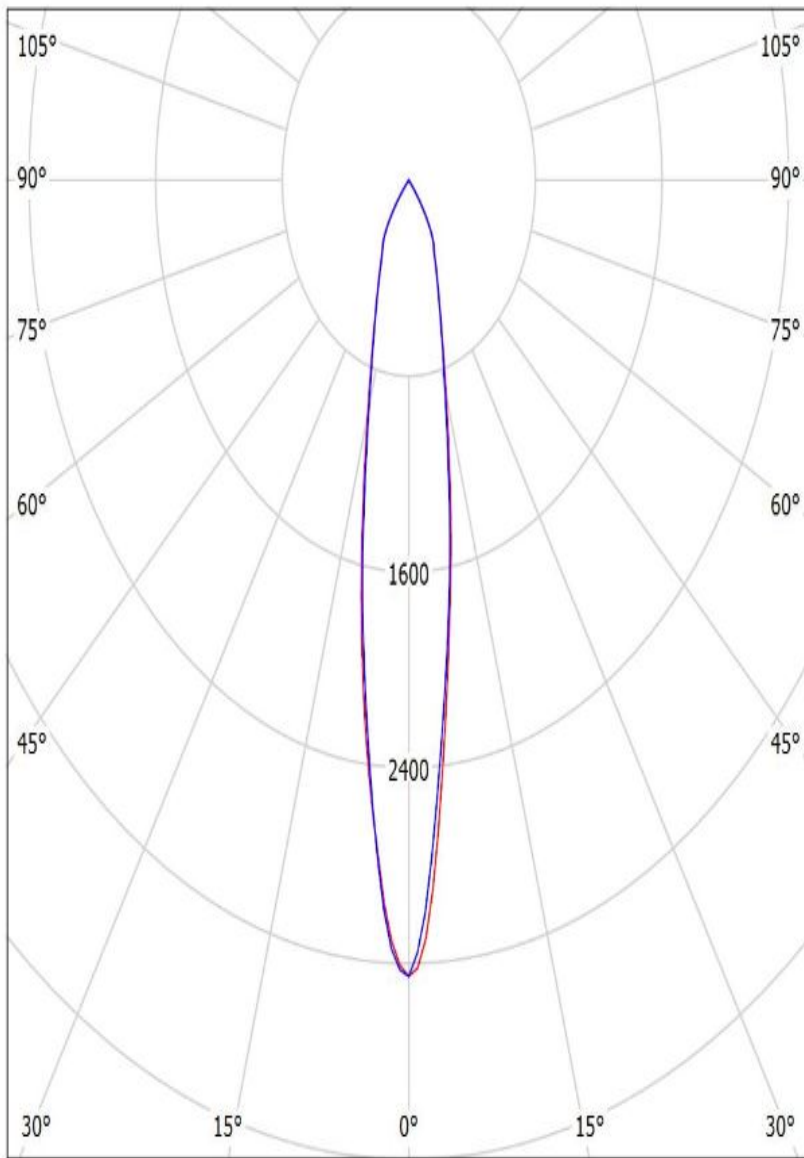

cd/klm

— C0 - C180 — C90 - C270

$\eta = 84\%$