



Chipsmall Limited consists of a professional team with an average of over 10 year of expertise in the distribution of electronic components. Based in Hongkong, we have already established firm and mutual-benefit business relationships with customers from,Europe,America and south Asia,supplying obsolete and hard-to-find components to meet their specific needs.

With the principle of “Quality Parts,Customers Priority,Honest Operation,and Considerate Service”,our business mainly focus on the distribution of electronic components. Line cards we deal with include Microchip,ALPS,ROHM,Xilinx,Pulse,ON,Everlight and Freescale. Main products comprise IC,Modules,Potentiometer,IC Socket,Relay,Connector.Our parts cover such applications as commercial,industrial, and automotives areas.

We are looking forward to setting up business relationship with you and hope to provide you with the best service and solution. Let us make a better world for our industry!



Contact us

Tel: +86-755-8981 8866 Fax: +86-755-8427 6832

Email & Skype: info@chipsmall.com Web: www.chipsmall.com

Address: A1208, Overseas Decoration Building, #122 Zhenhua RD., Futian, Shenzhen, China



DETAILS

Product Number	CN13923_MIRELLA-50-W-PF-VERO13
Family	Mirella
Type	RefPack
Color	metal
Diameter	49,9 mm
Height	24 mm
Style	round
Optic Material	
Holder Material	
Fastening	
Status	production ready
ROHS Compliant	Yes
Date Updated	6/03/2017



OPTICAL PROPERTIES

LED	Viewing	Light	Efficiency		Connector
	Angle	Beam	cd/lm		
VERO13	46 deg	Wide	90 %	1.290	-
V6 Gen6	27 deg	Wide	82 %	2.690	Bender Wirth: 460 Typ L1
Xenio Point 13mm	45 deg	Wide	85 %	1.260	-
CLU720/721	40 deg	Wide	81 %	1.400	Bender Wirth: 433 Typ L1
CLU700/701	26 deg	Wide	83 %	2.400	Bender Wirth: 434 Typ L1
CLL02x/CLU02x (LES10)	36 deg	Wide	84 %	1.700	Bender Wirth: 434 Typ L1
CXA/B 15xx	34 deg	Wide	82 %	1.800	Bender Wirth: 441 Typ L1
LUXEON CoB 1202/1203	35 deg	Wide	83 %	1.700	Bender Wirth: 438 Typ L1
LUXEON CoB 1202s	25 deg	Wide	85 %	2.600	Bender Wirth: 452 Typ L1
LUXEON CoB Compact	sim: 25	Wide	sim: 85 %	sim: 2.600	Bender Wirth: 452 Typ L1
CXM-14	sim: 49	Wide	sim: 75 %	sim: 1.000	Bender Wirth: 433 Typ L1
CXM-9	sim: 36	Wide	sim: 84 %	sim: 1.700	Bender Wirth: 434 Typ L1
COB L-Type (LES 9)	34 deg	Wide	84 %	1.800	Bender Wirth: 438 Typ L1
COB S-Type	sim: 25	Wide	sim: 85 %	sim: 2.600	Bender Wirth: 452 Typ L1
COB L-Type (LES 11)	41 deg	Wide	81 %	1.400	Bender Wirth: 438 Typ L1
Soleriq P9	34 deg	Wide	85 %	1.800	Bender Wirth: 461 Typ L1
Soleriq P6	28 deg	Wide	87 %	2.400	Bender Wirth: 446 Typ L1
Soleriq S9	sim: 38	Wide	sim: 88 %	sim: 1.700	-
Soleriq S15	sim: 56	Wide	sim: 86 %	sim: 1.081	Bender Wirth: 433 Typ L1
LC010C	sim: 32	Wide	sim: 87 %	sim: 2.200	Bender Wirth: 479 Typ L1
LC020C	sim: 35	Wide	sim: 86 %	sim: 1.900	Bender Wirth: 479 Typ L1
LC040C	sim: 42	Wide	sim: 84 %	sim: 1.400	Bender Wirth: 480 Typ L1
ZC4/6	sim: 36	Wide	sim: 84 %	sim: 1.700	Bender Wirth: 434 Typ L1

Relative intensity of CN13923_MIRELLA-50-W-PF-VERO13_(V6)

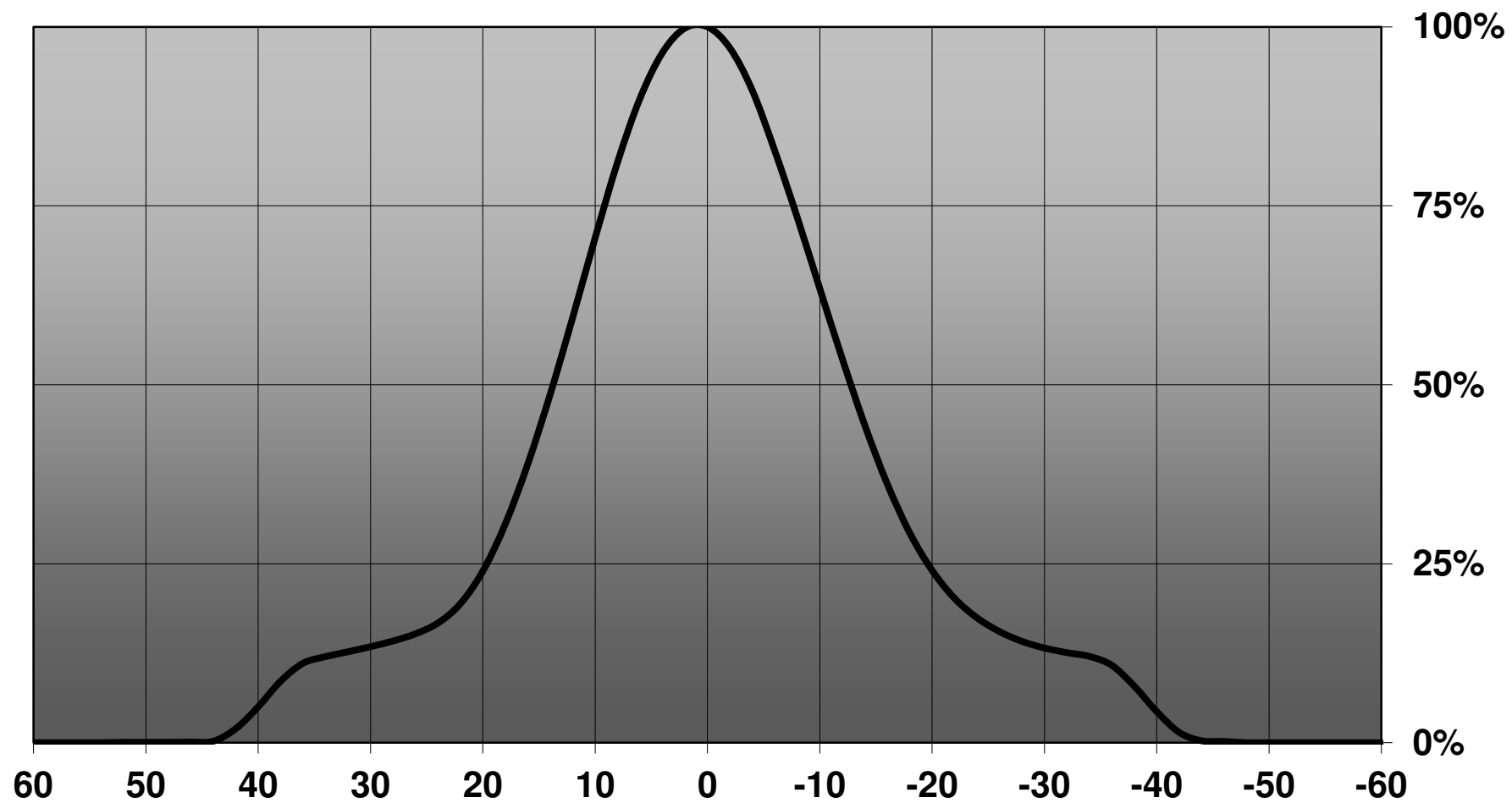

D

C

B

A

4

4

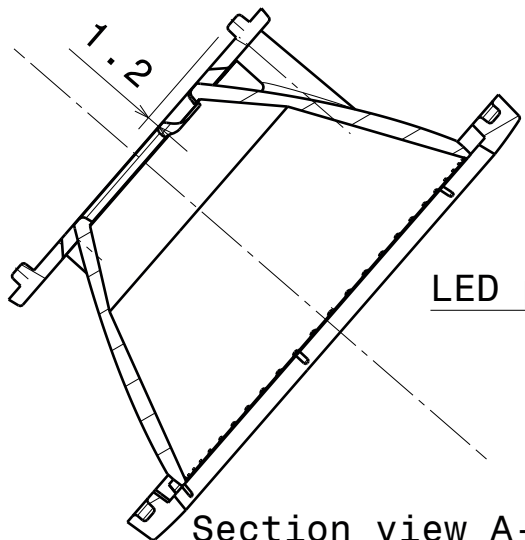

Section view A-A
Scale: 3:2

LED position

∅49.9

∅3.4

∅1.8

∅31.4

∅29

3

3

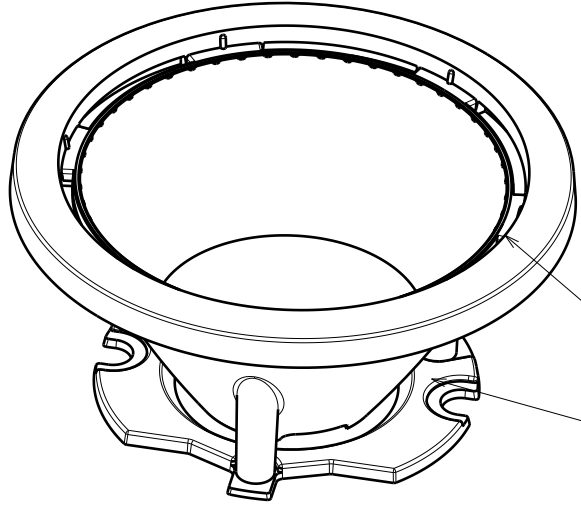

Isometric view
Scale: 3:2

Reflector

Socket

24

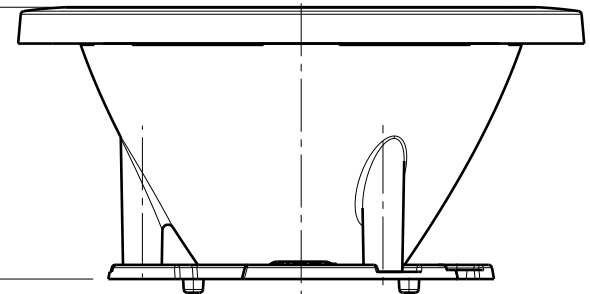

2

2

CN13918_MIRELLA-50-S-PF-VER013/18
CN13920_MIRELLA-50-M-PF-VER013/18
CN13923_MIRELLA-50-W-PF-VER013/18

NOTE: It is recommended to use glue like DELO-PUR 9895 for pin fastening.

[http://www.delo.de/fileadmin/datasheet/DELO-PUR_9895_\(TIDB-GB\).pdf](http://www.delo.de/fileadmin/datasheet/DELO-PUR_9895_(TIDB-GB).pdf)

Tolerances if not otherwise shown
According to DIN ISO 2768-1
Linear measures:
Up to 30mm class M, otherwise class C.
According to DIN ISO 2768-2
Form and position: class L



Ledil Oy
Salorankatu 10
FIN 24240 SALO
Finland

THIRD ANGLE PROJECTION:

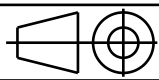

DRAWING TITLE
MIRELLA-50-PF-VER013/18

This drawing is the property of LEDiL Oy. It may not be reproduced, copied or communicated without a written agreement with LEDiL Oy."

SIZE	PART NUMBER		
A4	-		

SCALE	3:2	WEIGHT	-	SHEET	1/1
-------	-----	--------	---	-------	-----

1

1

D

A

Luminaire: LEDiL Oy C13087_MIRELLA-50-W-PF Eff.89.9%
Lamps: 1 x Bridgelux_VERO13_(BXRC-30E2000C)_989.57lm@250mA_P=7.48526W_I=249.8mA

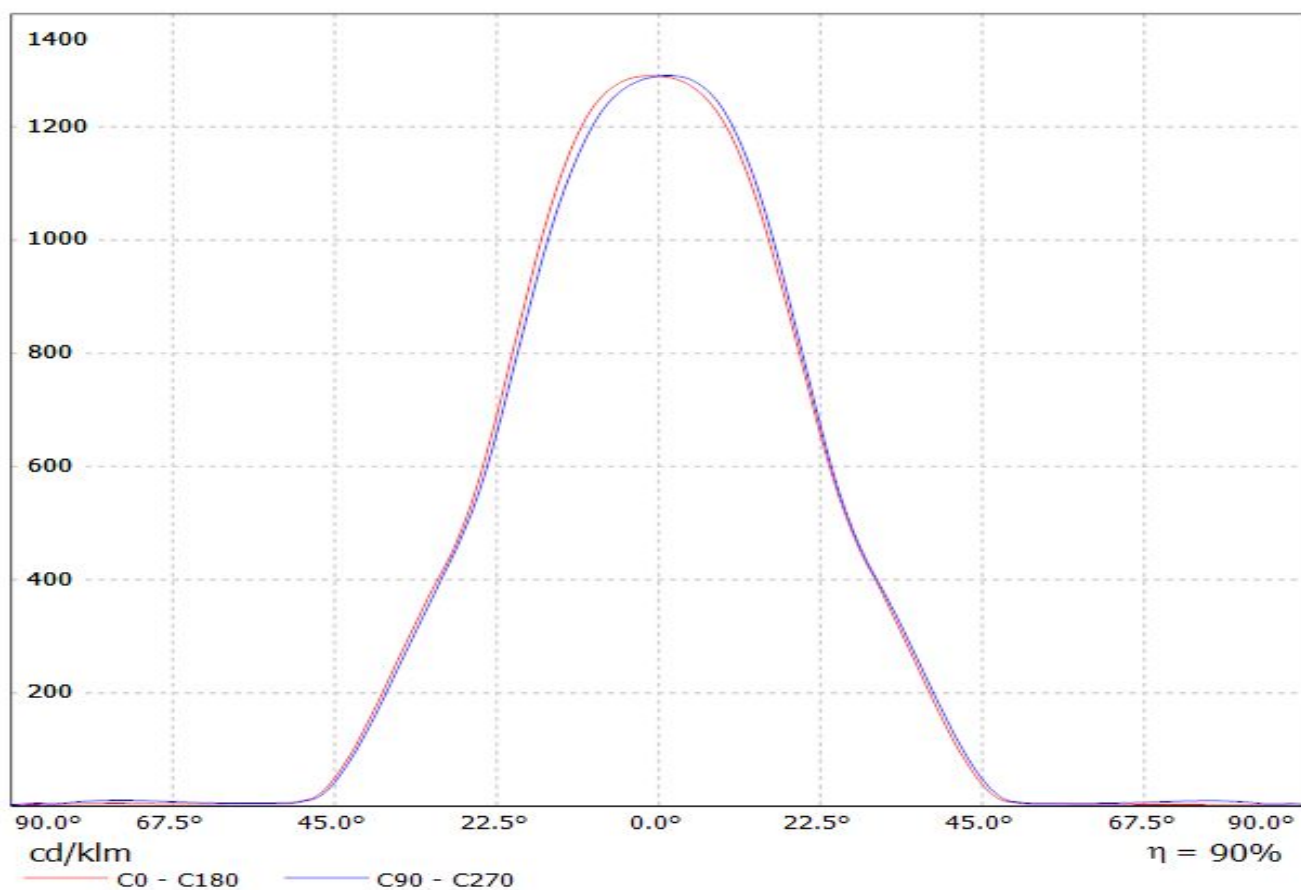

Luminaire: LEDiL Oy CN13923_MIRELLA-50-W-PF-VERO13_(XENIO_13MM)
Lamps: 1 x XENIO_13MM_2066.26lm@?mA_P=23W_I=?A

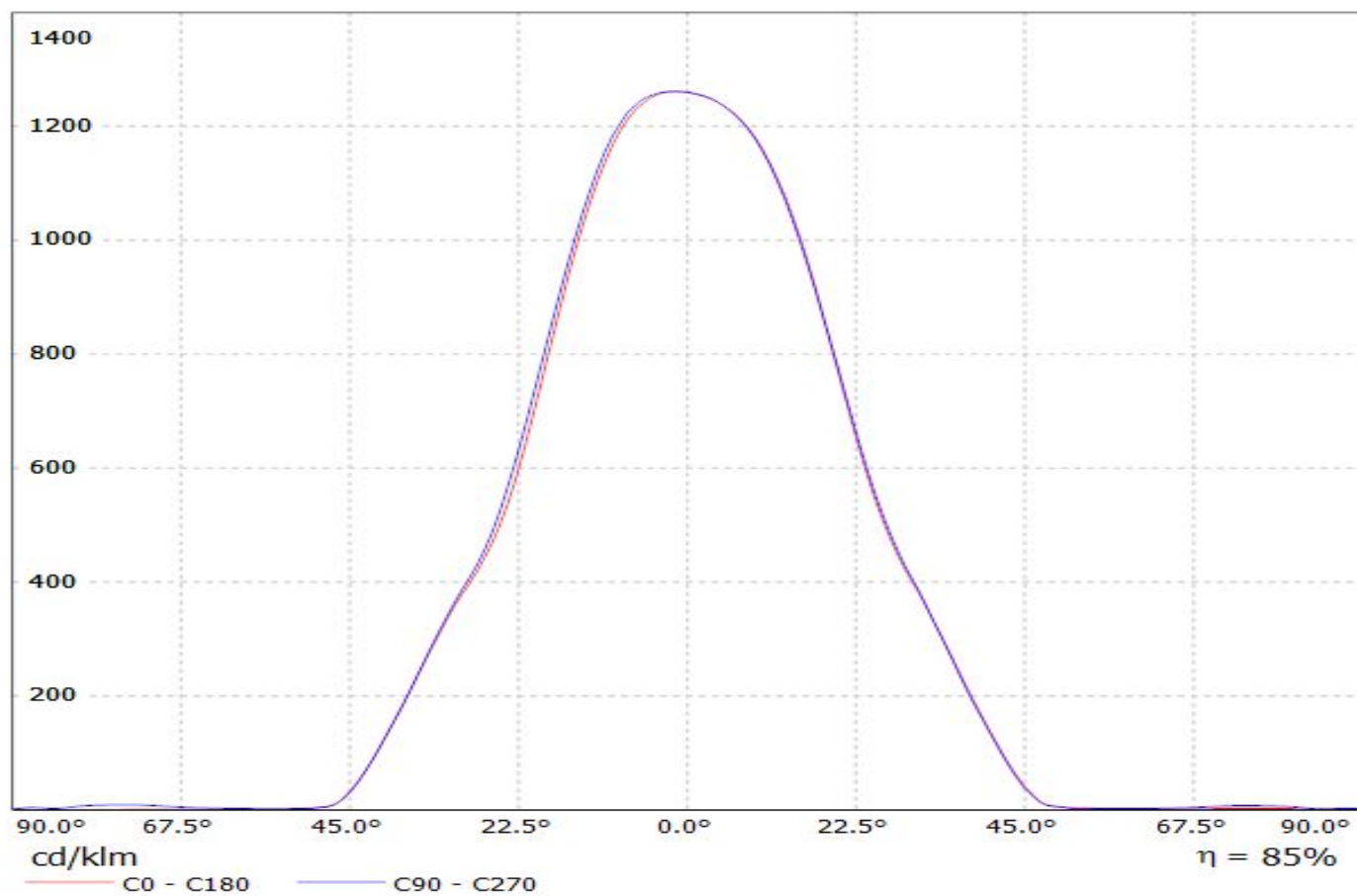

Ledil CN13923_MIRELLA-50-W-PF-VERO13_(CLU720) / LDC (Linear)

Luminaire: Ledil CN13923_MIRELLA-50-W-PF-VERO13_(CLU720)

Lamps: 1 x Citizen_(CLU720)_ (433_Typ_L1)_ (C13709)_ 1238.41lm@250mA_P=8.3W_I=0.25A

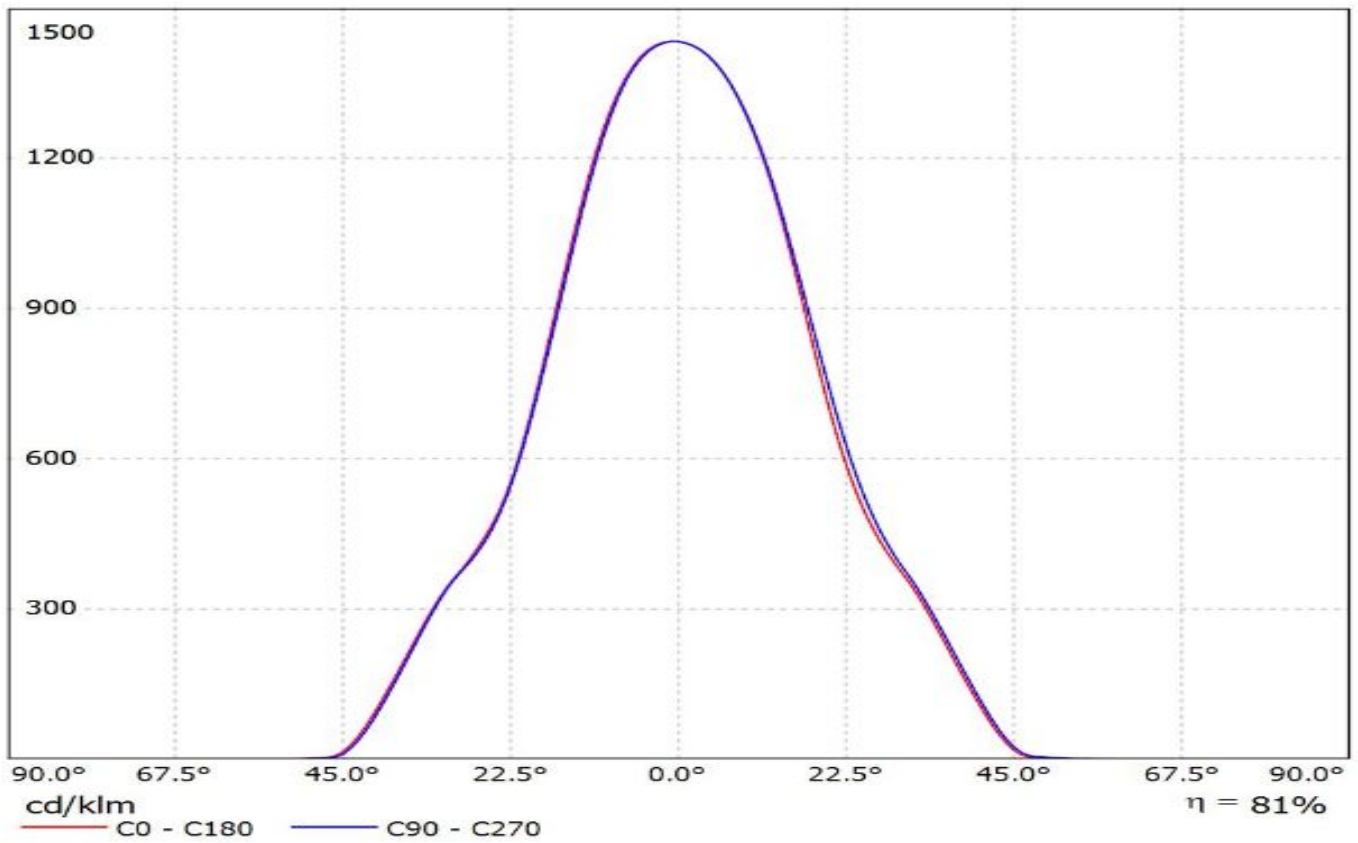

Luminaire: Ledil CN13923_MIRELLA-50-W-PF-VERO13_(CLU700) Citizen_CLU700_(CLU700-1002B8-273M2G1)_ (434_Typ_L1)_ (C13709_PF-SOCKET-VERO13-18)_ 389.152lm@100mA_P=2.8W_I=0.10A
Lamps: 1 x Citizen_CLU700_(CLU700-1002B8-273M2G1)_ (434_Typ_L1)_ (C13709_PF-SOCKET-VERO13-18)_ 389.152lm@100mA_P=2.8W_I=0.10A

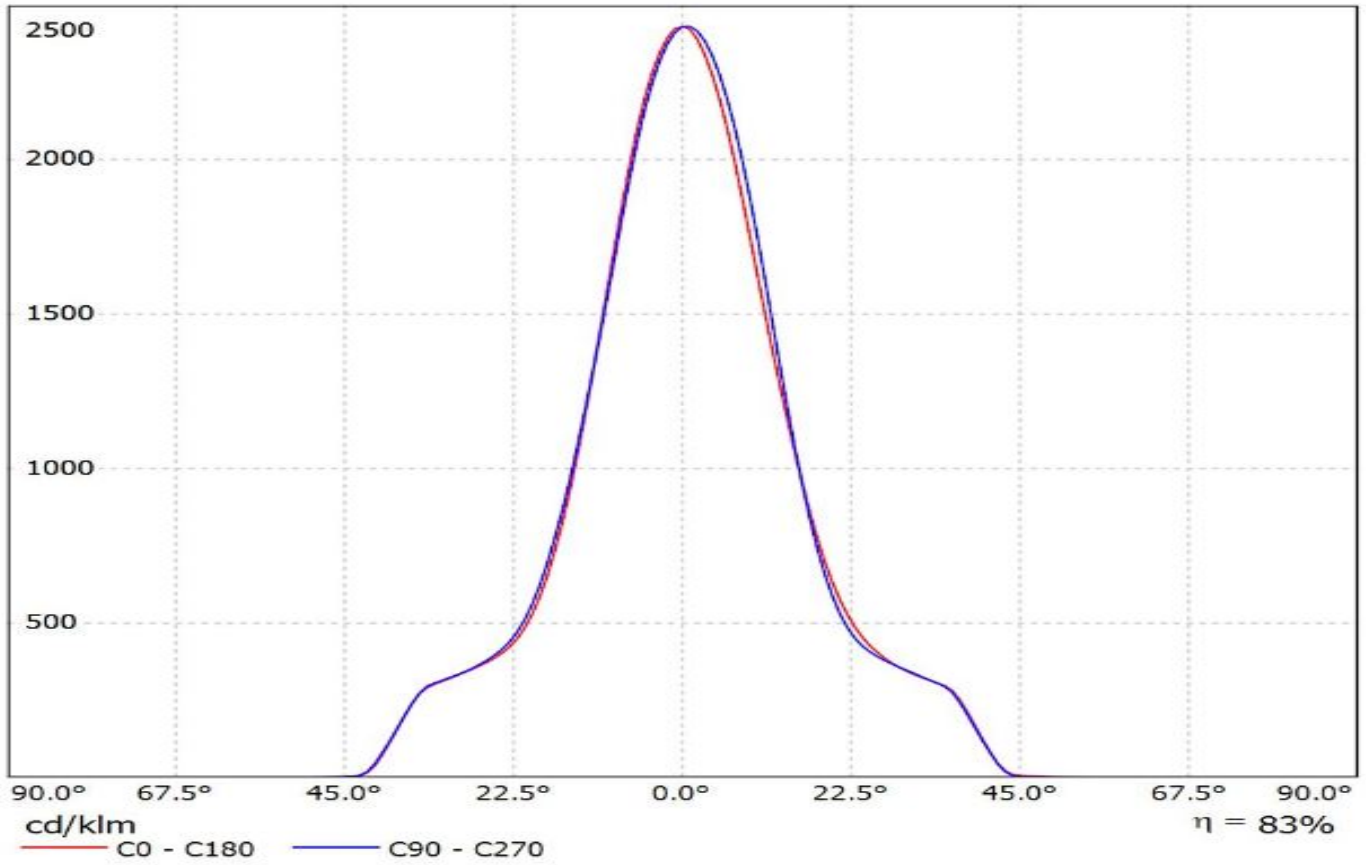

Luminaire: LEDiL Oy CN13923_MIRELLA-50-W-PF-VERO13_(CLU024) Citizen_CLU024_(434_Typ_L1)_(C13709)_1022.97lm@250mA_P=8.5066W_I=0.2499A
Lamps: 1 x Citizen_CLU024_(434_Typ_L1)_(C13709)_1022.97lm@250mA_P=8.5066W_I=0.2499A

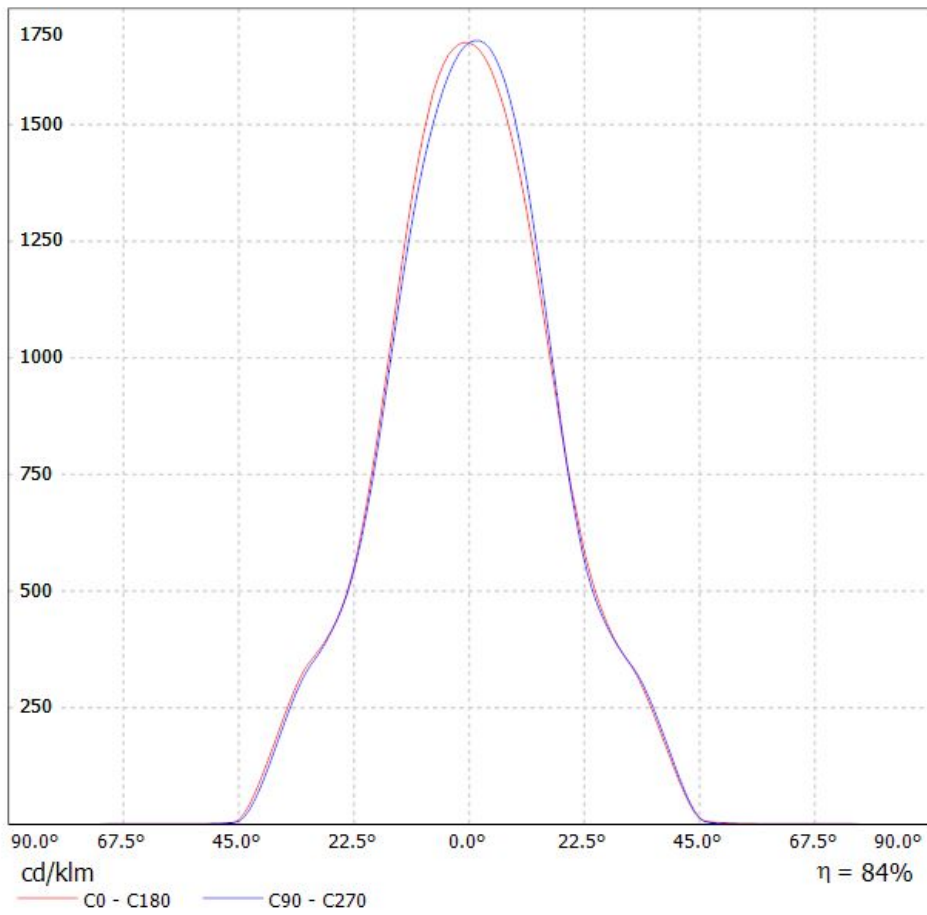

Luminaire: Ledil CN13923_MIRELLA-50-W-PF-VERO13_(CXA1520_(441_Typ_L1) CREE_CXA1520_(CXA1520-30F-N4-N0H-00001)_(441_Typ_L1)_(C13709_PF-SOCKET-VERO13-18)_1033.5lm@250mA_P=8.8W_I=0.25A
Lamps: 1 x CREE_CXA1520_(CXA1520-30F-N4-N0H-00001)_(441_Typ_L1)_(C13709_PF-SOCKET-VERO13-18)_1033.5lm@250mA_P=8.8W_I=0.25A

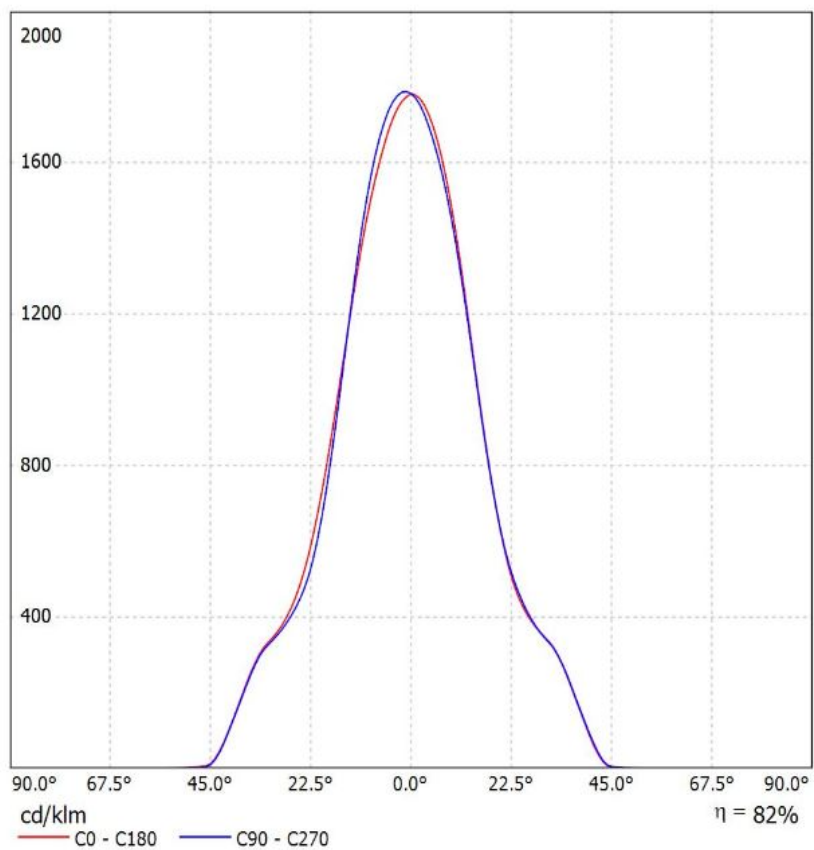

Luminaire: Ledil CN13923_MIRELLA-50-W-PF-VERO13_(CoB_1203)
Lamps: 1 x Luxeon_CoB_1203_(438 Typ L1)_1054.48lm@250mA_P=0.7_I=0.25A

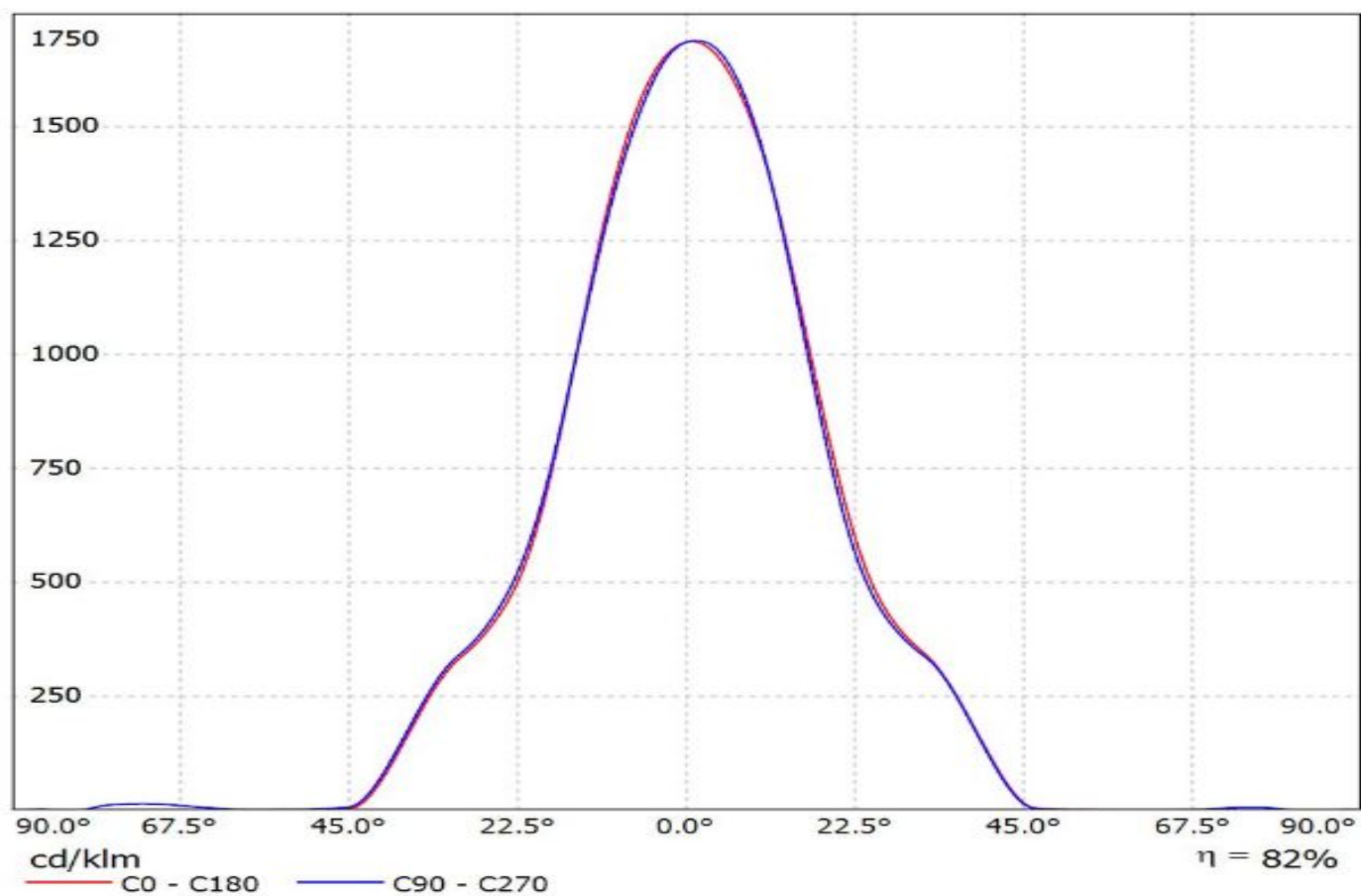

Luminaire: LEDiL Oy CN13923_MIRELLA-50-W-PF-VERO13_(Luxeon_CoB_1202s)
Lamps: 1 x Luxeon_CoB_1202s_(452 Typ L1)_231.765lm@100mA_P=1.62683W_I=0.10A

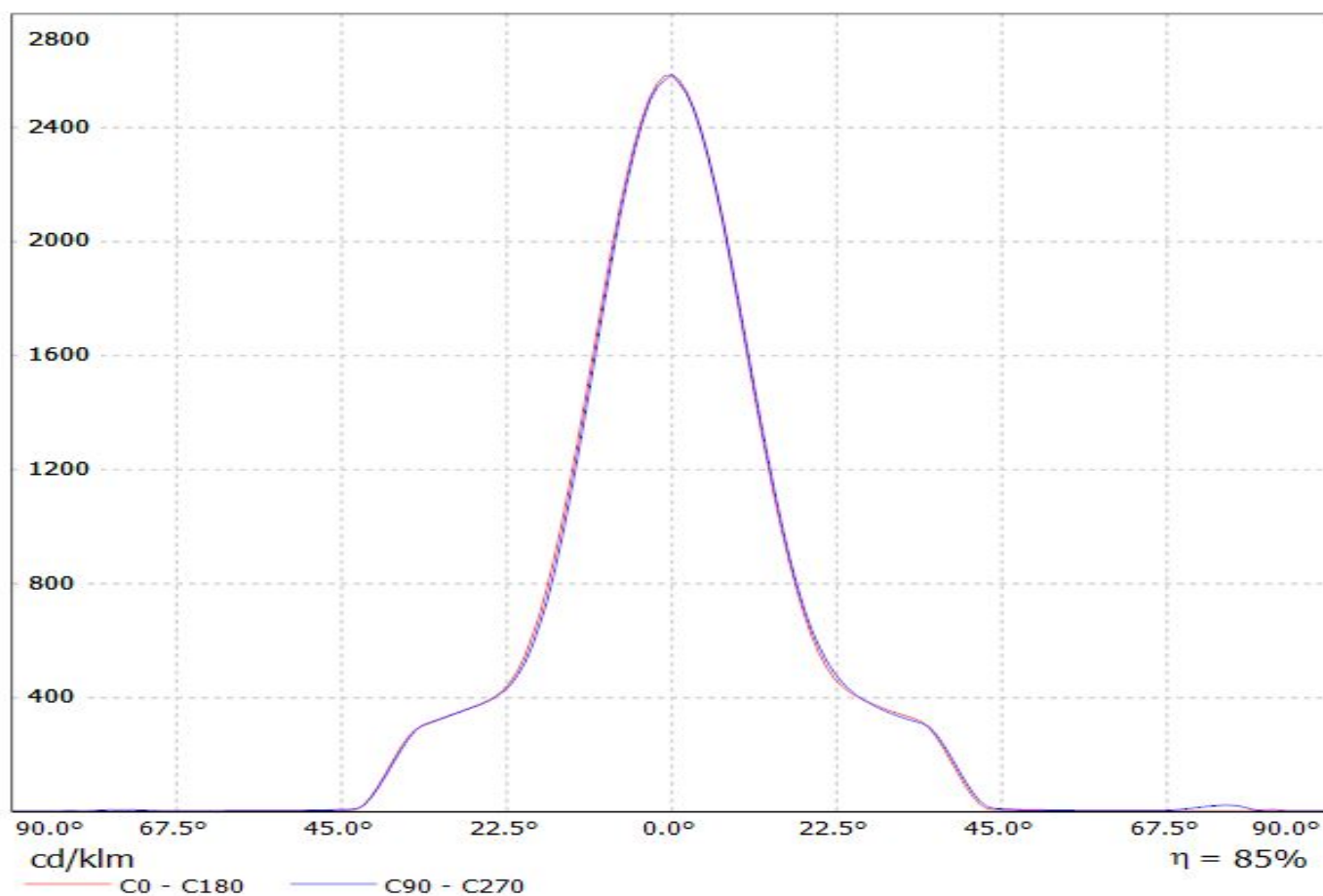

Luminaire: LEDiL Oy CN13923_MIRELLA-50-W-PF-VERO13_(NFCLL036B)

Lamps: 1 x Nichia NFCLL036B (sm403J1300R8000)_542.652lm@100mA_CCT=4000K_P=3.34084W_I=0.100A

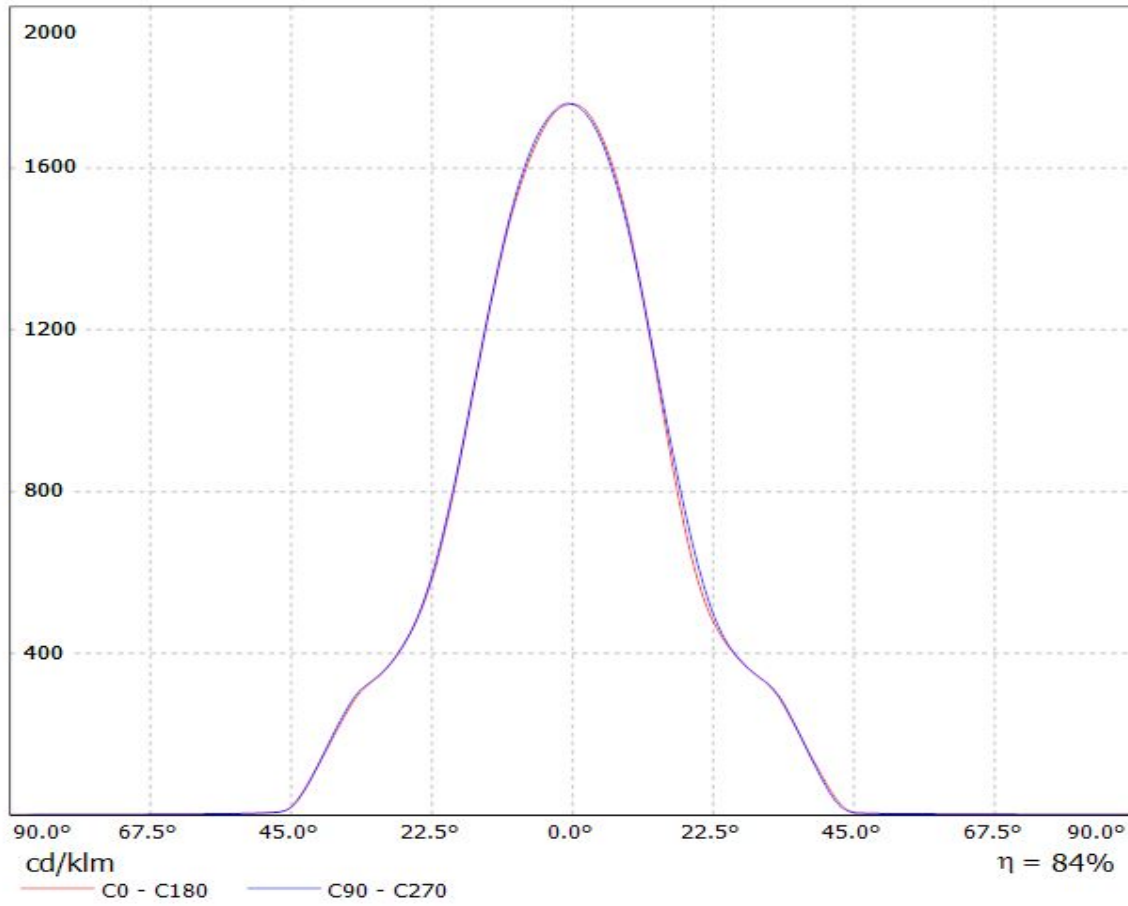

Luminaire: Ledil CN13923_MIRELLA-50-W-PF-VERO13_(NFCLL060B)

Lamps: 1 x Nichia_NFCLL060B_(438 Typ L1)_1355.59lm@250mA_P=8.5W_I=0.25A

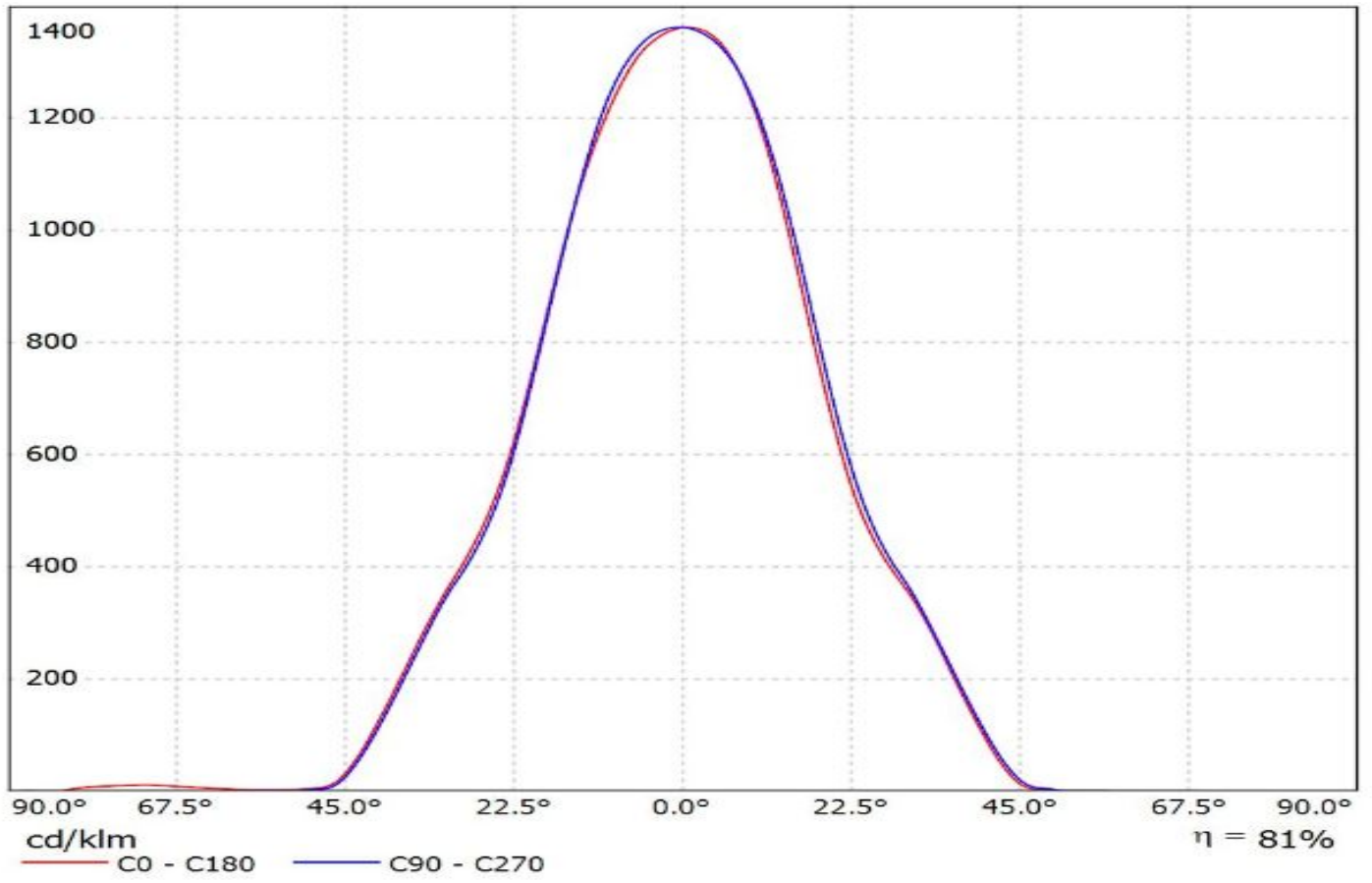

Luminaire: LEDiL Oy CN13923_MIRELLA-50-W-PF-VERO13_(Soleriq P9+461 Typ L1)
Lamps: 1 x Soleriq P9+461 Typ L1_881.86lm@250mA_P=6.96846W_I=250mA

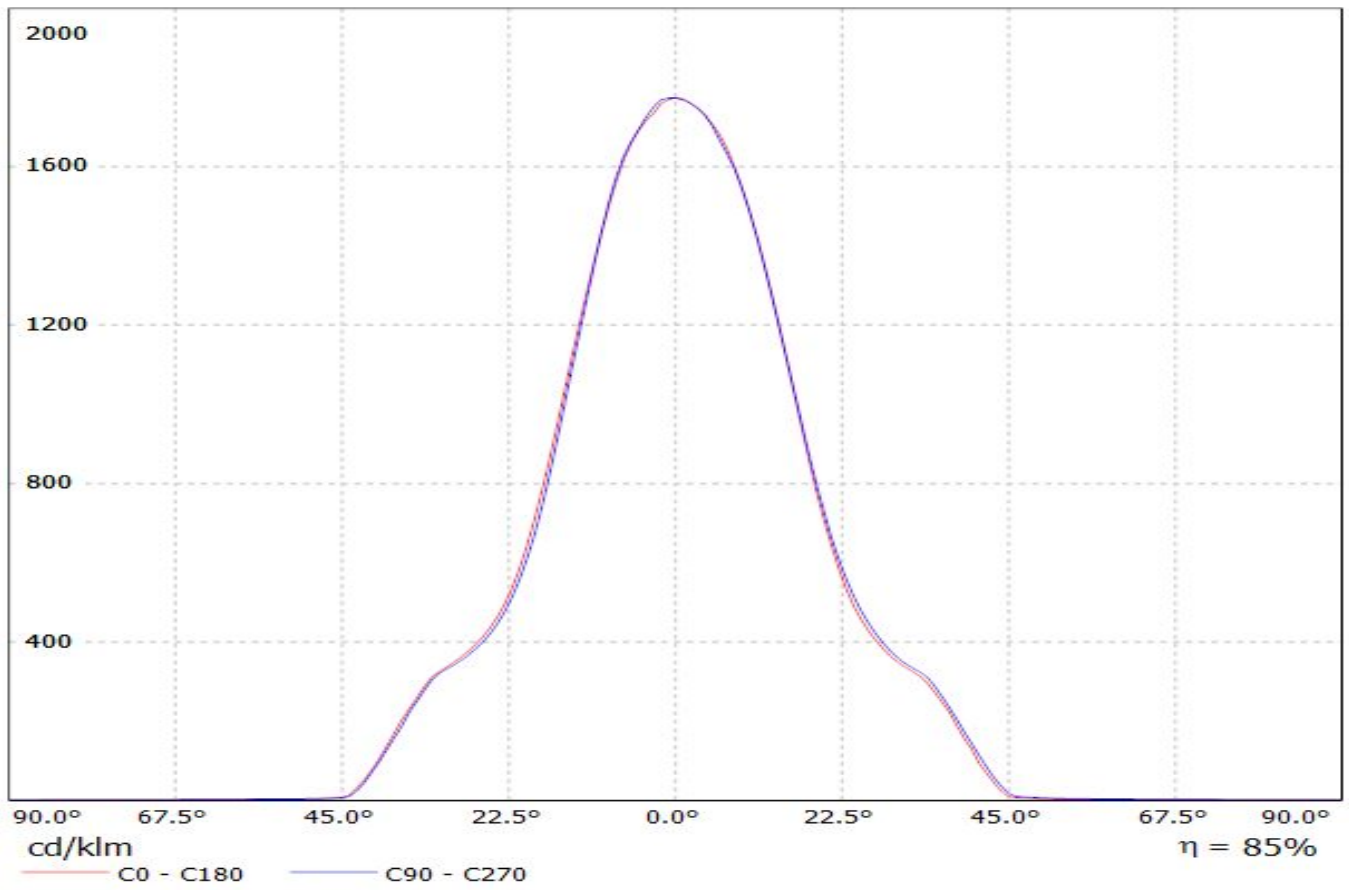

LEDiL Oy CN13923_MIRELLA-50-W-PF-VERO13_(Soleriq_P6) / LDC (Linear)

Luminaire: LEDiL Oy CN13923_MIRELLA-50-W-PF-VERO13_(Soleriq_P6)

Lamps: 1 x Osram_Soleriq_P6_(446 Typ L1)_464.246lm@250mA_P=6.28598W_I=0.25A

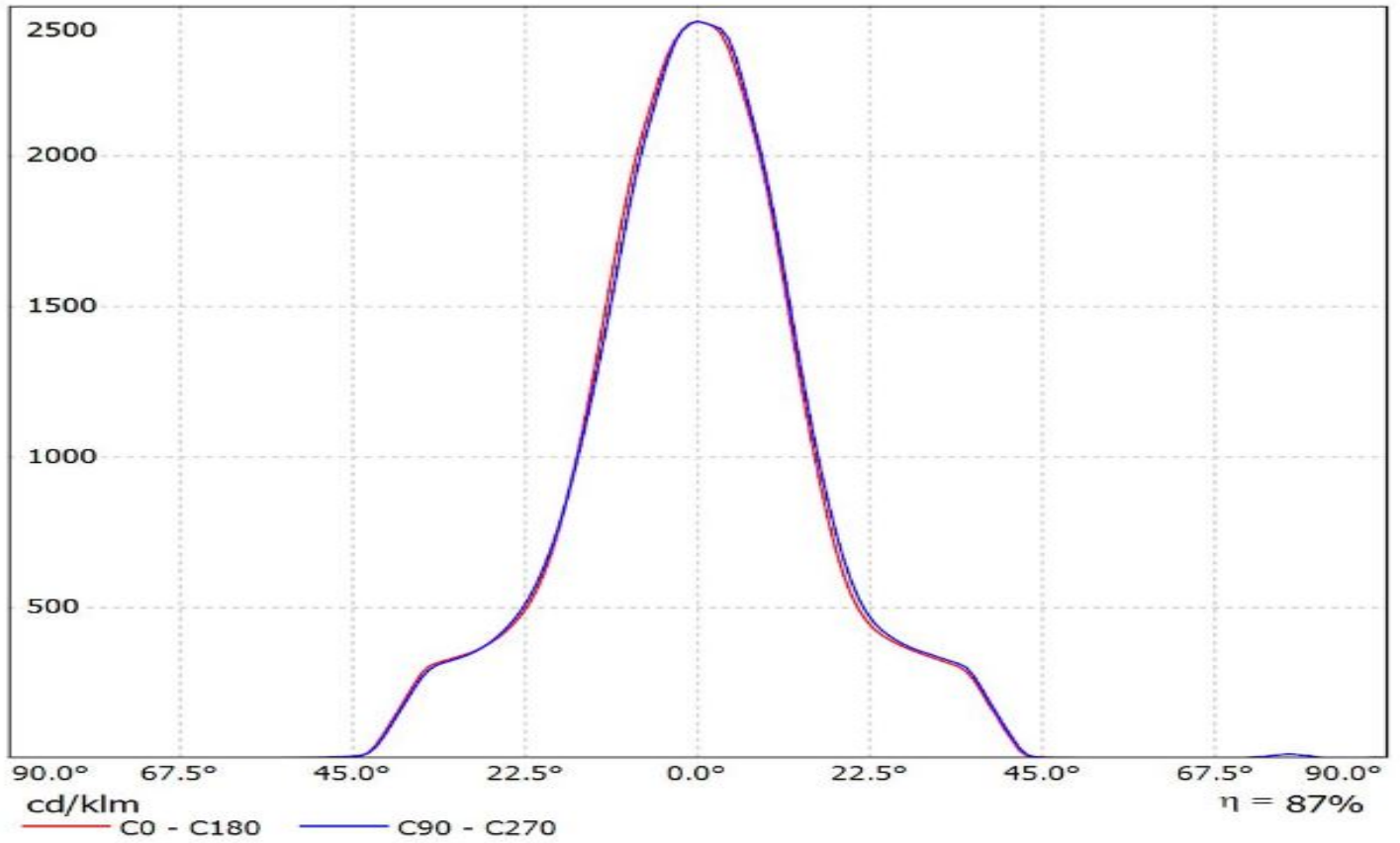

Luminaire: Ledil Oy CN13923_MIRELLA-50-W-PF-VERO13_(Soleriq_S9)_SIMULATED
Lamps: 1 x Osram Soleriq S9 (GW KAFJB3.EM)

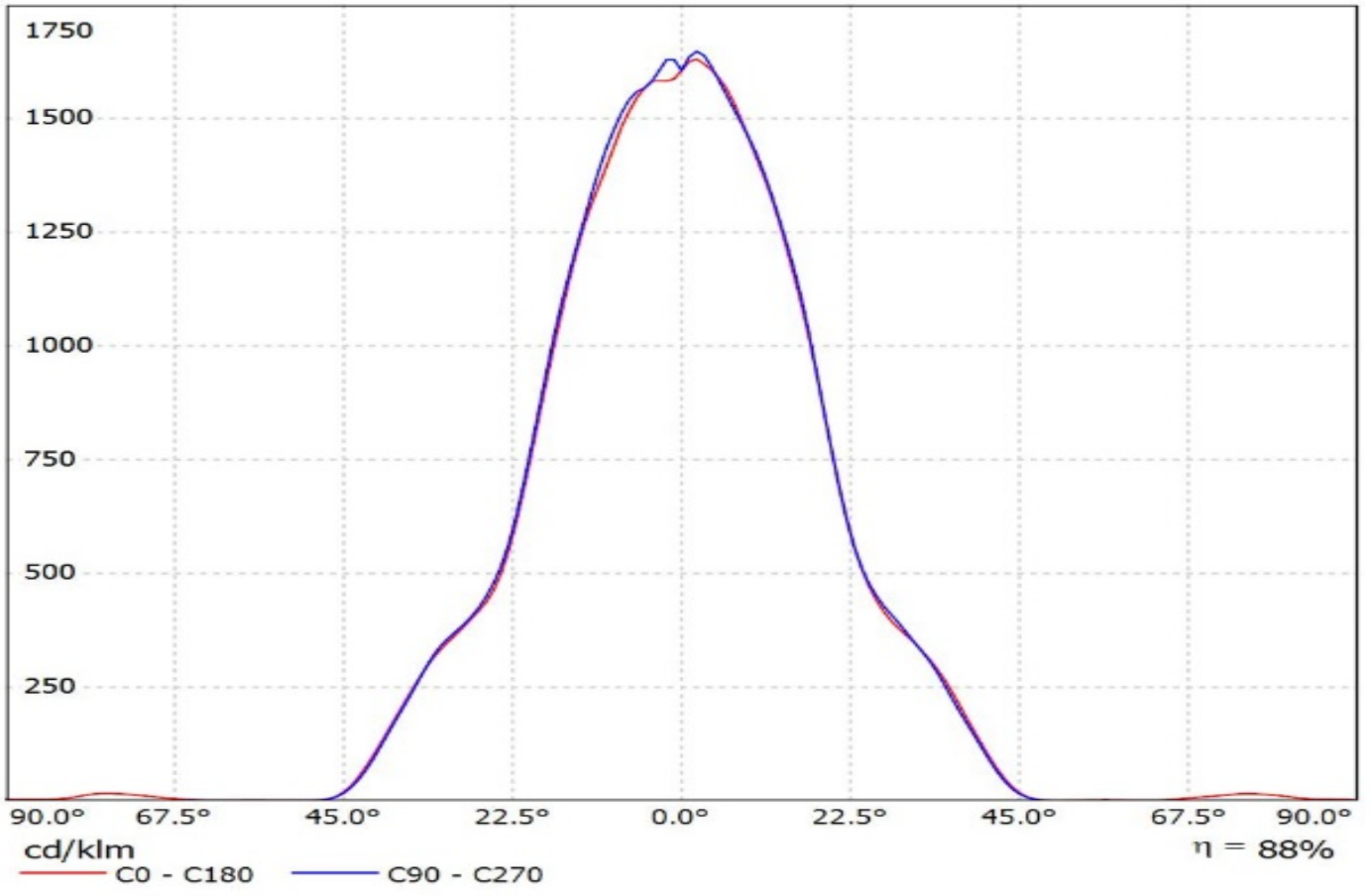

Luminaire: Ledil Oy CN13923_MIRELLA-50-W-PF-VERO13_(LC010C)_(479_type_L1)_SIMULATED
Lamps: 1 x Samsung LC010C + Bender & Wirth 479 Type L1

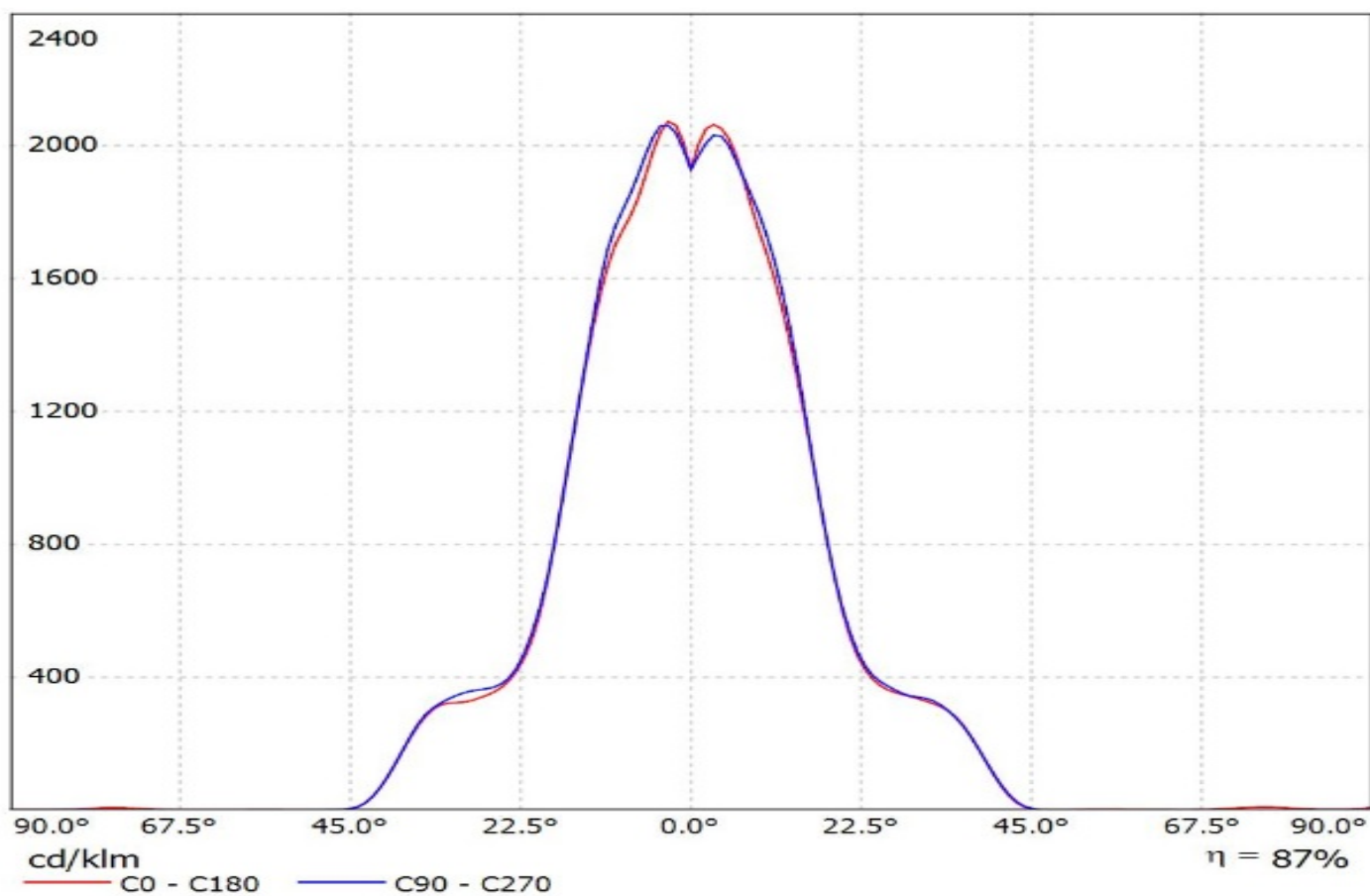

Luminaire: Ledil Oy CN13923_MIRELLA-50-W-PF-VERO13_(LC020C)_(479_type_L1)_SIMULATED
Lamps: 1 x Samsung LC020C + Bender & Wirth 479 Type L1

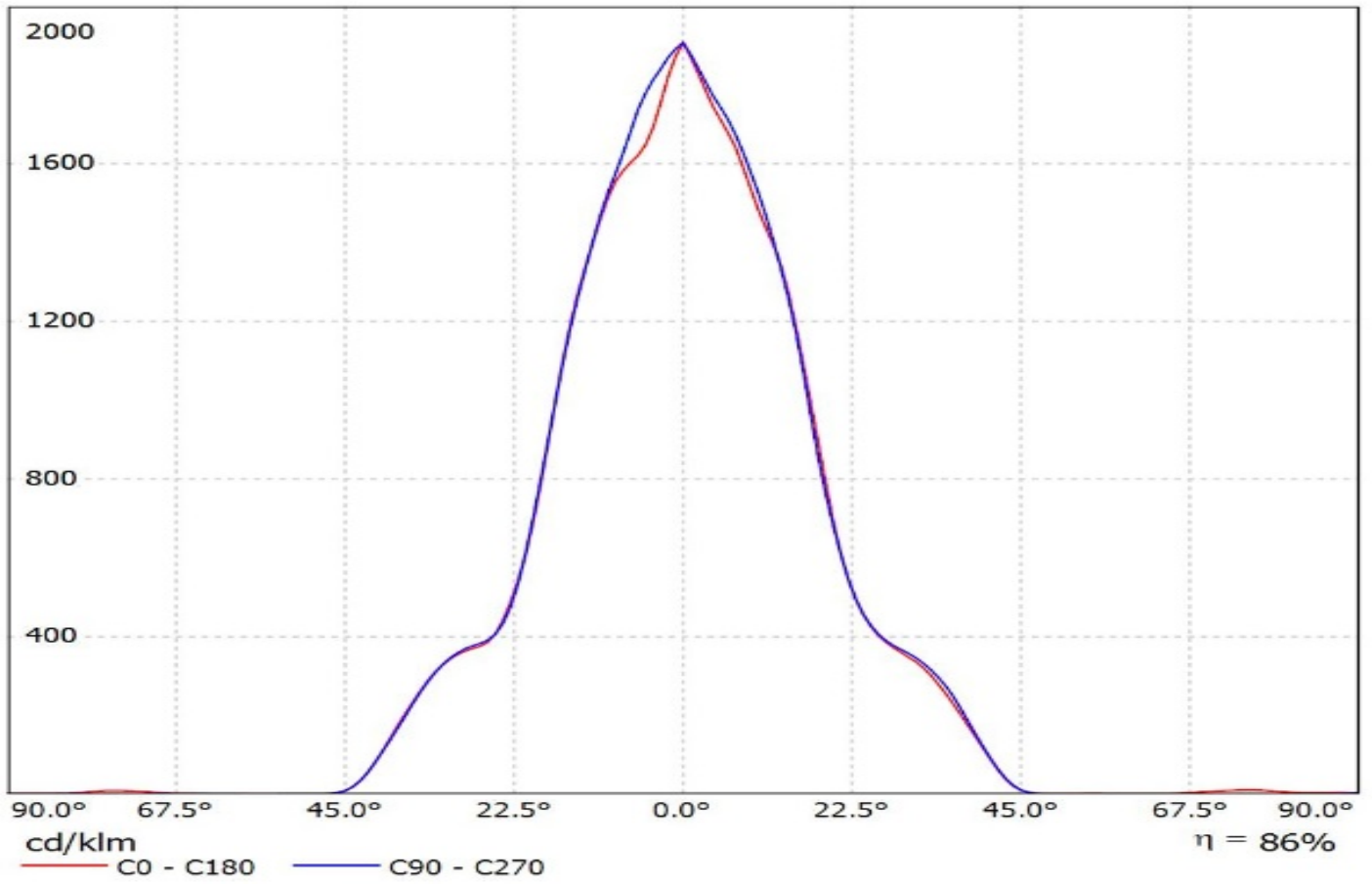

Luminaire: Ledil Oy CN13923_MIRELLA-50-W-PF-VERO13_(LC040C)_(480_type_L1)_SIMULATED
Lamps: 1 x Samsung LC040C + Bender & Wirth 480 Type L1

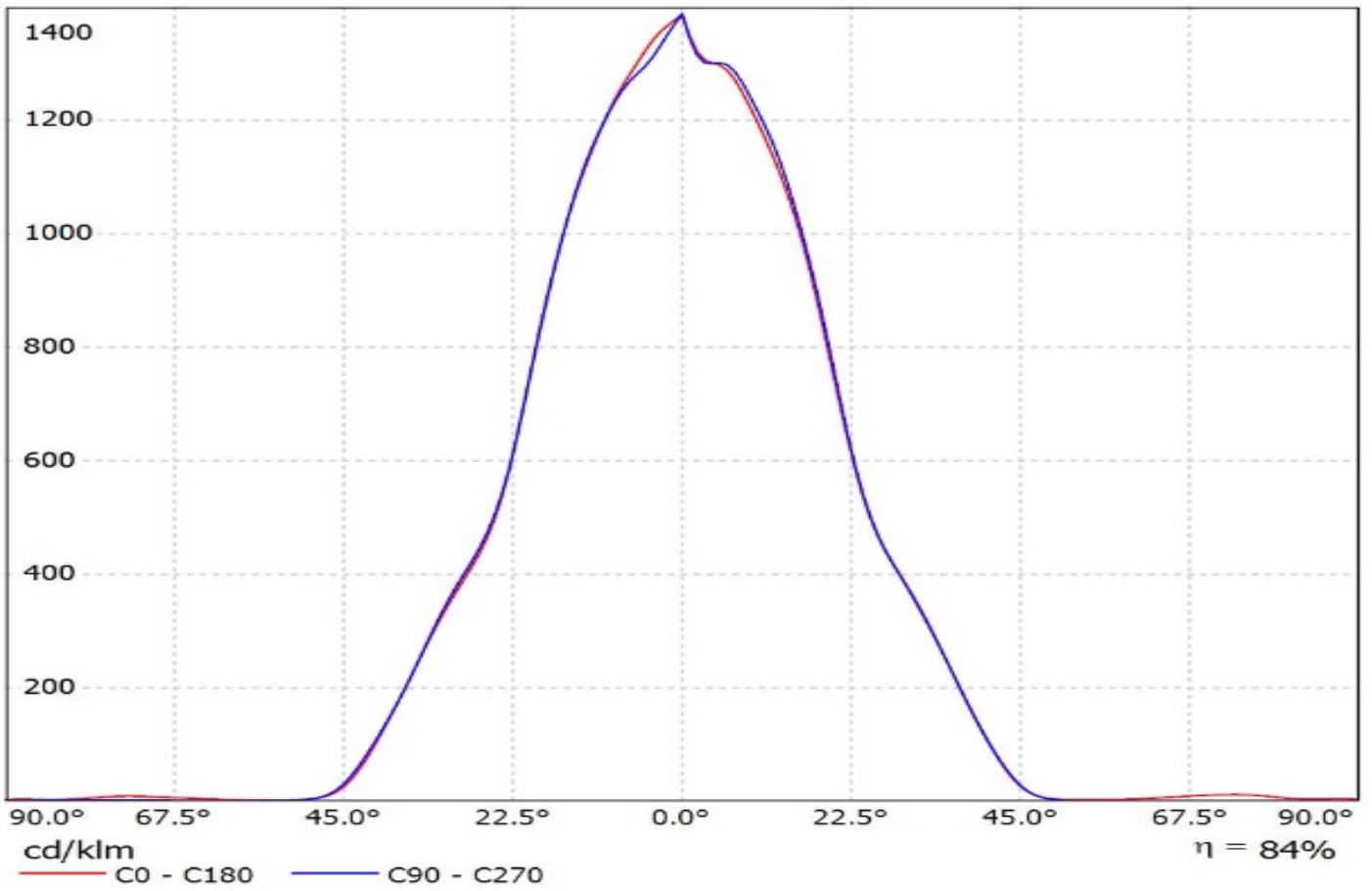

Luminaire: LEDiL Oy C13087_MIRELLA-50-W-PF Eff.89.9%

Lamps: 1 x Bridgelux_VERO13_(BXRC-30E2000C)_989.57lm@250mA_P=7.48526W_I=249.8mA

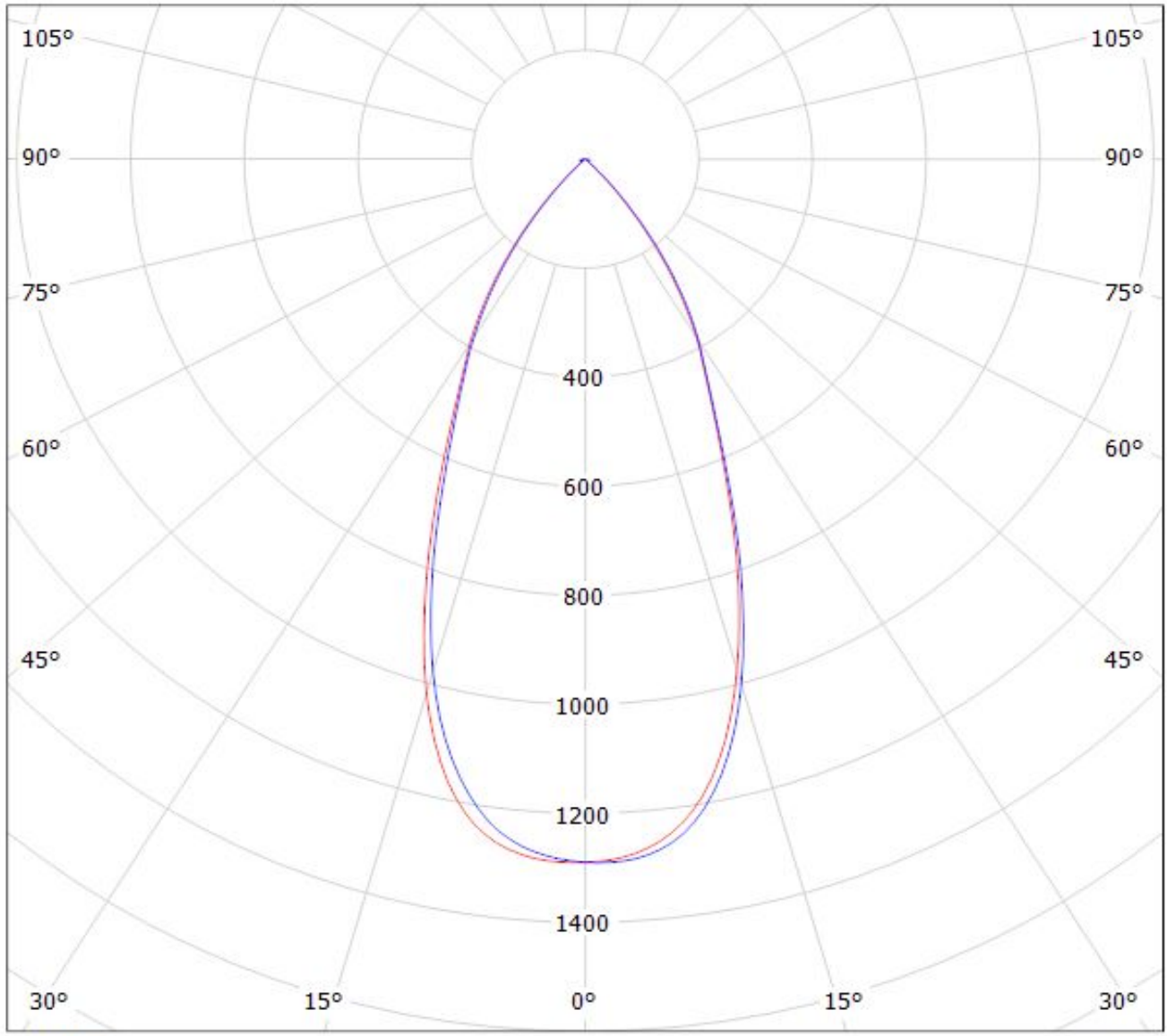

cd/klm

— C0 - C180

— C90 - C270

$\eta = 90\%$

Luminaire: LEDiL Oy CN13923_MIRELLA-50-W-PF-VERO13_(XENIO_13MM)
Lamps: 1 x XENIO_13MM_2066.26lm@?mA_P=23W_I=?A

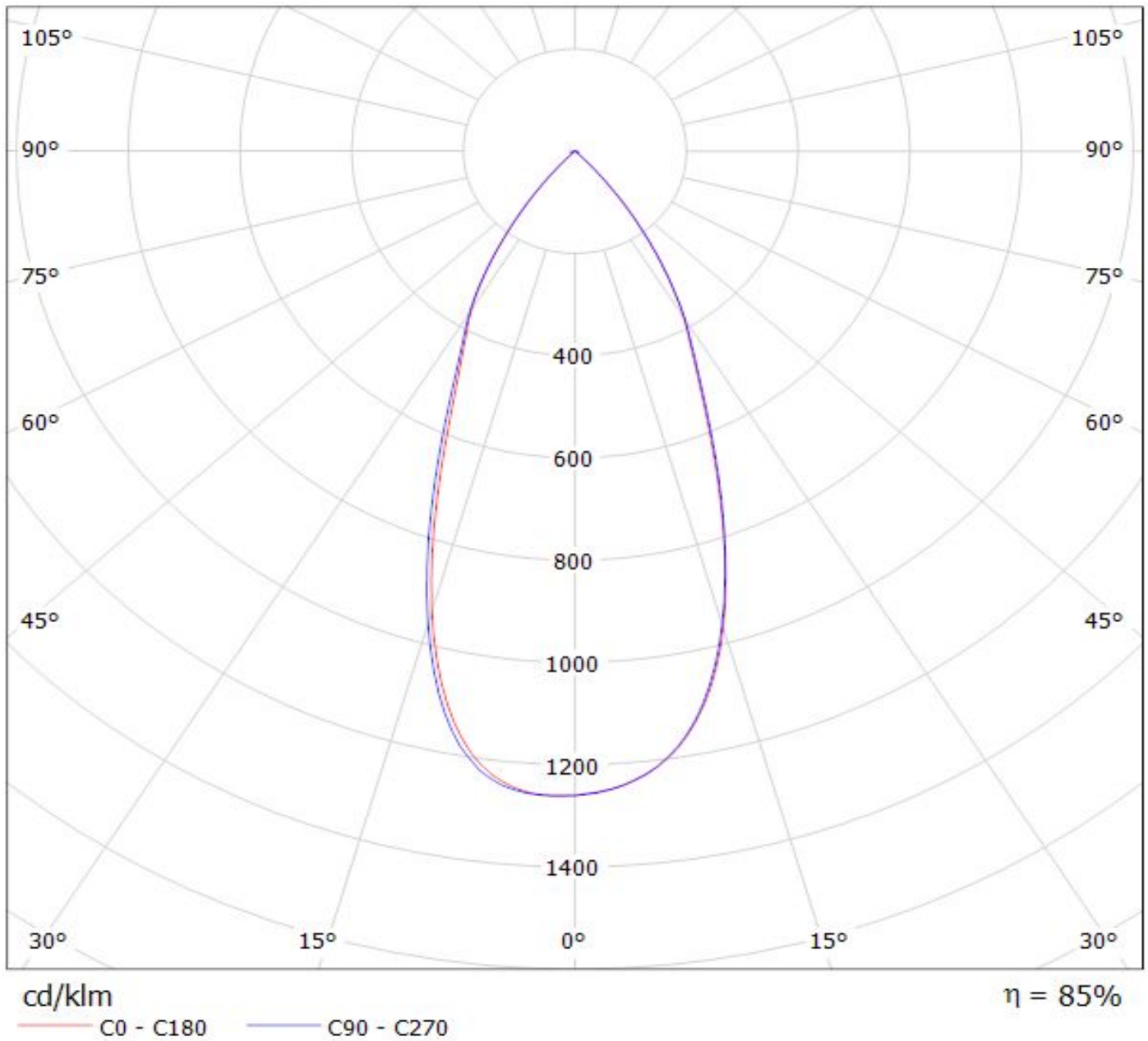

Ledil CN13923_MIRELLA-50-W-PF-VERO13_(CLU720) / LDC (Polar)

Luminaire: Ledil CN13923_MIRELLA-50-W-PF-VERO13_(CLU720)

Lamps: 1 x Citizen_(CLU720)_ (433_Typ_L1)_ (C13709)_ 1238.41lm@250mA_P=8.3W_I=0.25A

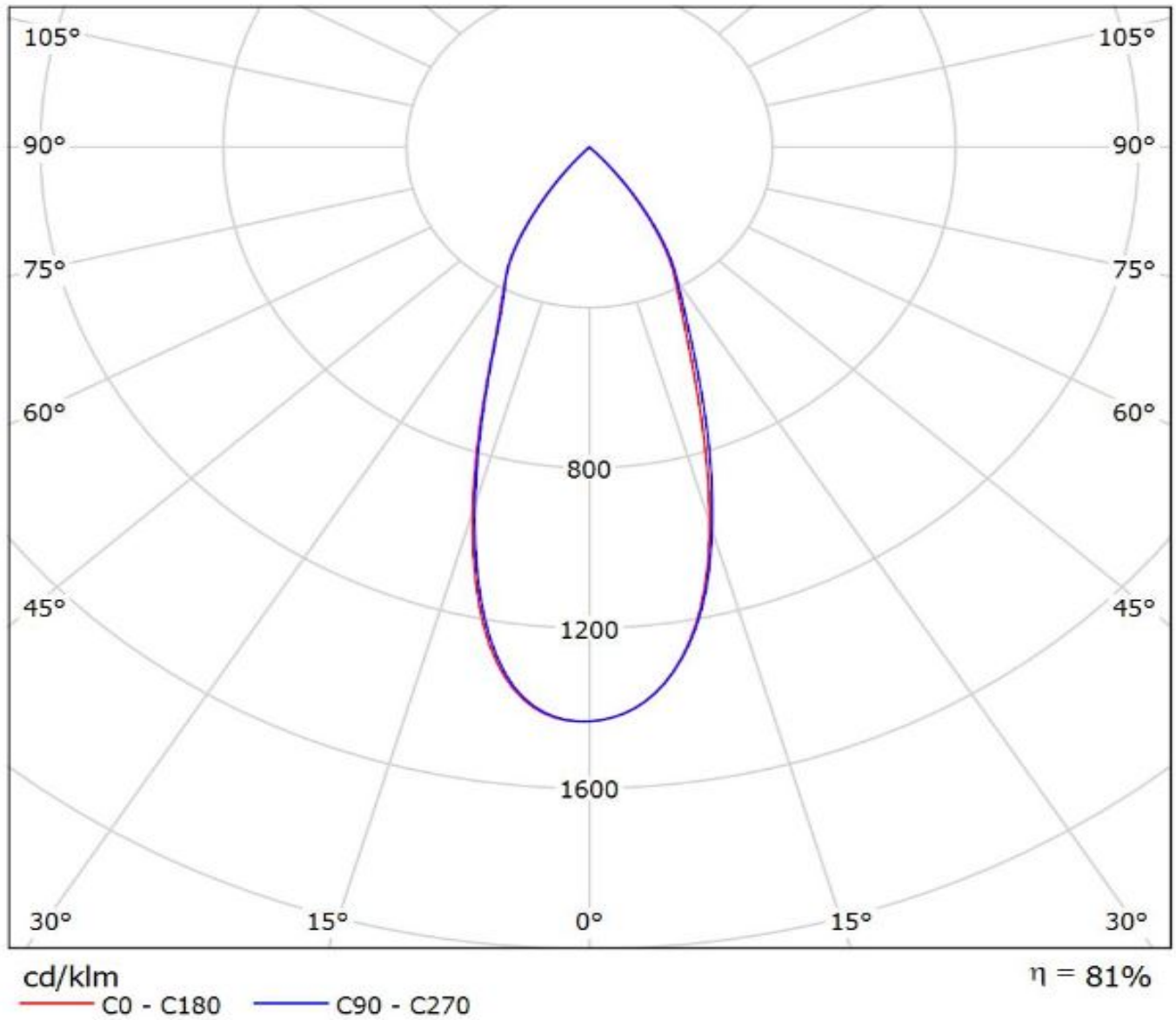

Luminaire: Ledil CN13923_MIRELLA-50-W-PF-VERO13_(CLU700) Citizen_CLU700_(CLU700-1002B8-273M2G1)_ (434_Typ_L1)_ (C13709_PF-SOCKET-VERO13-18)_389.152lm@100mA_P=2.8W_I=0.10A
Lamps: 1 x Citizen_CLU700_(CLU700-1002B8-273M2G1)_ (434_Typ_L1)_ (C13709_PF-SOCKET-VERO13-18)_389.152lm@100mA_P=2.8W_I=0.10A

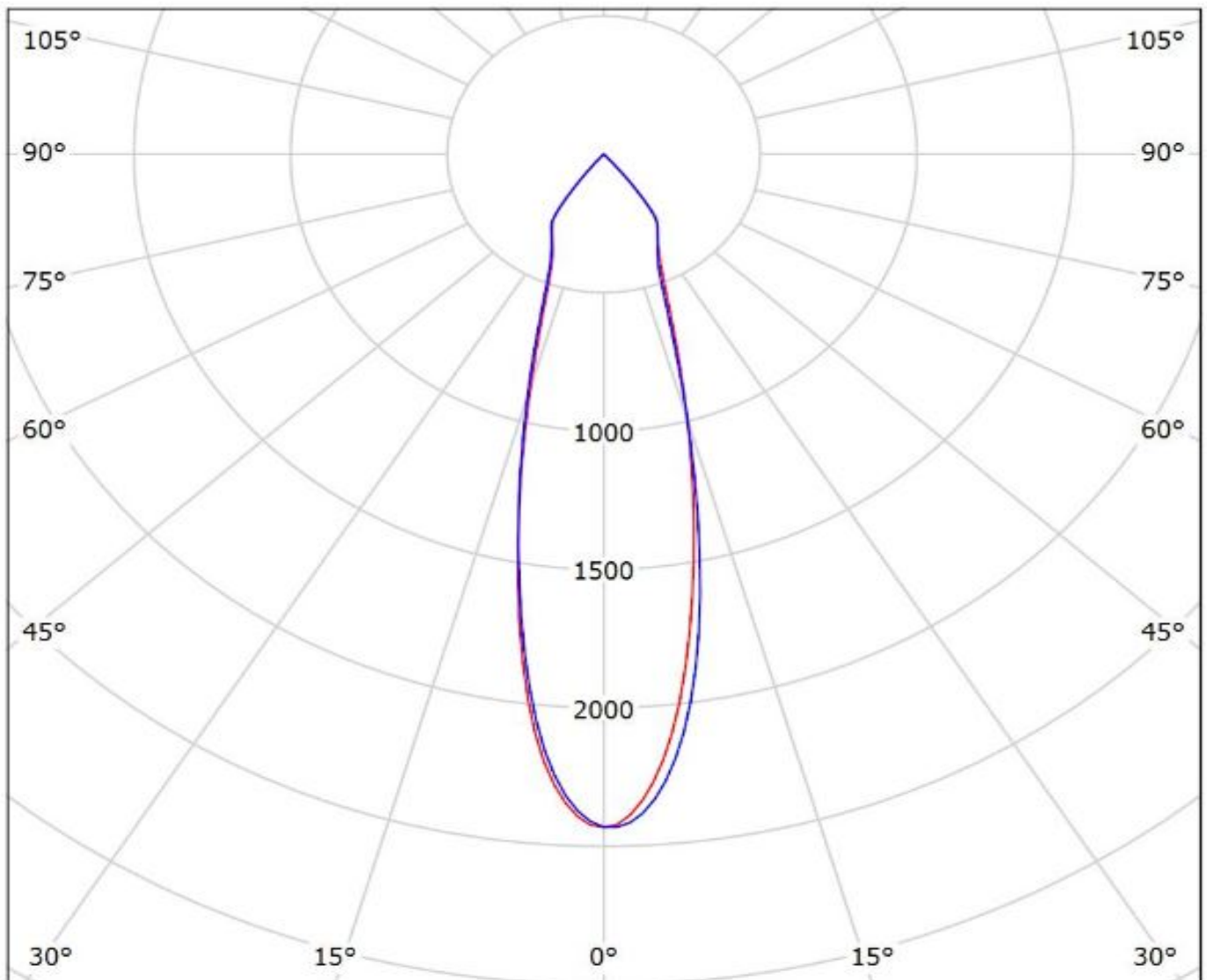

cd/klm

— C0 - C180 — C90 - C270

$\eta = 83\%$

Luminaire: LEDiL Oy CN13923_MIRELLA-50-W-PF-VERO13_(CLU024) Citizen_CLU024_(434_Typ_L1)_(C13709)_1022.97lm@250mA_P=8.5066W_l=0.2499A
Lamps: 1 x Citizen_CLU024_(434_Typ_L1)_(C13709)_1022.97lm@250mA_P=8.5066W_l=0.2499A

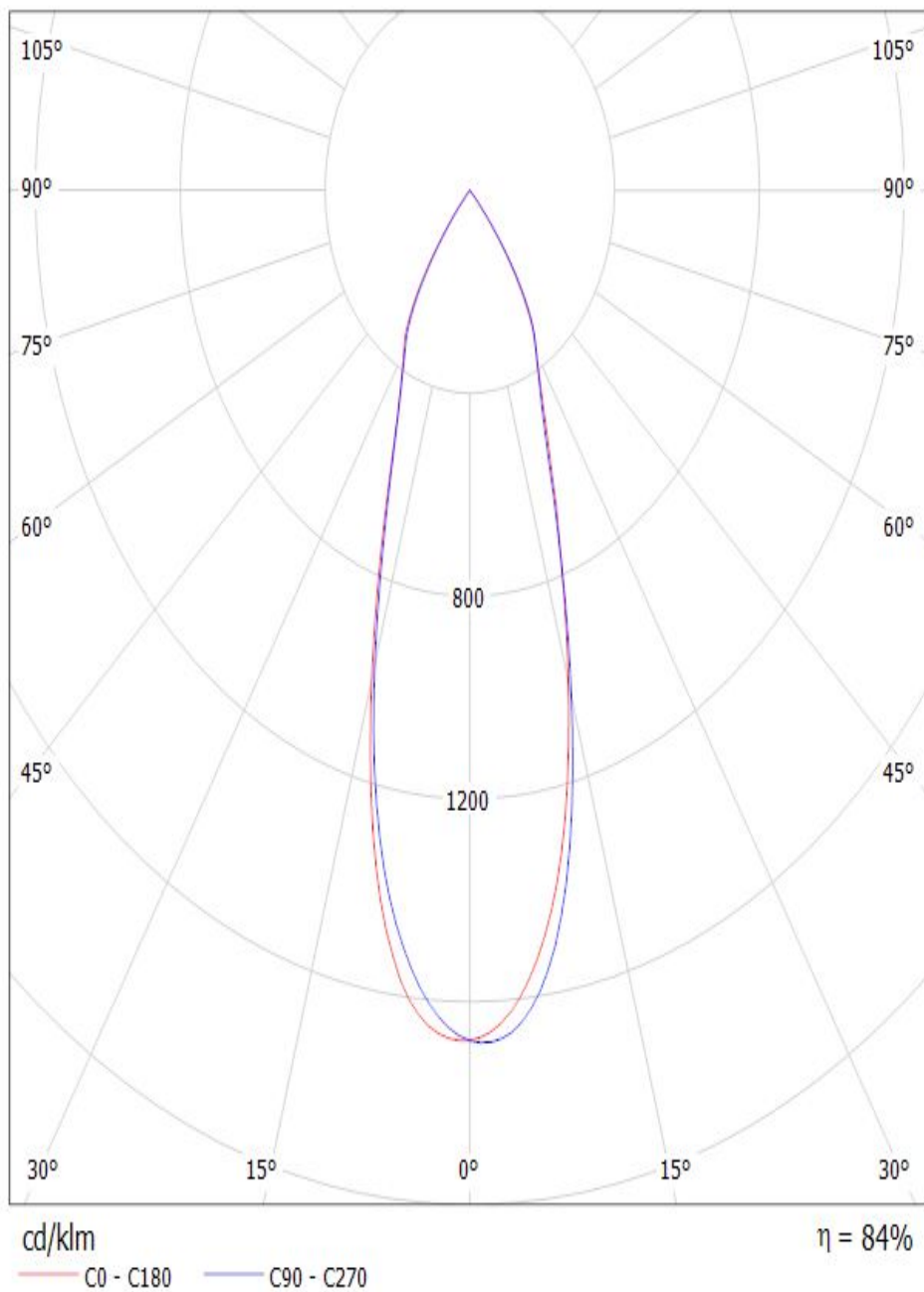

Luminaire: Ledil CN13923_MIRELLA-50-W-PF-VERO13_(CXA1520)_(441_Typ_L1) CREE_CXA1520_(CXA1520-30F-N4-N0H-00001)_(441_Typ_L1)_(C13709_PF-SOCKET-VERO13-18)_1033.5lm@250mA_P=8.8W_I=0.25A

Lamps: 1 x CREE_CXA1520_(CXA1520-30F-N4-N0H-00001)_(441_Typ_L1)_(C13709_PF-SOCKET-VERO13-18)_1033.5lm@250mA_P=8.8W_I=0.25A

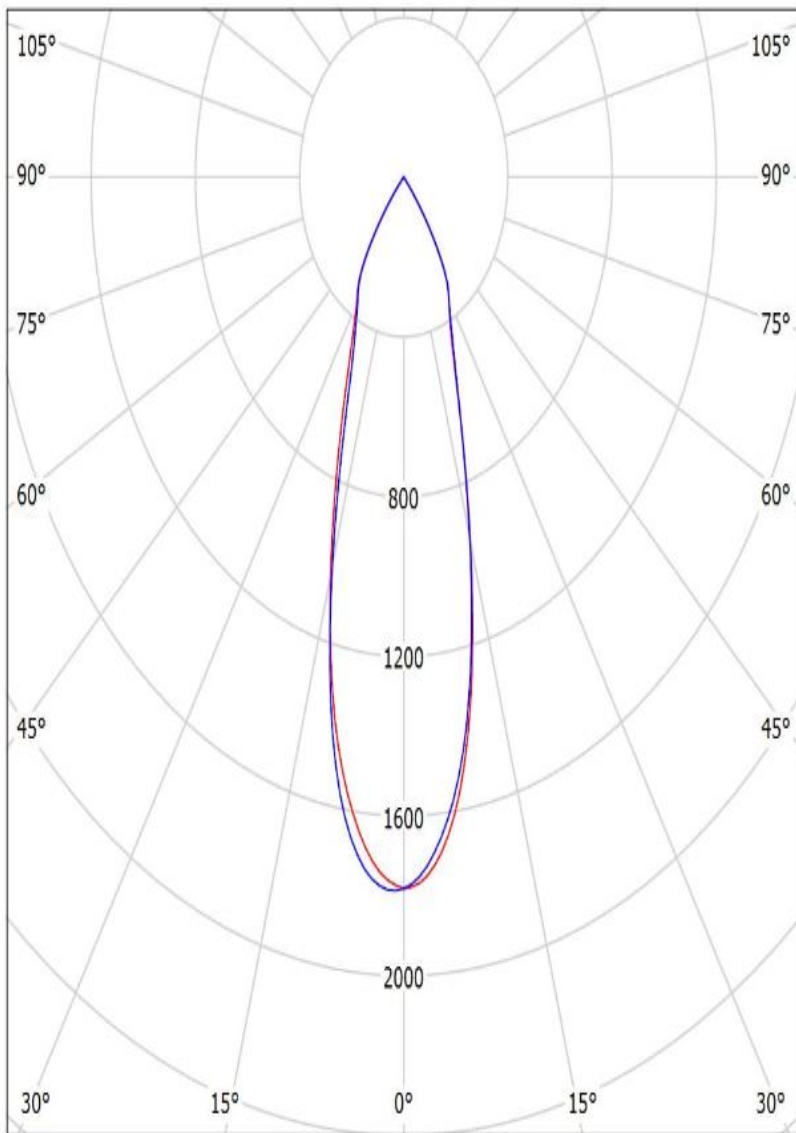

cd/klm

— C0 - C180 — C90 - C270

$\eta = 82\%$