



Chipsmall Limited consists of a professional team with an average of over 10 year of expertise in the distribution of electronic components. Based in Hongkong, we have already established firm and mutual-benefit business relationships with customers from,Europe,America and south Asia,supplying obsolete and hard-to-find components to meet their specific needs.

With the principle of “Quality Parts,Customers Priority,Honest Operation,and Considerate Service”,our business mainly focus on the distribution of electronic components. Line cards we deal with include Microchip,ALPS,ROHM,Xilinx,Pulse,ON,Everlight and Freescale. Main products comprise IC,Modules,Potentiometer,IC Socket,Relay,Connector.Our parts cover such applications as commercial,industrial, and automotives areas.

We are looking forward to setting up business relationship with you and hope to provide you with the best service and solution. Let us make a better world for our industry!



Contact us

Tel: +86-755-8981 8866 Fax: +86-755-8427 6832

Email & Skype: info@chipsmall.com Web: www.chipsmall.com

Address: A1208, Overseas Decoration Building, #122 Zhenhua RD., Futian, Shenzhen, China



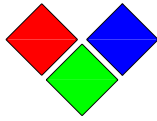

深圳市昱申科技有限公司

CHINA YOUNG SUN LED TECHNOLOGY CO., LTD.

TEL: (86) 755-28079401 28079402 28079403 28079404 28079405
FAX: (86) 755-28079407 E-mail: info@100LED.com Web: www.100LED.com

Model No.: YSD-439AR6B-35

Applications:

- . Moving Message Display
- . Full Color Display
- . Banking Board
- . Score Boards
- . Digital Display

LED Chip Absolute Maximum Ratings: (Ta= 25 °C)

Parameter	Symbol	Red	Unit
Forward current	I _F	20	mA
Peak forward current (Duty Cycle = $\frac{1}{10}$, 10KHz)	I _{PF}	30	mA
Reverse voltage (V _R = 5V)	I _R	10	μA
Operating temp	T _{OPR}	-25 - 85	°C
Storage temp	T _{STG}	-30 - 85	°C
Peak Emission Wavelength	λ _{PH}	645	nm

* Soldering Bath: not more than 5 seconds @260 °C. The bottom ends of the plastic reflector should be at least 2mm above the solder surface

Soldering Iron: not more than 3 seconds @300 °C under 30W

LED Chip Typical Electrical & Optical Characteristics: (Ta= 25 °C)

ITEMS	Symbol	Condition	Min.	Typ.	Max.	Unit
Forward Voltage	V _F	I _F = 20mA	2.0	2.1	2.2	V
Luminous Intensity	I _v	I _F = 20mA	50	55	60	mcd
Wavelength	Δλ	I _F = 20mA	640	642	645	nm
Light Degradation after 1000 hours			-4.68% ~ -8.27%			

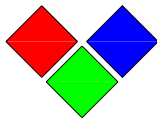

深圳市昱申科技有限公司

CHINA YOUNG SUN LED TECHNOLOGY CO., LTD.

TEL: (86) 755-28079401 28079402 28079403 28079404 28079405

FAX: (86) 755-28079407 E-mail: info@100LED.com Web: www.100LED.com

Mechanical Dimensions:

- . All dimension are in mm, tolerance is $\pm 0.2\text{mm}$ unless otherwise noted
- . An epoxy meniscus may extend about 1.5mm down the leads.

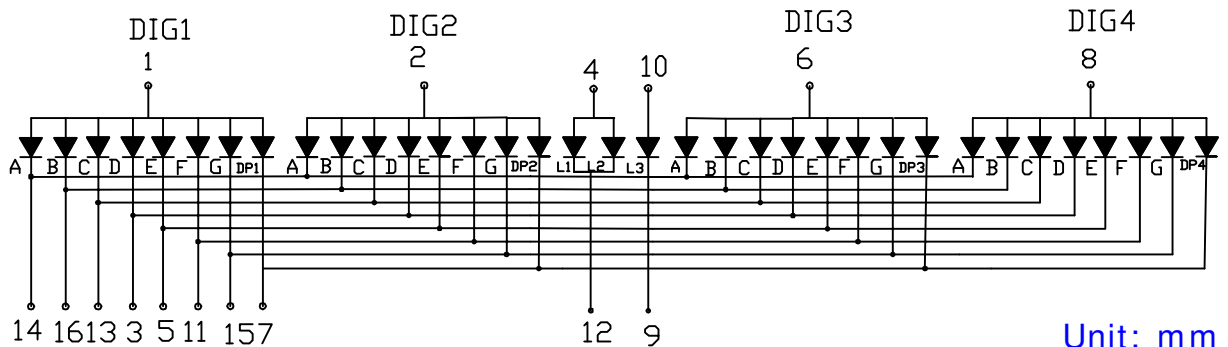
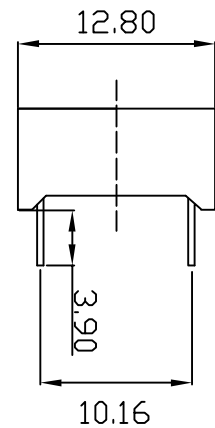
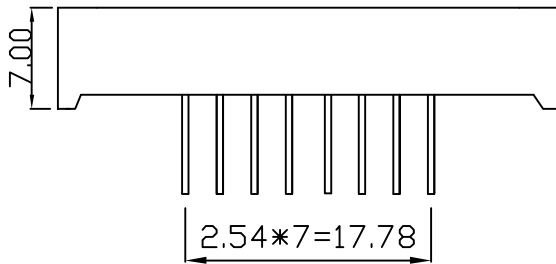
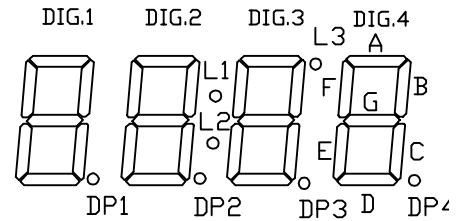
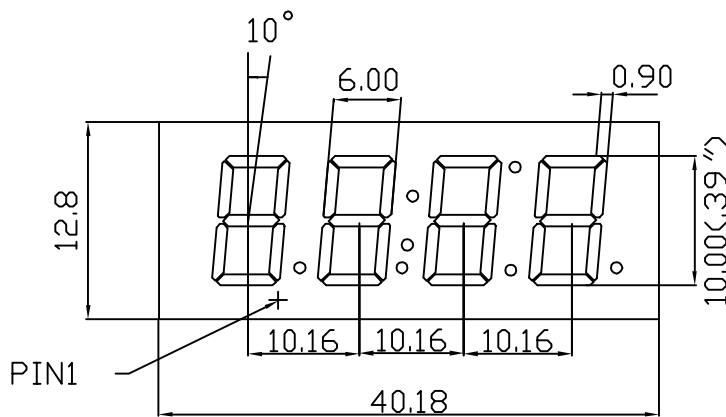

Unit: mm

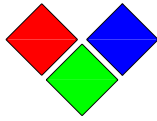

深圳市昱申科技有限公司

CHINA YOUNG SUN LED TECHNOLOGY CO., LTD.

TEL: (86) 755-28079401 28079402 28079403 28079404 28079405

FAX: (86) 755-28079407 E-mail: info@100LED.com Web: www.100LED.com

Code System:

YSM-439AXXA-35

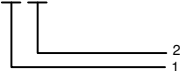

1. Color:

R: Red A: Amber K: Kelly Y: Yellow
G: Green C: Cyan P: Purple W: White

2. Wavelength or Color Temperature Range:

R1: 620-625nm	K1: 565-570nm	C1: 495-497.5nm	B3: 460-462.5nm	P1: 375-380nm
R2: 625-630nm	K2: 570-573nm	C2: 497.5-500nm	B4: 462.5-465nm	P2: 390-395nm
R3: 630-635nm	G1: 515-517.5nm	C3: 500-502.5nm	B5: 465-467.5nm	P3: 395-400nm
R4: 635-640nm	G2: 517.5-520nm	C4: 502.5-505nm	B6: 467.5-470nm	P4: 400-405nm
R5: 640-645nm	G3: 520-522.5nm	C5: 505-507.5nm	B7: 470-472.5nm	P5: 405-410nm
A1: 600-605nm	G4: 522.5-525nm	C6: 507.5-510nm	B8: 472.5-475nm	W1: 9000-11000
A2: 605-610nm	G5: 525-527.5nm	C7: 510-512.5nm		W2: 6000-8000K
Y1: 584-587nm	G6: 527.5-530nm	C8: 512.5-515nm		W3: 2700-4000K
Y2: 587-590nm	G7: 530-532.5nm	B1: 455-457.5nm		
Y3: 590-593nm	G8: 532.5-535nm	B2: 457.5-460nm		

Warrantee:

- 3 years warrantee for our red, yellow, amber and kelly items based on no more than 8 hours continuously lighting per day.
- 2 years warrantee for our Blue, Green, Cyan and Purple items based on no more than 8 hours continuously lighting per day.
- 1 years warrantee for our Cool White, Pure White and Warm White items based on no more than 8 hours continuously lighting per day.
- Electrical & Optical Characteristics consistency of same items all shipments.

Notes:

- Please use Digital Display based on our datasheet.
- Digital Display is sensitive to statics, be sure your equipments are anti-static when you use our Dot Matrixs.
- Pay more attention to your heat dissipation system when you use it, the better heat dissipation, the longer Digital Display lifespan.