



Chipsmall Limited consists of a professional team with an average of over 10 year of expertise in the distribution of electronic components. Based in Hongkong, we have already established firm and mutual-benefit business relationships with customers from,Europe,America and south Asia,supplying obsolete and hard-to-find components to meet their specific needs.

With the principle of “Quality Parts,Customers Priority,Honest Operation,and Considerate Service”,our business mainly focus on the distribution of electronic components. Line cards we deal with include Microchip,ALPS,ROHM,Xilinx,Pulse,ON,Everlight and Freescale. Main products comprise IC,Modules,Potentiometer,IC Socket,Relay,Connector.Our parts cover such applications as commercial,industrial, and automotives areas.

We are looking forward to setting up business relationship with you and hope to provide you with the best service and solution. Let us make a better world for our industry!



## Contact us

Tel: +86-755-8981 8866 Fax: +86-755-8427 6832

Email & Skype: info@chipsmall.com Web: www.chipsmall.com

Address: A1208, Overseas Decoration Building, #122 Zhenhua RD., Futian, Shenzhen, China



Description	Material	Finish
Body	Brass	Nickel
Pin	BE CU	Gold
Insulation	PTFE	N/A
Washer	Brass	Nickel
Nut	Brass	Nickel

REVISIONS			
REV	DESCRIPTION	DATE	APPV
B	Added new title block; updated footprint dimensions	13-MAR-12	BPM
C	Updated materials	10-JUL-12	SAH

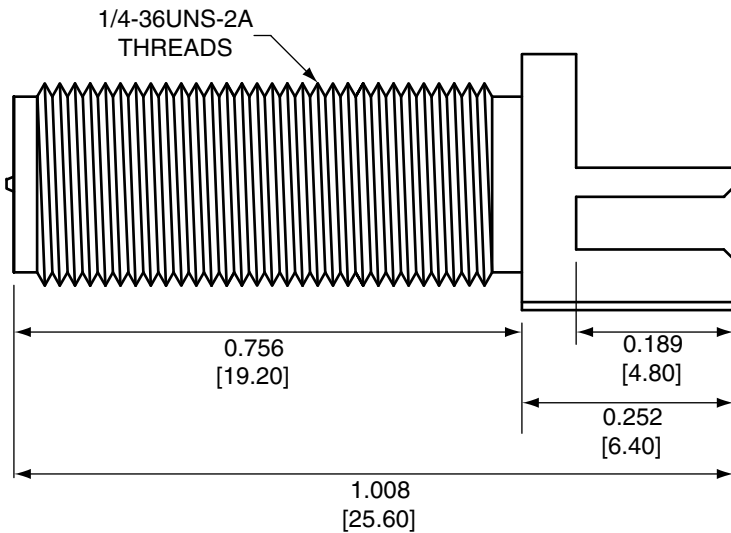

SIDE VIEW

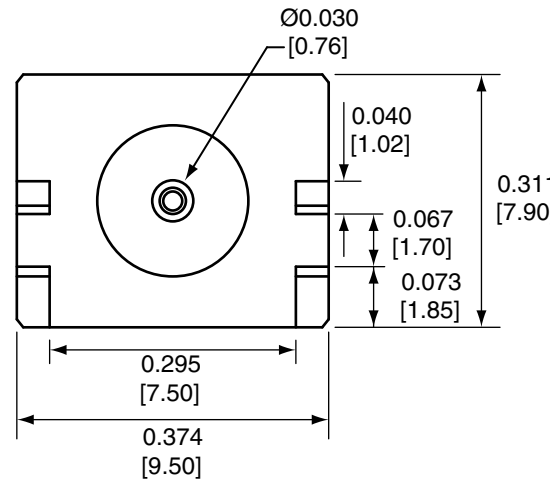

BACK VIEW

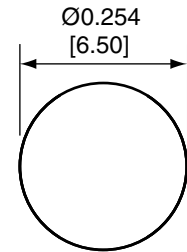

RECOMMENDED MOUNTING HOLE

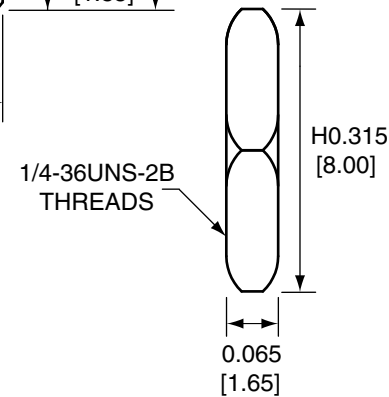

NUT

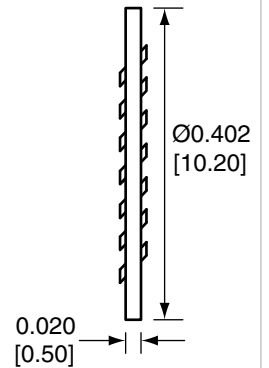

WASHER

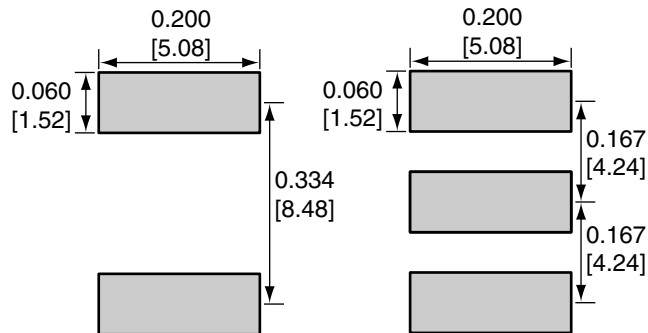

BOTTOM

TOP

RECOMMENDED FOOTPRINT

NOTES: (UNLESS OTHERWISE SPECIFIED)

1. ALL DIMENSIONS ARE IN INCHES [mm].
2. DIMENSIONS APPLY AFTER FINISHING.
3. MANUFACTURE TO BE COMPLIANT WITH EU RoHS DIRECTIVE.
4. SAFETY BREAK ALL SHARP CORNERS AND EDGES .02 MAXIMUM.

WARNING: THIS DRAWING CONTAINS PROPRIETARY INFORMATION THAT IS THE SOLE PROPERTY OF LINX TECHNOLOGIES, AND SHALL BE TREATED AS SUCH. NO DISCLOSURE OR REPRODUCTION OF THIS DOCUMENT IS PERMITTED, IN WHOLE OR IN PART, WITHOUT THE EXPRESS WRITTEN PERMISSION OF LINX TECHNOLOGIES OR ITS DESIGNATED AGENTS.

MATERIAL:	TOLERANCES: .020 [0.50]-.200 [5.00]= ±.008 [0.20] .200 [5.00]-1.200 [30.00]= ±.016 [0.40] 1.20 [30.0]-4.75 [120.0]= ±.024 [0.60] 4.75 [120.0]-12.40 [315.0]= ±.040 [1.0]	PROJECTION: 
FINISH:	DRAWN: B.MURPHY	DT: 13-MAR-12
	ENGR: S.HOGAN	DT: 13-MAR-12

<b>Linx</b>		159 ORT LANE MERLIN, OR 97532	
TITLE: RP-SMA FEMALE EDGE MOUNT FOR 0.062" THICK BOARD, EXTENDED			
SIZE	DWG. NO.	REV	
<b>A</b>	CONREV SMA003.062-L	<b>C</b>	
SCALE: 2:1	DO NOT SCALE DRAWING	SHEET 1 OF 1	