



Chipsmall Limited consists of a professional team with an average of over 10 year of expertise in the distribution of electronic components. Based in Hongkong, we have already established firm and mutual-benefit business relationships with customers from,Europe,America and south Asia,supplying obsolete and hard-to-find components to meet their specific needs.

With the principle of “Quality Parts,Customers Priority,Honest Operation,and Considerate Service”,our business mainly focus on the distribution of electronic components. Line cards we deal with include Microchip,ALPS,ROHM,Xilinx,Pulse,ON,Everlight and Freescale. Main products comprise IC,Modules,Potentiometer,IC Socket,Relay,Connector.Our parts cover such applications as commercial,industrial, and automotives areas.

We are looking forward to setting up business relationship with you and hope to provide you with the best service and solution. Let us make a better world for our industry!



Contact us

Tel: +86-755-8981 8866 Fax: +86-755-8427 6832

Email & Skype: info@chipsmall.com Web: www.chipsmall.com

Address: A1208, Overseas Decoration Building, #122 Zhenhua RD., Futian, Shenzhen, China



Description	Material	Finish
Body	Brass	Nickel
Pin	Brass	Gold
Pin Insulator	PTFE	N/A
Washer	Brass	Nickel
Nut	Brass	Nickel
Spacer	PTFE	N/A
Shield Sleeve	Brass	Nickel
Retaining Nut	Brass	Nickel
Crimp Ring	Brass	Nickel
Heat Shrink	Polyolefin	Black

REVISIONS			
REV	DESCRIPTION	DATE	APPV
B	Updated footprint and dimensions; Added new title block	29-JUN-12	SAH
C	Updated side view and retaining nut; Updated notes	6-AUG-18	CLL

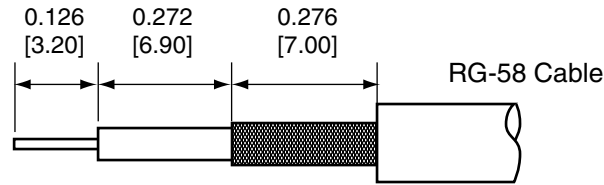

RECOMMENDED CABLE STRIPPING DIMENSIONS

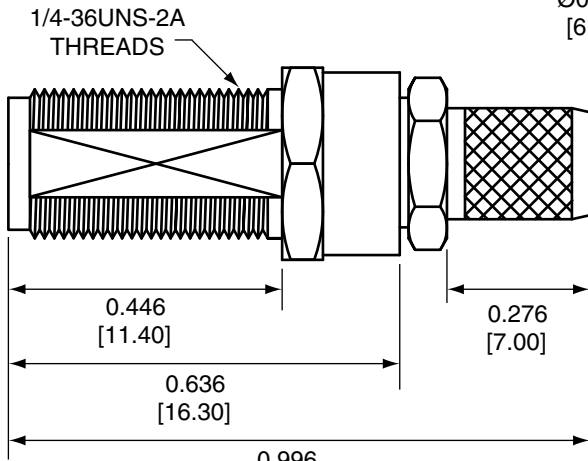

SIDE VIEW

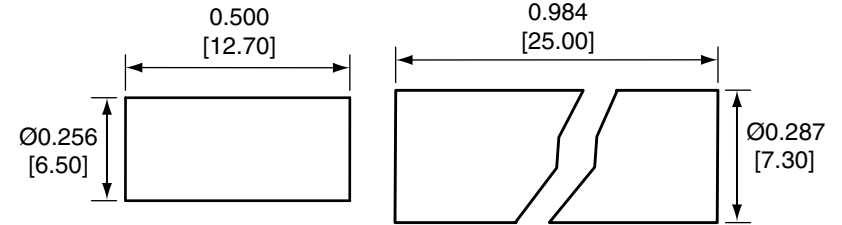

CRIMP RING

HEAT SHRINK

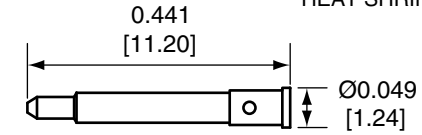

PIN

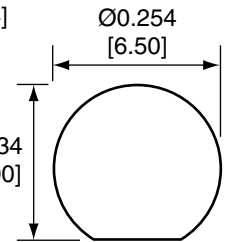

RECOMMENDED MOUNTING HOLE

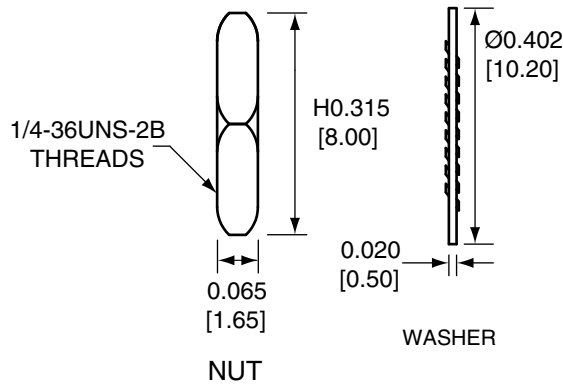

NUT

WASHER

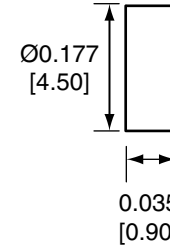

SPACER

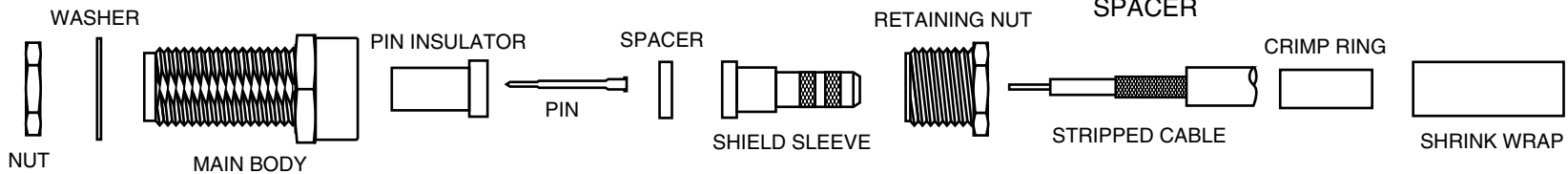

NOTES: (UNLESS OTHERWISE SPECIFIED)

- ALL DIMENSIONS ARE IN INCHES [mm].
- DIMENSIONS APPLY AFTER FINISHING.
- SAFETY BREAK ALL SHARP CORNERS AND EDGES .02 MAXIMUM.
- MANUFACTURE TO BE COMPLIANT WITH EU RoHS DIRECTIVE, USE MATERIALS THAT DO NOT CONTAIN REACH SUBSTANCES OF VERY HIGH CONCERN >1000ppm, AND USE DRC CONFLICT-FREE SOURCED MATERIALS.

CONREVSMA005-R58 ASSEMBLY INSTRUCTIONS

- Strip cable to recommended dimensions.
- Slip heat shrink and crimp ring onto stripped cable.
- Insert the stripped cable through the retaining nut, shield sleeve, and spacer.
- Solder the pin to the center conductor.
- Insert the pin into the pin insulator, then screw the main body onto the retaining nut.
- Wrap the braid around the tail of the body and crimp the ring with a 0.213" hex crimp tool (or one labeled for use with RG-58 cable).
- Use heat shrink to cover crimp.
- Use the nut and washer to secure the connector to a case.

WARNING: THIS DRAWING CONTAINS PROPRIETARY INFORMATION THAT IS THE SOLE PROPERTY OF LINX TECHNOLOGIES, AND SHALL BE TREATED AS SUCH. NO DISCLOSURE OR REPRODUCTION OF THIS DOCUMENT IS PERMITTED, IN WHOLE OR IN PART, WITHOUT THE EXPRESS WRITTEN PERMISSION OF LINX TECHNOLOGIES OR ITS DESIGNATED AGENTS.

MATERIAL:	TOLERANCES: .020 [0.50]-.200 [5.00]= ±.008 [0.20] .200 [5.00]-1.200 [30.00]= ±.016 [0.40] 1.20 [30.0]-4.75 [120.0]= ±.024 [0.60] 4.75 [120.0]-12.40 [315.0]= ±.040 [1.0]	PROJECTION:
FINISH:	DRAWN: B.MURPHY DT: 29-JUN-12	ANGLES: ±1°
	ENGR: S.HOGAN DT: 29-JUN-12	

		159 ORT LANE MERLIN, OR 97532	
		TITLE: RP-SMA FEMALE BULKHEAD MOUNT CABLE END CRIMP FOR RG58 CABLE	
SIZE A	DWG. NO. CONREVSMA005-R58	REV C	
SCALE: 2:1	DO NOT SCALE DRAWING	SHEET 1 OF 1	