



Chipsmall Limited consists of a professional team with an average of over 10 year of expertise in the distribution of electronic components. Based in Hongkong, we have already established firm and mutual-benefit business relationships with customers from,Europe,America and south Asia,supplying obsolete and hard-to-find components to meet their specific needs.

With the principle of “Quality Parts,Customers Priority,Honest Operation,and Considerate Service”,our business mainly focus on the distribution of electronic components. Line cards we deal with include Microchip,ALPS,ROHM,Xilinx,Pulse,ON,Everlight and Freescale. Main products comprise IC,Modules,Potentiometer,IC Socket,Relay,Connector.Our parts cover such applications as commercial,industrial, and automotives areas.

We are looking forward to setting up business relationship with you and hope to provide you with the best service and solution. Let us make a better world for our industry!



Contact us

Tel: +86-755-8981 8866 Fax: +86-755-8427 6832

Email & Skype: info@chipsmall.com Web: www.chipsmall.com

Address: A1208, Overseas Decoration Building, #122 Zhenhua RD., Futian, Shenzhen, China



Cree® P4 LED CP41B-BFS/GFS Data Sheet

This revolutionary package design allows the lighting designer to reduce the number of LEDs required and provide a more uniform and unique illuminated appearance than with other LED solutions.

This is possible through the efficient optical package design and high current capabilities. The low profile package can be easily coupled with reflectors or lenses to efficiently distribute light and provide the desired lit appearance. This product family employs green and blue LED materials, which allow designers to match the color of many lighting applications like vehicle signal lamps and amusement lighting.



FEATURES

- Size (mm): 7.6 x 7.6
- Color and Typical Dominant Wavelength (nm):
Green (527)
Blue (470)
- Luminous Flux (lm)
Green (4400 - 8730)
Blue (1650 - 3300)
- Lead-Free
- RoHS Compliant

APPLICATIONS

- Channel Letter
- Amusement



Absolute Maximum Ratings ($T_A = 25^\circ\text{C}$)

Items	Symbol	Absolute Maximum Rating	Unit
		Blue/Green	
Forward Current	I_F	35	mA
Peak Forward Current ^{Note}	I_{FP}	100	mA
Reverse Voltage	V_R	5	V
Power Dissipation	P_D	154	mW
Operation Temperature	T_{opr}	-40 ~ +100	$^\circ\text{C}$
Storage Temperature	T_{stg}	-40 ~ +100	$^\circ\text{C}$
Lead Soldering Temperature	T_{sol}	Max. 260 $^\circ\text{C}$ for 5 sec. max. (3 mm from the base of the epoxy bulb)	

Note: Pulse width ≤ 0.1 msec, duty $\leq 1/10$.

Typical Electrical & Optical Characteristics ($T_A = 25^\circ\text{C}$)

Characteristics	Color	Symbol	Condition	Unit	Minimum	Typical	Maximum
Forward Voltage	Blue/Green	V_F	$I_F = 30$ mA	V		3.6	4.4
Reverse Current	Blue/Green	I_R	$V_R = 5$ V	μA			100
Dominant Wavelength	Blue	λ_D	$I_F = 30$ mA	nm	460	470	475
	Green	λ_D	$I_F = 30$ mA	nm	515	527	535
Luminous Flux	Blue	Φ_v	$I_F = 30$ mA	mlm	1650	2500	
	Green	Φ_v	$I_F = 30$ mA	mlm	4400	6500	
50% Power Angle	Blue/Green	$2\theta_{1/2}$	$I_F = 30$ mA	deg		70	



Flux Bin Limit ($I_F = 30 \text{ mA}$)

Blue

Bin Code	Min.(mlm)	Max.(mlm)
F0	1650	2200
G0	2200	2750
H0	2750	3300

Green

Bin Code	Min.(mlm)	Max.(mlm)
L0	4400	5500
M0	5500	6600
N0	6600	8730

- Tolerance of measurement of luminous Flux is $\pm 15\%$

Color Bin Limit ($I_F = 30 \text{ mA}$)

Blue

Bin Code	Min.(nm)	Max.(nm)
B3	460	465
B4	465	470
B5	470	475

Green

Bin Code	Min.(nm)	Max.(nm)
G6	515	520
G7	520	525
G8	525	530
G9	530	535

- Tolerance of measurement of dominant wavelength is $\pm 1 \text{ nm}$

VF Bin Limit ($I_F = 30 \text{ mA}$)

Blue

Bin Code	Min.(V)	Max.(V)
27	2.8	3.0
28	3.0	3.2
29	3.2	3.4
2a	3.4	3.6
2b	3.6	3.8
2c	3.8	4.0
2d	4.0	4.2
2e	4.2	4.4

Green

Bin Code	Min.(V)	Max.(V)
27	2.8	3.0
28	3.0	3.2
29	3.2	3.4
2a	3.4	3.6
2b	3.6	3.8
2c	3.8	4.0
2d	4.0	4.2
2e	4.2	4.4

- Tolerance of measurement of VF is $\pm 0.05\text{V}$



Order Code Table*

Color	Kit Number	Viewing Angle	Luminous Flux (mlm)		Dominant Wavelength			
			Min.	Max.	Color Bin	Min. (nm)	Color Bin	Max. (nm)
Blue	CP41B-BFS-CF0H0354	70	1650	3300	B3	460	B5	475
Blue	CP41B-BFS-CF0H0454	70	1650	3300	B4	465	B5	475
Blue	CP41B-BFS-CG0H0454	70	2200	3300	B4	465	B5	475

Color	Kit Number	Viewing Angle	Luminous Flux (mlm)		Dominant Wavelength			
			Min.	Max.	Color Bin	Min. (nm)	Color Bin	Max. (nm)
Green	CP41B-GFS-CL0N0694	70	4400	8730	G6	515	G9	535
Green	CP41B-GFS-CL0N0674	70	4400	8730	G6	515	G7	525
Green	CP41B-GFS-CL0N0784	70	4400	8730	G7	520	G8	530
Green	CP41B-GFS-CM0N0674	70	5500	8730	G6	515	G7	525
Green	CP41B-GFS-CM0N0784	70	5500	8730	G7	520	G8	530

Notes:

1. The above kit numbers represent order codes which include multiple flux-bin and color-bin codes.
Only one flux-bin code and one color-bin code will be shipped on each reel.
And single flux-bin code, single color bin-codes will not be orderable.
2. Please refer to the "Cree LED Lamp Reliability Test Standards" document for reliability test conditions.
3. Please refer to the "Cree LED Lamp Soldering & Handling" document for information about how to use this LED product safely.

Graphs



FIG.1 FORWARD CURRENT VS. FORWARD VOLTAGE.

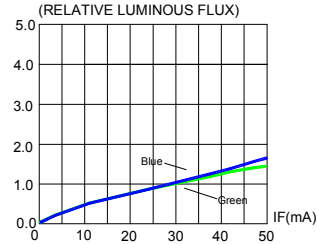

FIG.2 RELATIVE LUMINOUS FLUX VS. FORWARD CURRENT

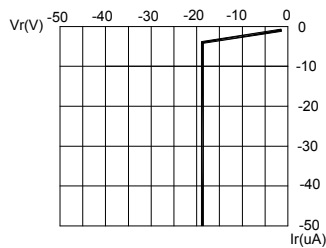

FIG.3 BLUE & GREEN REVERSE CURRENT VS. REVERSE VOLTAGE.

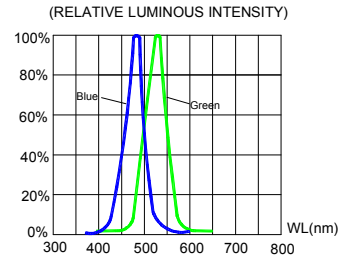

FIG.4 RELATIVE LUMINOUS INTENSITY VS. WAVELENGTH.

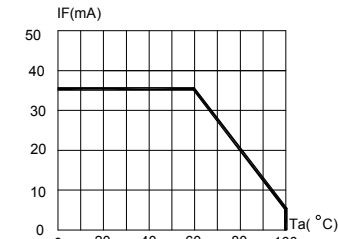

FIG.5 BLUE & GREEN MAXIMUM FORWARD DC CURRENT VS AMBIENT TEMPERATURE (Tjmax=105°C)

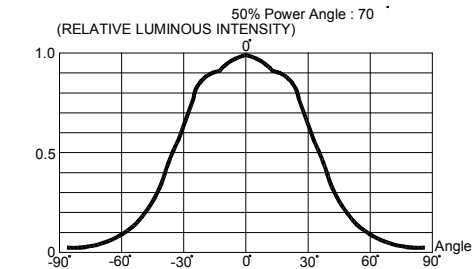

FIG.6 FAR FIELD PATTERN

The above data are collected from statistical figures that do not necessarily correspond to the actual parameters of each single LED. Hence, these data will be changed without further notice.

Mechanical Dimensions

All dimensions are in mm. Tolerance is ± 0.25 mm unless otherwise noted.

An epoxy meniscus may extend about 1.5 mm down the leads.

Burr around bottom of epoxy may be 0.5 mm max.

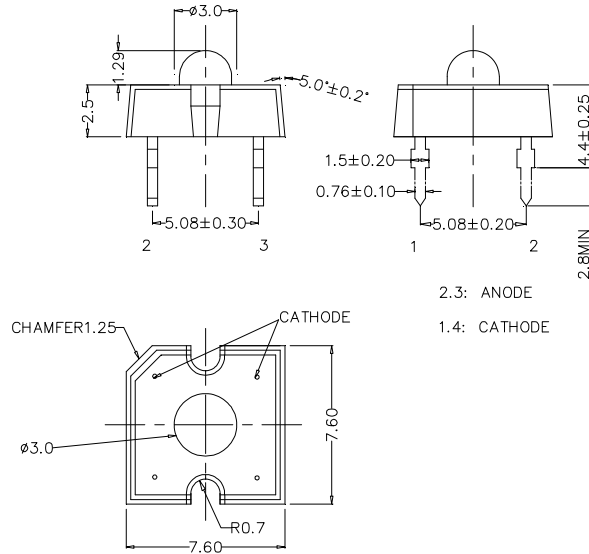

Notes

RoHS Compliance

The levels of environmentally sensitive, persistent biologically toxic (PBT), persistent organic pollutants (POP), or otherwise restricted materials in this product are below the maximum concentration values (also referred to as the threshold limits) permitted for such substances, or are used in an exempted application, in accordance with EU Directive 2002/95/EC on the restriction of the use of certain hazardous substances in electrical and electronic equipment (RoHS), as amended through April 21, 2006.

Vision Advisory Claim

Users should be cautioned not to stare at the light of this LED product. The bright light can damage the eye.



Kit Number System

Cree LED lamps are tested and sorted into performance bins. A bin is specified by ranges of color, forward voltage, and brightness. Sorted LEDs are packaged for shipping in various convenient options. Please refer to the "Cree LED Lamp Packaging Standard" document for more information about shipping and packaging options.

Cree LEDs are sold by order codes in combinations of bins called kits. Order codes are configured in the following manner:

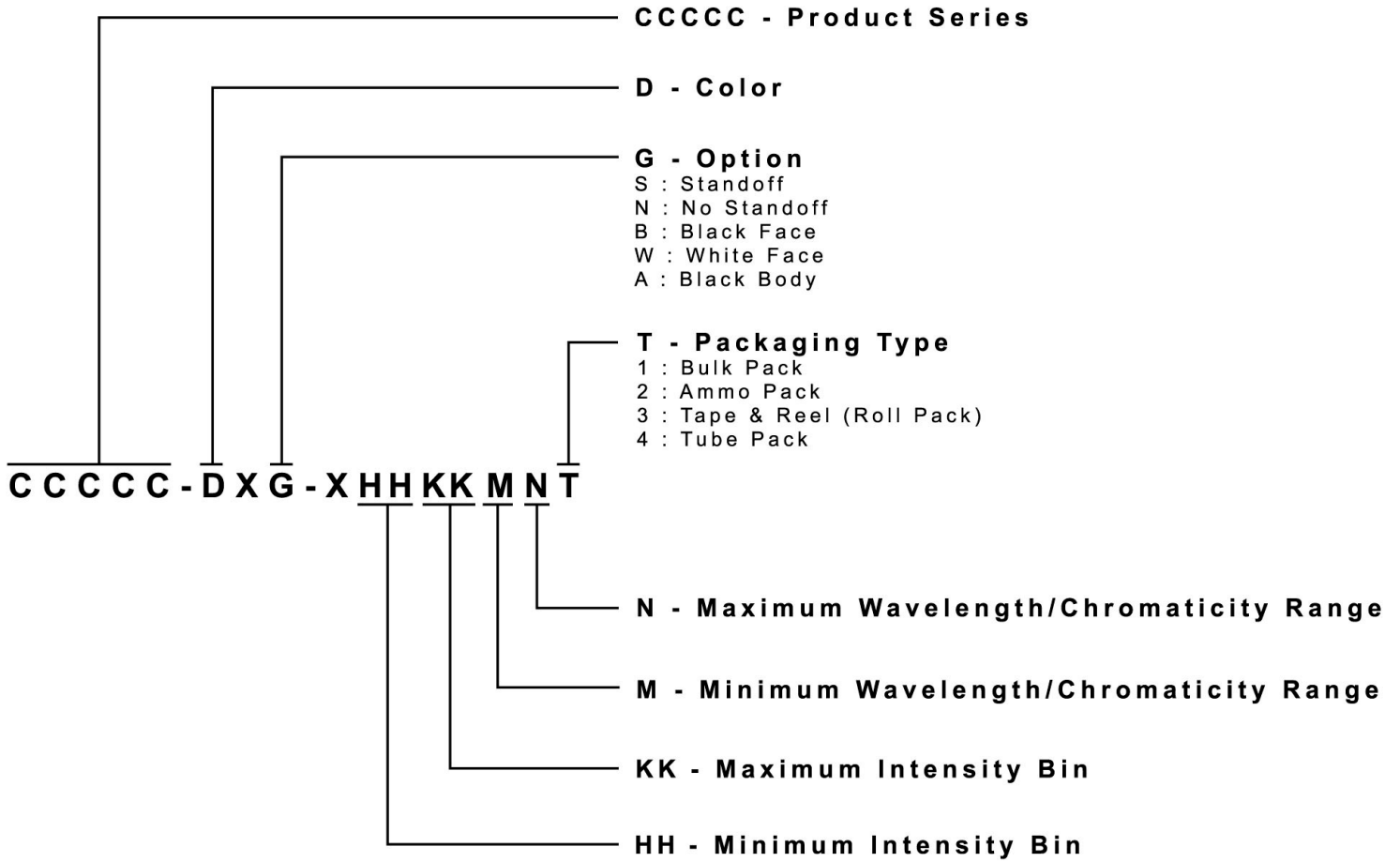

Package

Features:

- The LEDs are packed in cardboard boxes after packaging in normal or anti-electrostatic bags.
- Cardboard boxes will be used to protect the LEDs from mechanical shock during transportation.
- The boxes are not water resistant, and they must be kept away from water and moisture.
- The Tube Pack type of packaging.
- Max 60 pcs per tube.

