



Chipsmall Limited consists of a professional team with an average of over 10 year of expertise in the distribution of electronic components. Based in Hongkong, we have already established firm and mutual-benefit business relationships with customers from,Europe,America and south Asia,supplying obsolete and hard-to-find components to meet their specific needs.

With the principle of “Quality Parts,Customers Priority,Honest Operation,and Considerate Service”,our business mainly focus on the distribution of electronic components. Line cards we deal with include Microchip,ALPS,ROHM,Xilinx,Pulse,ON,Everlight and Freescale. Main products comprise IC,Modules,Potentiometer,IC Socket,Relay,Connector.Our parts cover such applications as commercial,industrial, and automotives areas.

We are looking forward to setting up business relationship with you and hope to provide you with the best service and solution. Let us make a better world for our industry!



Contact us

Tel: +86-755-8981 8866 Fax: +86-755-8427 6832

Email & Skype: info@chipsmall.com Web: www.chipsmall.com

Address: A1208, Overseas Decoration Building, #122 Zhenhua RD., Futian, Shenzhen, China



SERIES: CP60 | **DESCRIPTION:** PELTIER MODULE

FEATURES

- solid state device
- precise temperature control
- quiet operation

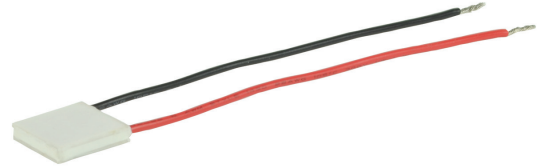

MODEL

MODEL	input voltage ¹ max (Vdc)	input current ² max (A)	output Qmax ³		output ΔTmax ⁴	
			T _h =27°C (W)	T _h =50°C (W)	T _h =27°C (°C)	T _h =50°C (°C)
CP60133	3.8	6.0	12.2	13.6	66	72
CP60233	8.6	6.0	27.9	31.2	66	72
CP60333	15.4	6.0	50.5	56.5	66	72
CP60140	2.1	6.0	7.1	7.9	68	75
CP60240	3.8	6.0	13.0	14.5	68	75
CP60301540	4.2	6.0	14.5	16.1	68	75
CP60340	8.6	6.0	29.0	32.4	68	75
CP60440	15.4	6.0	53.0	59.3	68	75

- Notes:
1. Maximum voltage at ΔT max and T_h=27°C
 2. Maximum current to achieve ΔT max
 3. Maximum heat absorbed at cold side occurs at I_{max}, V_{max}, and ΔT=0°C
 4. Maximum temperature difference occurs at I_{max}, V_{max}, and Q=0W (ΔT max measured in a vacuum at 1.3 Pa)

PART NUMBER KEY

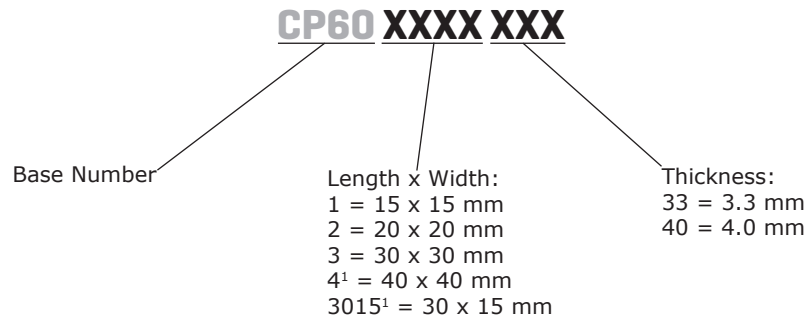

- Notes: 1. Only available in 4.0 mm thickness

SPECIFICATIONS

parameter	conditions/description	min	typ	max	units
internal resistance ¹	CP60133	0.45	0.50	0.55	Ω
	CP60233	1.08	1.20	1.32	Ω
	CP60333	1.98	2.20	2.42	Ω
	CP60140	0.261	0.29	0.319	Ω
	CP60240	0.477	0.53	0.583	Ω
	CP60301540	0.513	0.57	0.627	Ω
	CP60340	1.089	1.21	1.331	Ω
	CP60440	1.953	2.17	2.387	Ω
solder melting temperature	connection between thermoelectric pairs	138			°C
assembly compression	all other models			0.98	MPa
	CP60301540			1	MPa
hot side plate				80	°C
RoHS	2011/65/EU				

Note: 1. Measured by AC 4-terminal method at 25°C

MECHANICAL DRAWING

units: mm

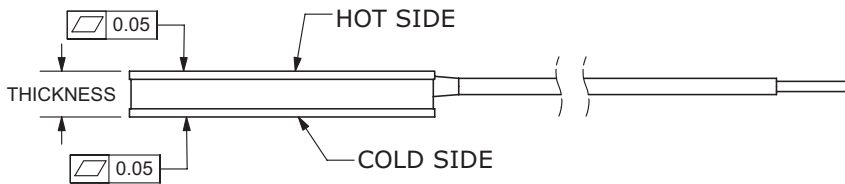

	MATERIAL	PLATING
ceramic plate	96% AL ₂ O ₃	
wire leads	20 AWG	tin
sealer	silicon rubber 703 RTV (between cold and hot side plates)	
joint cover	silicon rubber 703 RTV	
marking	P/N & S/N printed on cold side surface	

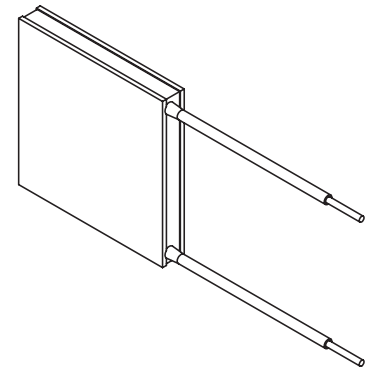
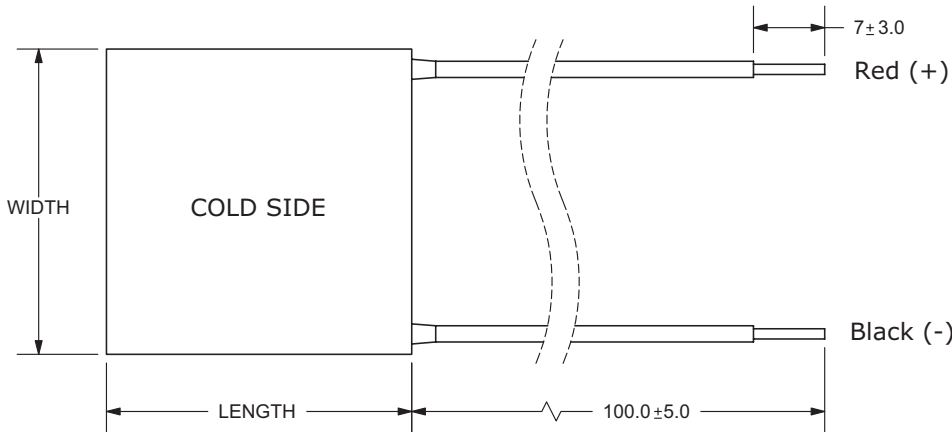

MODEL NO.	LENGTH (mm)	WIDTH (mm)	THICKNESS (mm)
CP60133	15 ±0.3	15 ±0.3	3.3 ±0.1
CP60233	20 ±0.3	20 ±0.3	3.3 ±0.1
CP60333	30 ±0.3	30 ±0.3	3.3 ±0.1
CP60140	15 ±0.3	15 ±0.3	4.0 ±0.1
CP60240	20 ±0.3	20 ±0.3	4.0 ±0.1
CP60301540	30 ±0.3	15 ±0.3	4.05 ±0.1
CP60340	30 ±0.3	30 ±0.3	4.0 ±0.1
CP60440	40 ±0.3	40 ±0.3	4.0 ±0.1

CP60133 PERFORMANCE (Th=27°C)

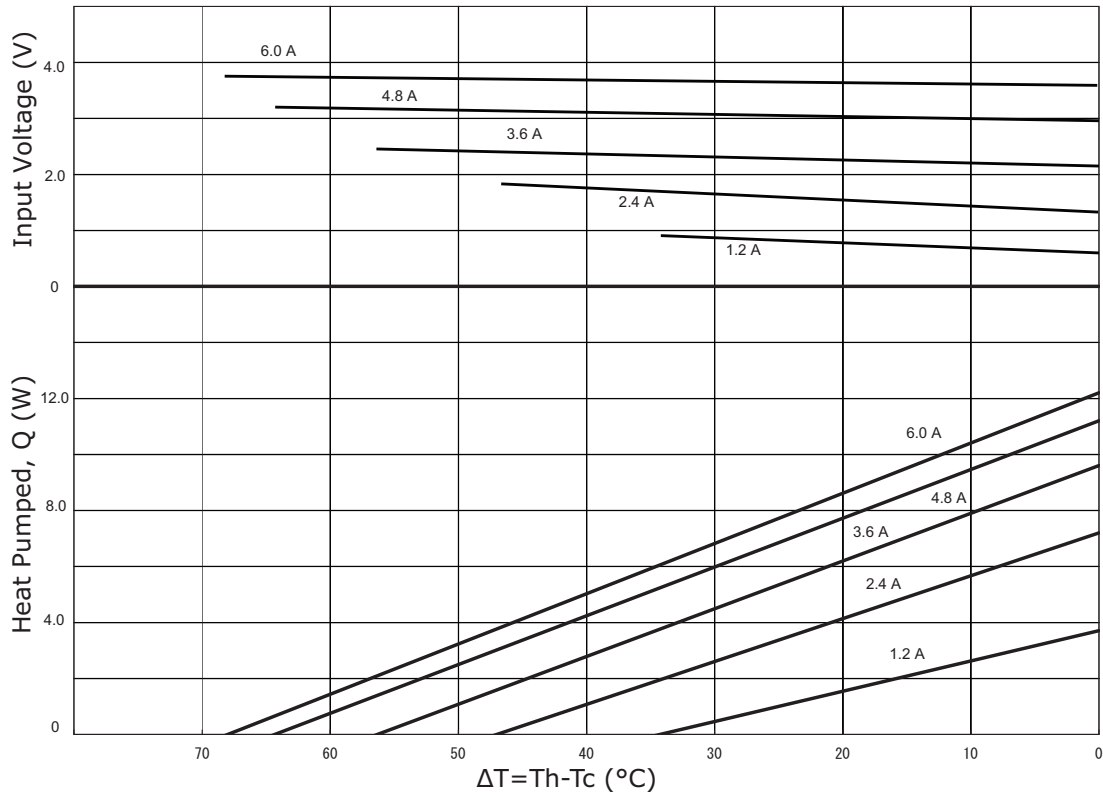

CP60133 PERFORMANCE (Th=50°C)

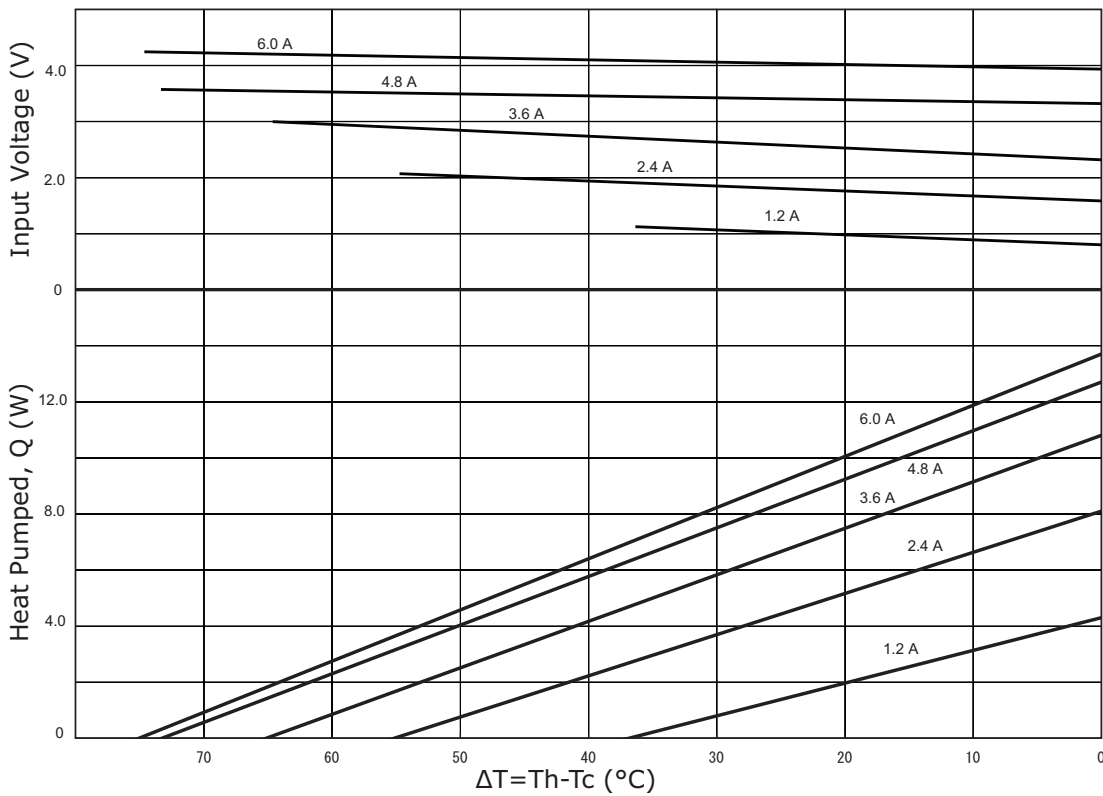

CP60233 PERFORMANCE (Th=27°C)

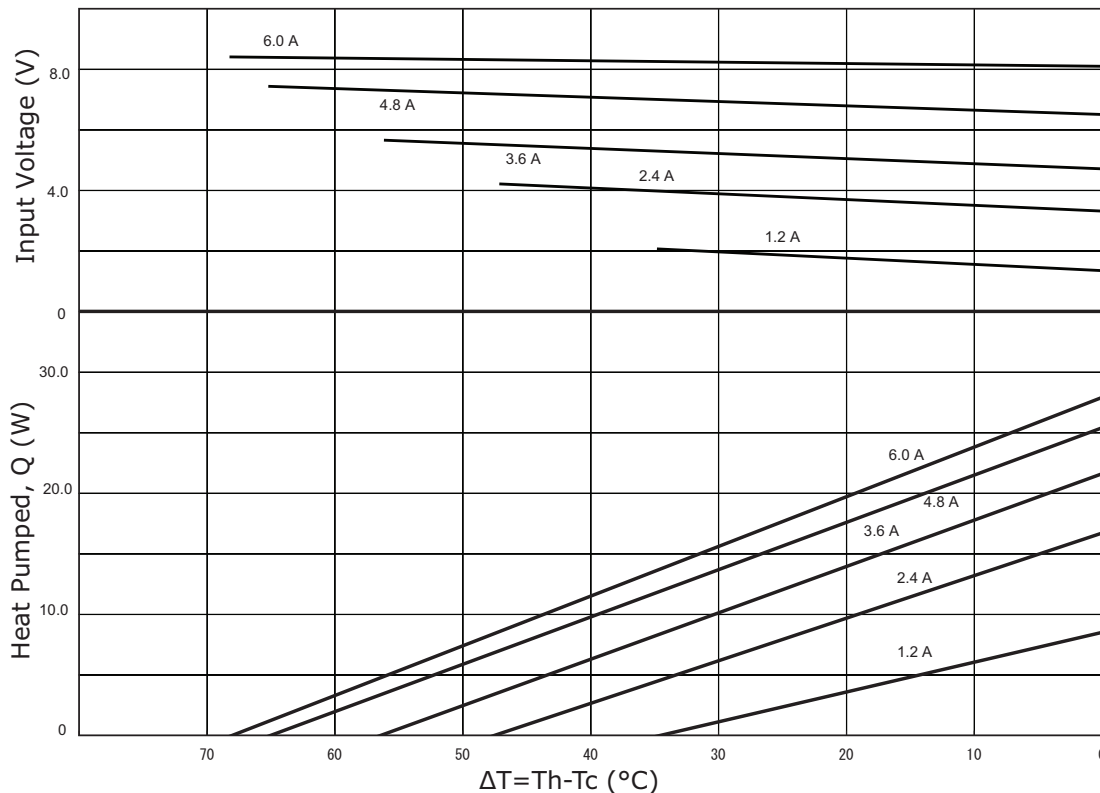

CP60233 PERFORMANCE (Th=50°C)

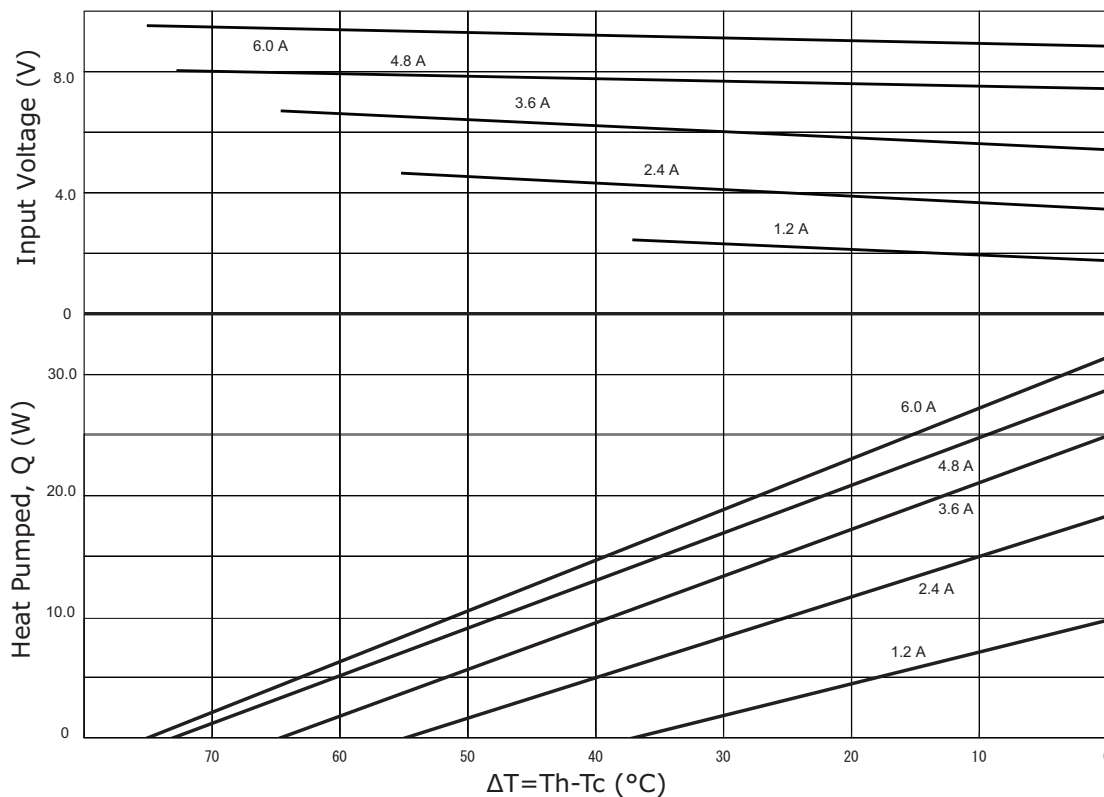

CP60333 PERFORMANCE (Th=27°C)

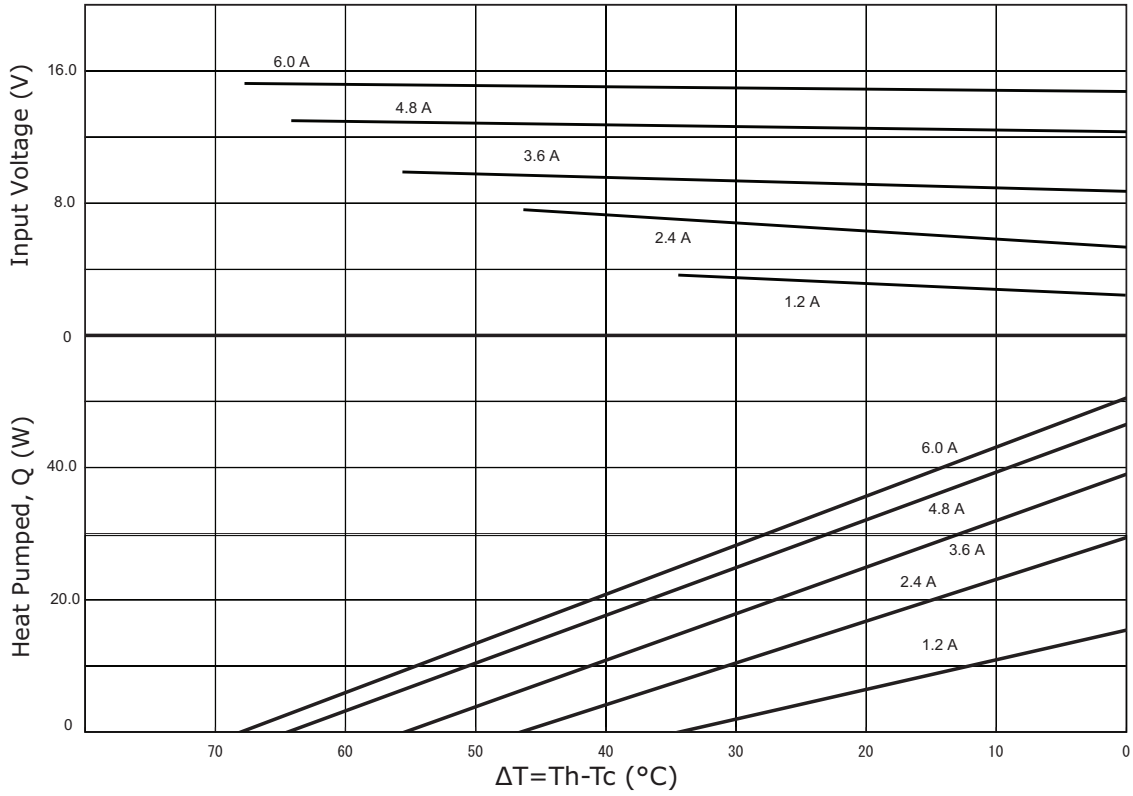

CP60333 PERFORMANCE (Th=50°C)

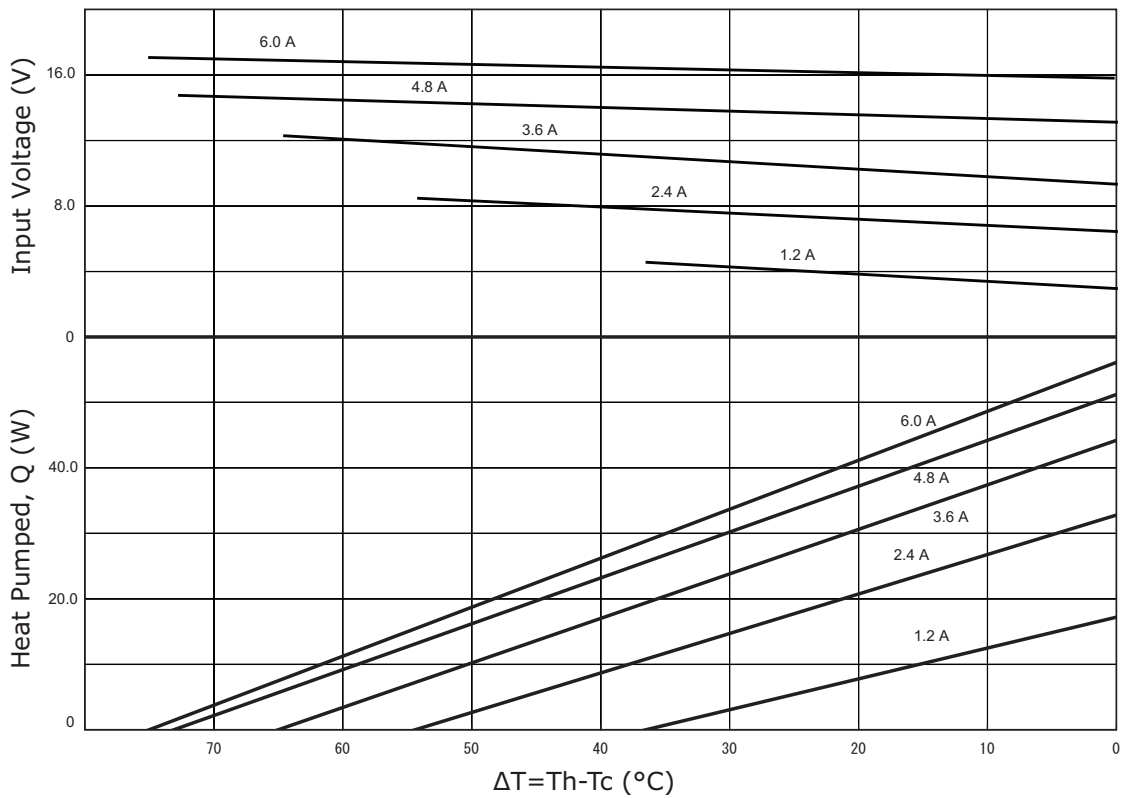

CP60140 PERFORMANCE (Th=27°C)

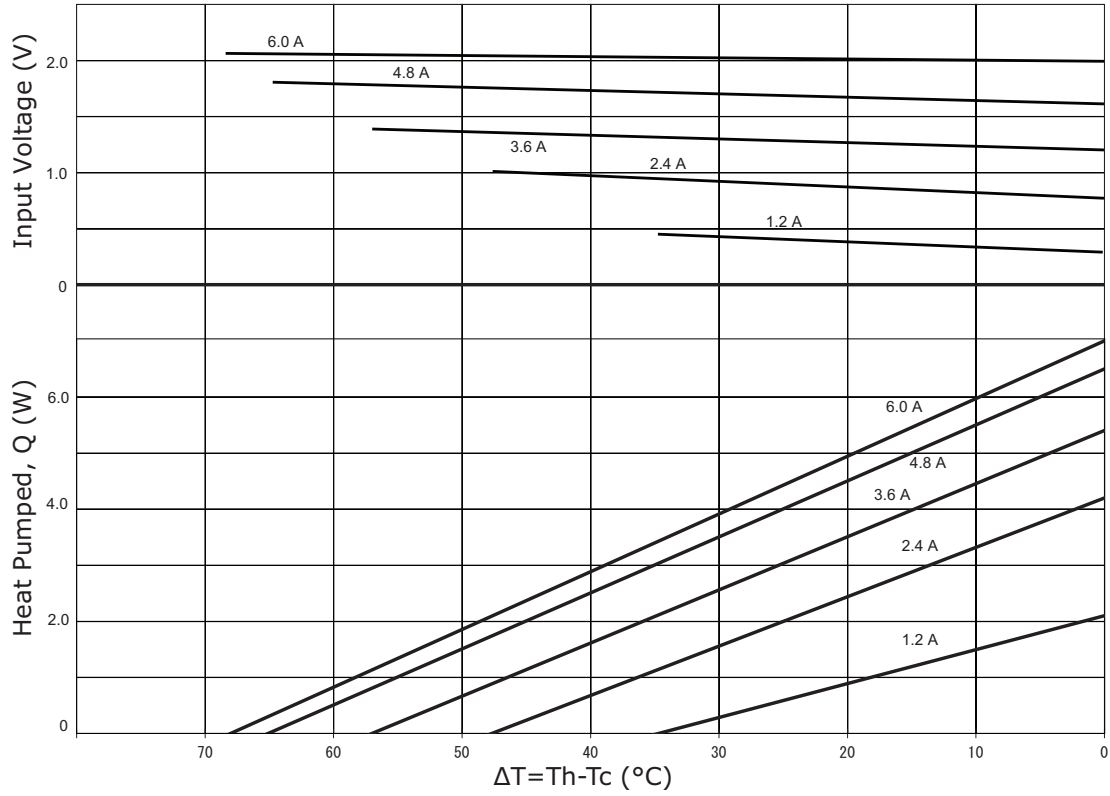

CP60140 PERFORMANCE (Th=50°C)

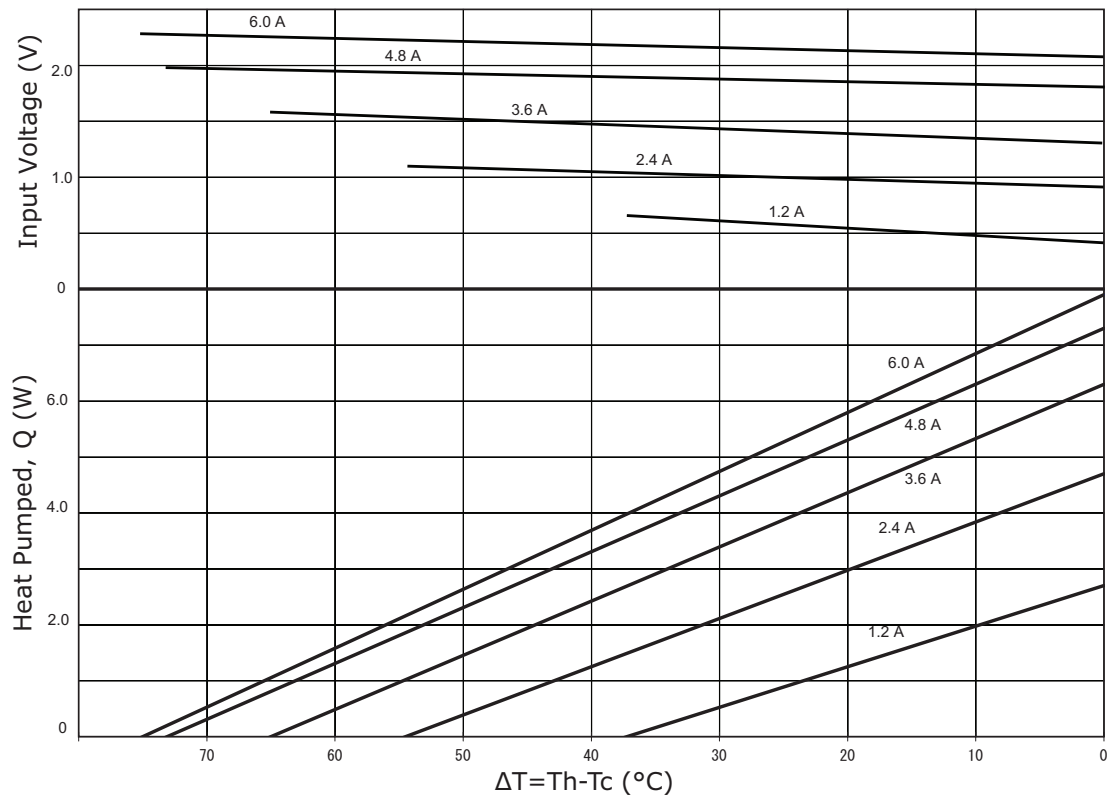

CP60240 PERFORMANCE (Th=27°C)

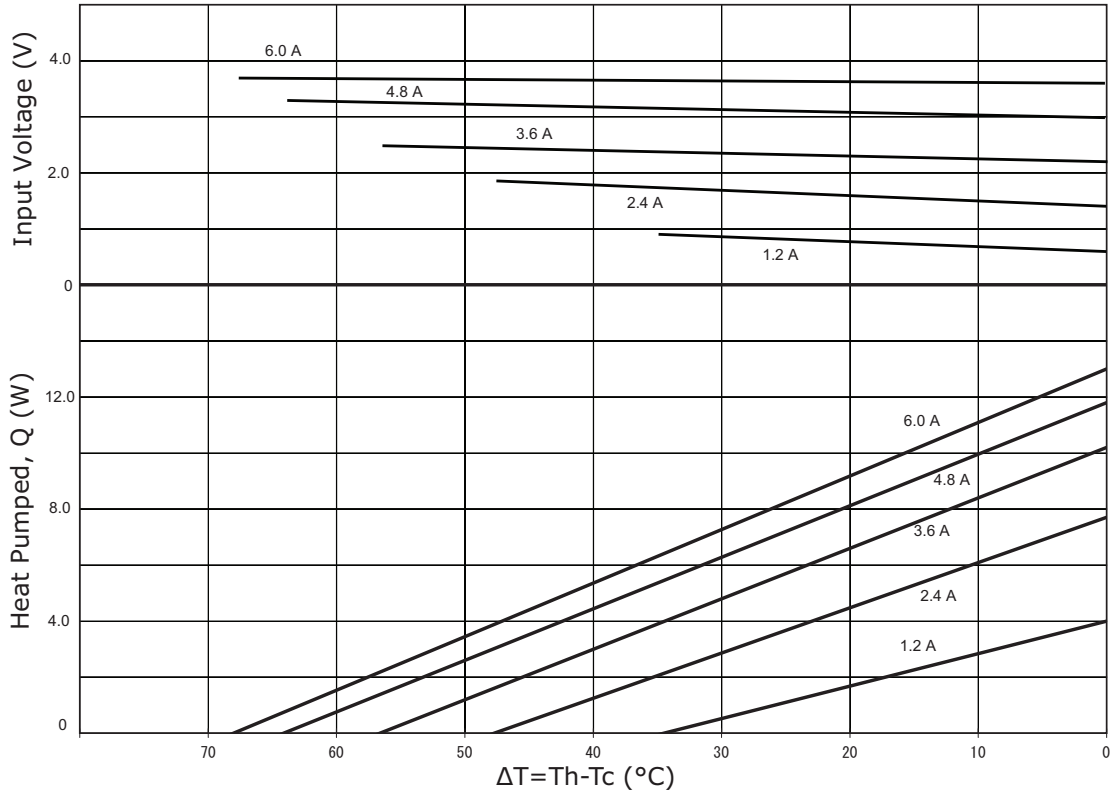

CP60240 PERFORMANCE (Th=50°C)

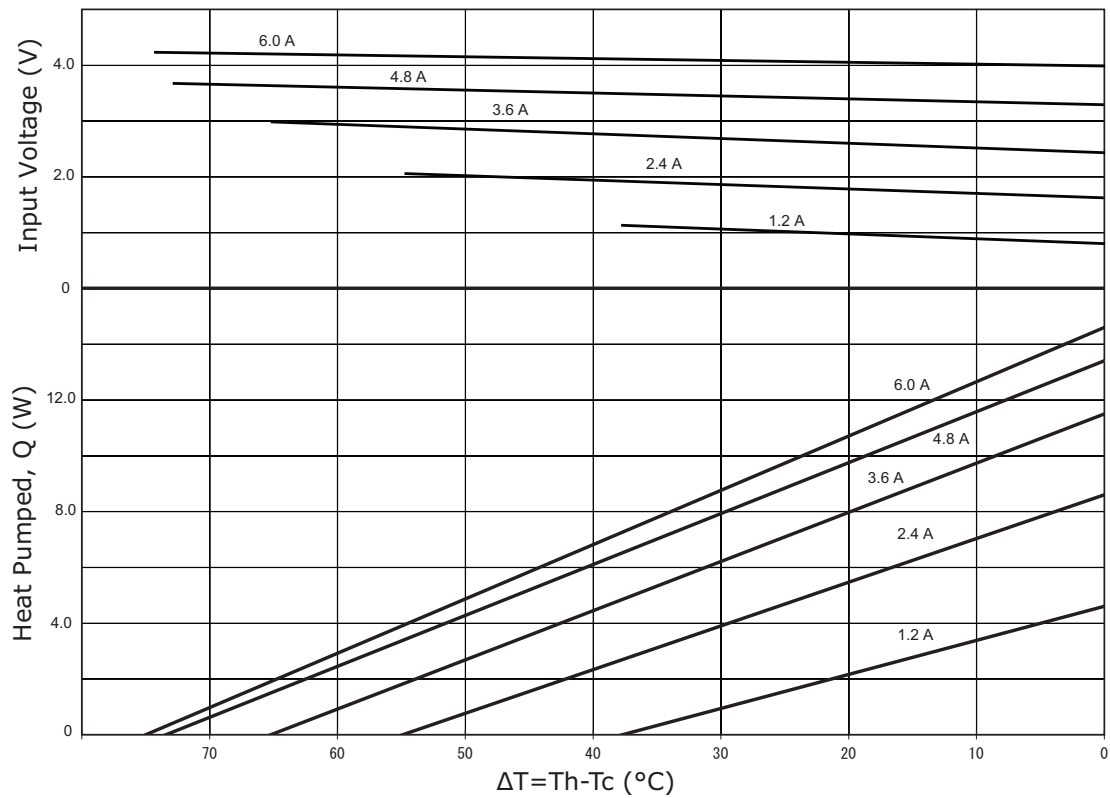

CP60301540 PERFORMANCE (Th=27°C)

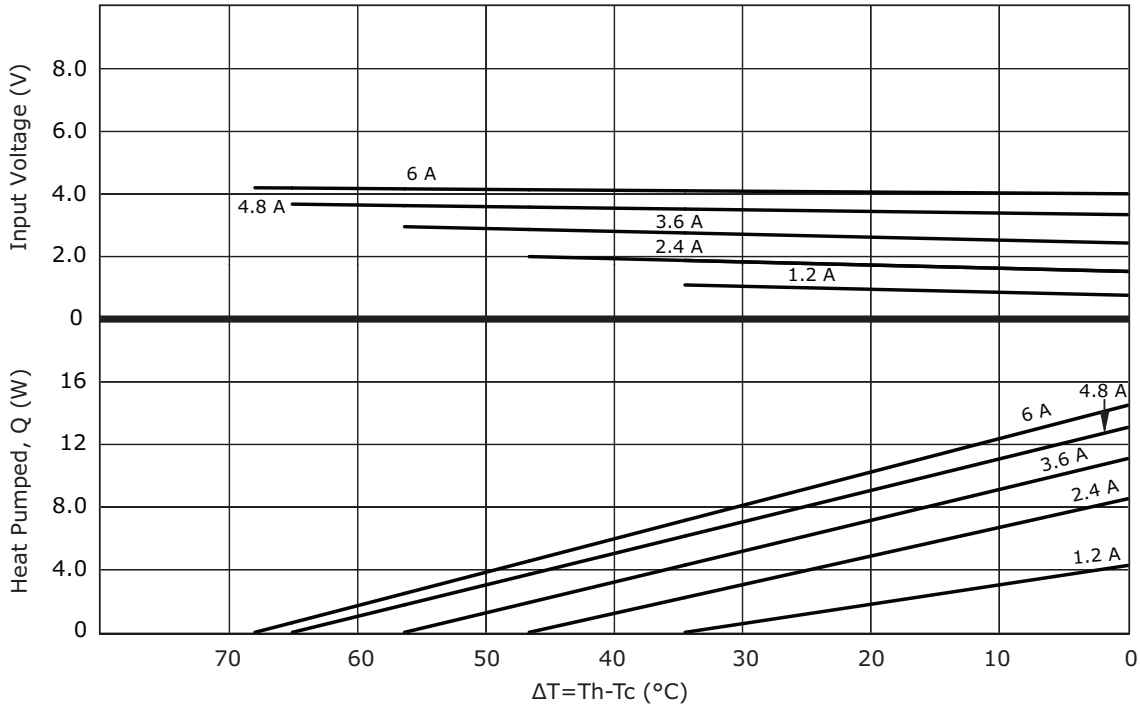

CP60301540 PERFORMANCE (Th=50°C)

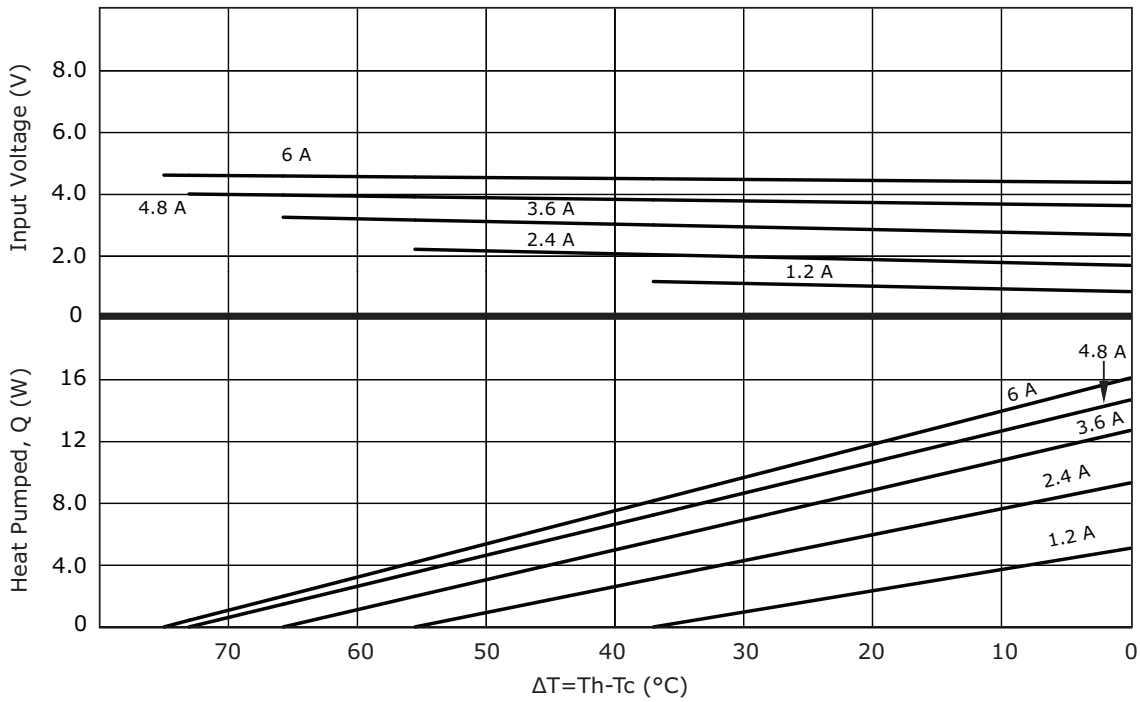

CP60340 PERFORMANCE (Th=27°C)

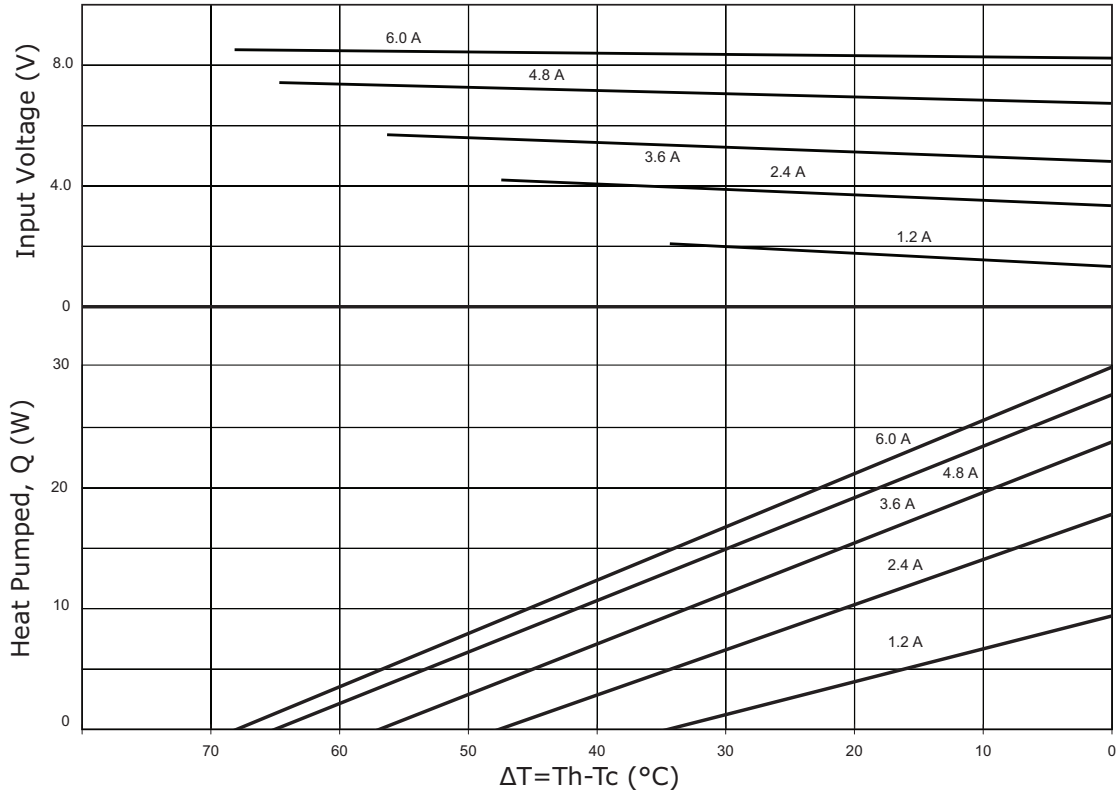

CP60340 PERFORMANCE (Th=50°C)

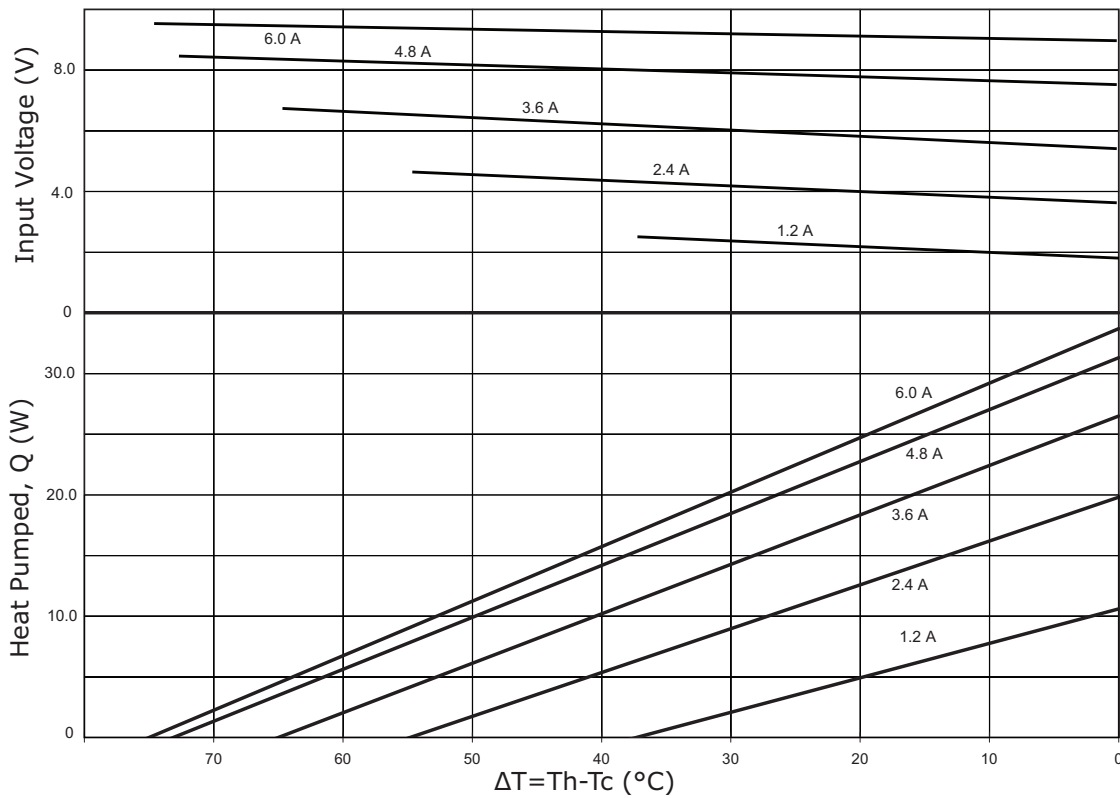

CP60440 PERFORMANCE (Th=27°C)

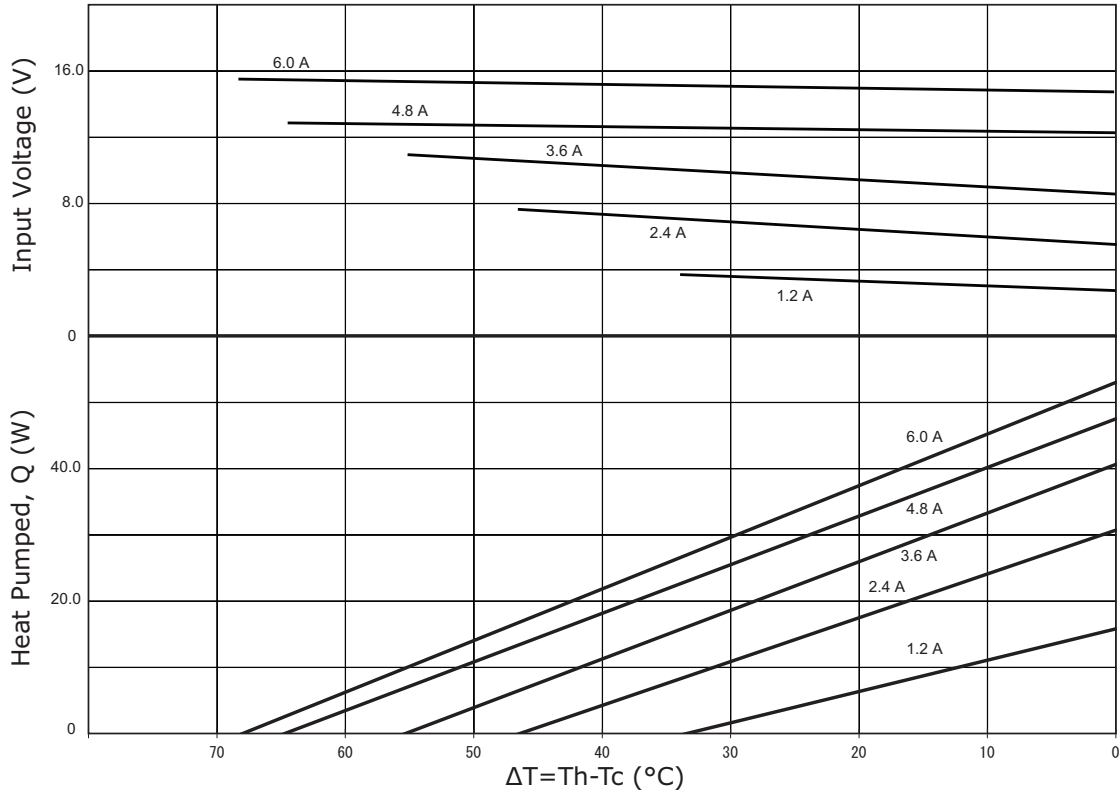

CP60440 PERFORMANCE (Th=50°C)

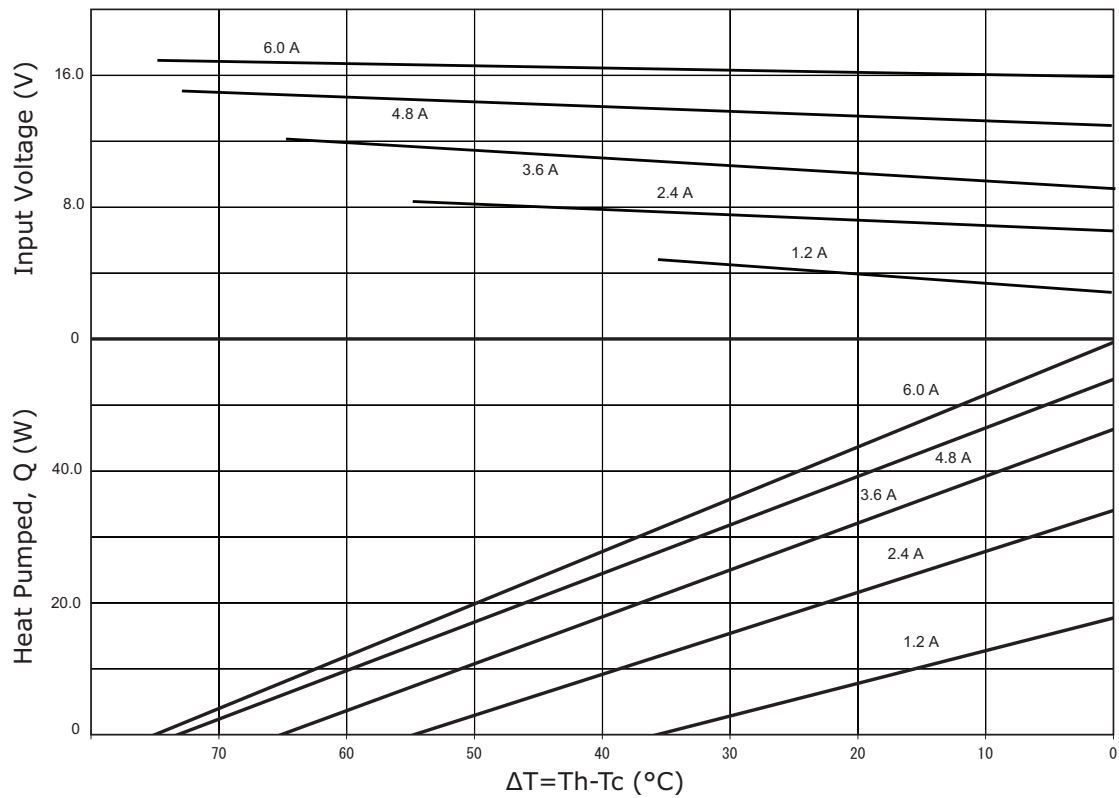

REVISION HISTORY

rev.	description	date
1.0	initial release	09/03/2009
1.01	applied new template	05/08/2012
1.02	added new models	09/09/2016

The revision history provided is for informational purposes only and is believed to be accurate.



CUI INC[®]

Headquarters
20050 SW 112th Ave.
Tualatin, OR 97062
800.275.4899

Fax 503.612.2383
cui.com
techsupport@cui.com

CUI offers a one (1) year limited warranty. Complete warranty information is listed on our website.

CUI reserves the right to make changes to the product at any time without notice. Information provided by CUI is believed to be accurate and reliable. However, no responsibility is assumed by CUI for its use, nor for any infringements of patents or other rights of third parties which may result from its use.

CUI products are not authorized or warranted for use as critical components in equipment that requires an extremely high level of reliability. A critical component is any component of a life support device or system whose failure to perform can be reasonably expected to cause the failure of the life support device or system, or to affect its safety or effectiveness.