



Chipsmall Limited consists of a professional team with an average of over 10 year of expertise in the distribution of electronic components. Based in Hongkong, we have already established firm and mutual-benefit business relationships with customers from,Europe,America and south Asia,supplying obsolete and hard-to-find components to meet their specific needs.

With the principle of “Quality Parts,Customers Priority,Honest Operation,and Considerate Service”,our business mainly focus on the distribution of electronic components. Line cards we deal with include Microchip,ALPS,ROHM,Xilinx,Pulse,ON,Everlight and Freescale. Main products comprise IC,Modules,Potentiometer,IC Socket,Relay,Connector.Our parts cover such applications as commercial,industrial, and automotives areas.

We are looking forward to setting up business relationship with you and hope to provide you with the best service and solution. Let us make a better world for our industry!



Contact us

Tel: +86-755-8981 8866 Fax: +86-755-8427 6832

Email & Skype: info@chipsmall.com Web: www.chipsmall.com

Address: A1208, Overseas Decoration Building, #122 Zhenhua RD., Futian, Shenzhen, China





Parameter	Rating	Units
Open Circuit Voltage	8	V
Short Circuit Current	50	μA

* Direct sunlight (Approximately 6000 lux)

Features

- 8V Output
- Triggers with Natural Sunlight
- Provides True Wireless Power
- No EMI/RFI Generation
- Wave Solderable
- Replacement of Discrete Components
- Solid State Reliability

Applications

- Portable Electronics
- Solar Battery Chargers
- Battery Operated Equipment
- Consumer Electronics
- Off-Grid Installation
- Wireless Sensors and Detection
- Flame Detection
- Self Powered Sunlight/ Light Detection
- Self Powered Products
- Remote Installation

Description

The CPC1832 is a monolithic photovoltaic string of solar cells on Silicon-On-Insulator (SOI). This patented design allows for higher voltage solar cells in a compact package. When operating in sunlight or a bright artificial light environment, the optical energy will activate the cell array, and generate a voltage at the output. The solar cells are capable of generating a floating source voltage and current sufficient to drive and power CMOS ICs, logic gates, and/or provide "trickle charge" for battery applications.

Ordering Information

Part #	Description
CPC1832N	16-Pin Clear Molded SOIC Package (50/Tube)
CPC1832NTR	16-Pin Clear Molded SOIC Package (1000/Reel)

Block Diagram

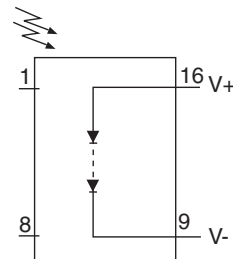

Absolute Maximum Ratings

Parameter	Ratings	Units
Reverse Voltage	10	V
Operational Temperature	-40 to +85	°C
Storage Temperature	-40 to +125	°C

Electrical absolute maximum ratings are at 25°C

Absolute Maximum Ratings are stress ratings. Stresses in excess of these ratings can cause permanent damage to the device. Functional operation of the device at conditions beyond those indicated in the operational sections of this data sheet is not implied.

Electrical Characteristics

Parameter	Conditions	Symbol	Min	Typ	Max	Units
Output Characteristics @ 25°C						
Open Circuit Voltage	Direct Sun (6000 lux)	V_{OC}	-	8.5	-	V
	High Intensity Lamp	V_{OC}	-	10	-	V
Short Circuit Current	Direct Sun (6000 lux)	I_{SC}	-	50	-	μA

PERFORMANCE DATA*

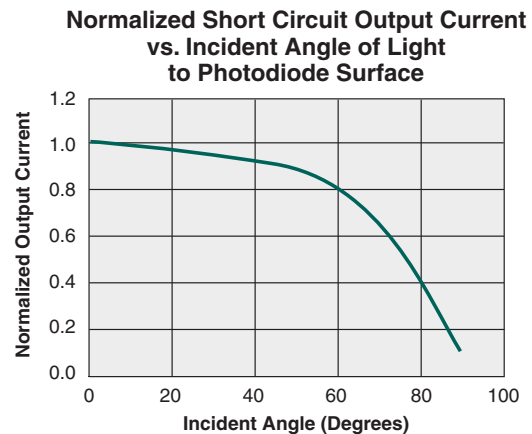
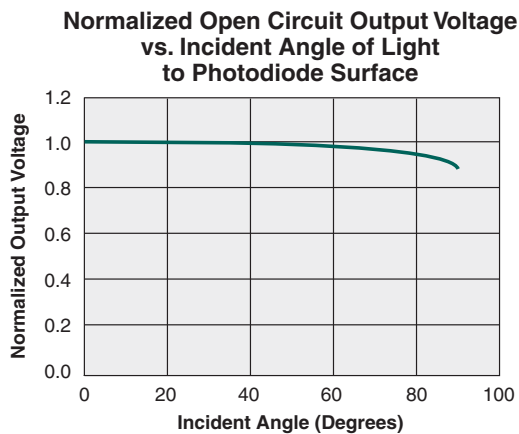
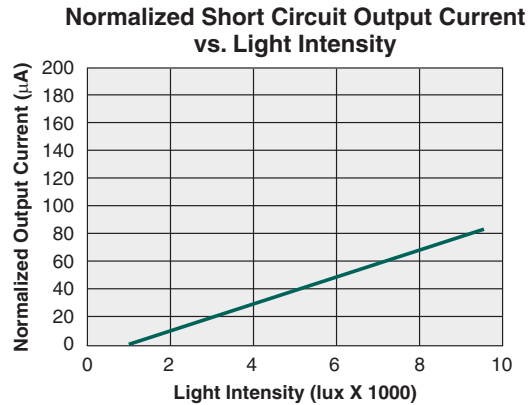
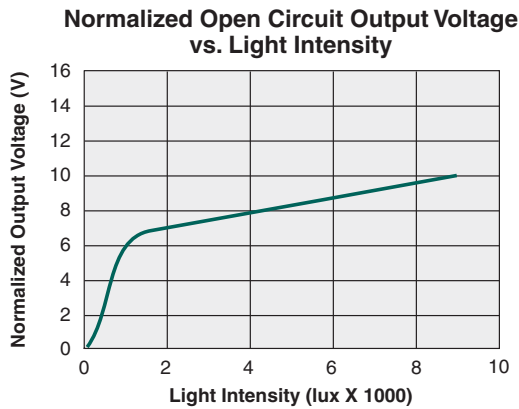

*The Performance data shown in the graphs above is typical of device performance. For guaranteed parameters not indicated in the written specifications, please contact our application department.

Manufacturing Information

Moisture Sensitivity



All plastic encapsulated semiconductor packages are susceptible to moisture ingress. IXYS Integrated Circuits Division classified all of its plastic encapsulated devices for moisture sensitivity according to the latest version of the joint industry standard, **IPC/JEDEC J-STD-020**, in force at the time of product evaluation. We test all of our products to the maximum conditions set forth in the standard, and guarantee proper operation of our devices when handled according to the limitations and information in that standard as well as to any limitations set forth in the information or standards referenced below.

Failure to adhere to the warnings or limitations as established by the listed specifications could result in reduced product performance, reduction of operable life, and/or reduction of overall reliability.

This product carries a **Moisture Sensitivity Level (MSL) rating** as shown below, and should be handled according to the requirements of the latest version of the joint industry standard **IPC/JEDEC J-STD-033**.

Device	Moisture Sensitivity Level (MSL) Rating
CPC1832N	MSL 3

ESD Sensitivity



This product is **ESD Sensitive**, and should be handled according to the industry standard **JESD-625**.

Reflow Profile

This product has a maximum body temperature and time rating as shown below. All other guidelines of **J-STD-020** must be observed.

Device	Maximum Temperature x Time
CPC1832N	260°C for 30 seconds

Board Wash

IXYS Integrated Circuits Division recommends the use of no-clean flux formulations. However, board washing to remove flux residue is acceptable, and the use of a short drying bake may be necessary. Chlorine-based or Fluorine-based solvents or fluxes should not be used. Cleaning methods that employ ultrasonic energy should not be used.



MECHANICAL DIMENSIONS

CPC1832N

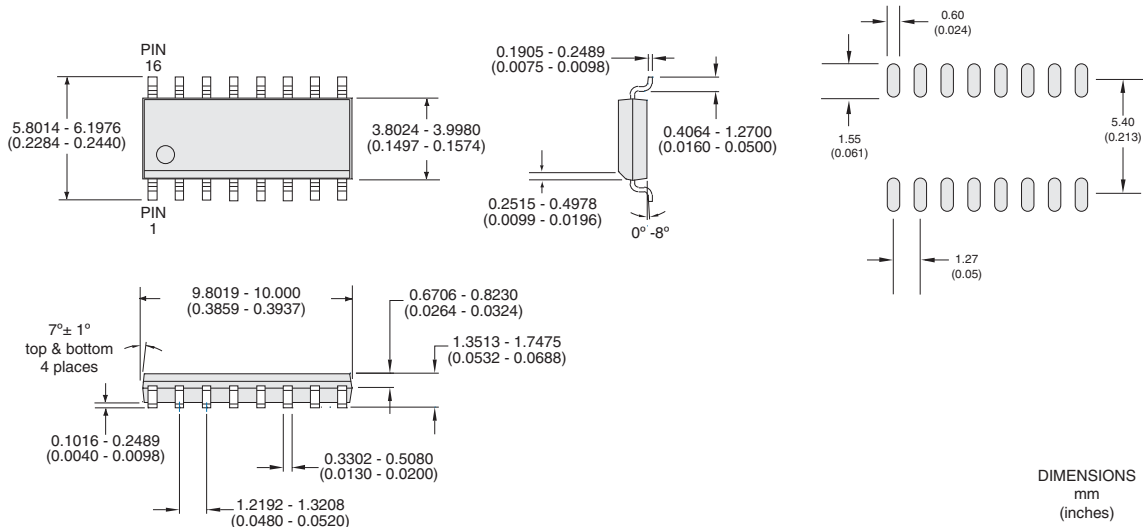

CPC1832NTR Tape & Reel

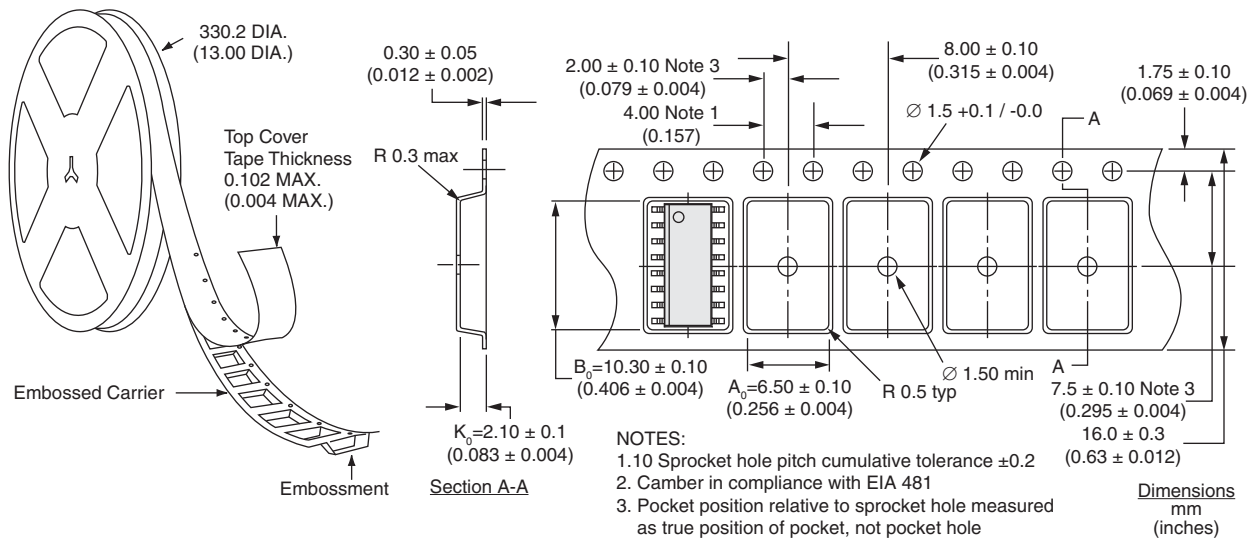

For additional information please visit our website at: www.ixysic.com

IXYS Integrated Circuits Division makes no representations or warranties with respect to the accuracy or completeness of the contents of this publication and reserves the right to make changes to specifications and product descriptions at any time without notice. Neither circuit patent licenses nor indemnity are expressed or implied. Except as set forth in IXYS Integrated Circuits Division's Standard Terms and Conditions of Sale, IXYS Integrated Circuits Division assumes no liability whatsoever, and disclaims any express or implied warranty, relating to its products including, but not limited to, the implied warranty of merchantability, fitness for a particular purpose, or infringement of any intellectual property right.

The products described in this document are not designed, intended, authorized or warranted for use as components in systems intended for surgical implant into the body, or in other applications intended to support or sustain life, or where malfunction of IXYS Integrated Circuits Division's product may result in direct physical harm, injury, or death to a person or severe property or environmental damage. IXYS Integrated Circuits Division reserves the right to discontinue or make changes to its products at any time without notice.