



Chipsmall Limited consists of a professional team with an average of over 10 year of expertise in the distribution of electronic components. Based in Hongkong, we have already established firm and mutual-benefit business relationships with customers from,Europe,America and south Asia,supplying obsolete and hard-to-find components to meet their specific needs.

With the principle of “Quality Parts,Customers Priority,Honest Operation,and Considerate Service”,our business mainly focus on the distribution of electronic components. Line cards we deal with include Microchip,ALPS,ROHM,Xilinx,Pulse,ON,Everlight and Freescale. Main products comprise IC,Modules,Potentiometer,IC Socket,Relay,Connector.Our parts cover such applications as commercial,industrial, and automotives areas.

We are looking forward to setting up business relationship with you and hope to provide you with the best service and solution. Let us make a better world for our industry!



Contact us

Tel: +86-755-8981 8866 Fax: +86-755-8427 6832

Email & Skype: info@chipsmall.com Web: www.chipsmall.com

Address: A1208, Overseas Decoration Building, #122 Zhenhua RD., Futian, Shenzhen, China



Inner Boards

The six available Inner Boards are shown below. Inner Boards can be mounted in slot 1 or slot 2 of a CQM1H-CPU51 or CQM1H-CPU61 CPU. (Some Inner Boards must be mounted in either slot 1 or slot 2.)

NOMENCLATURE

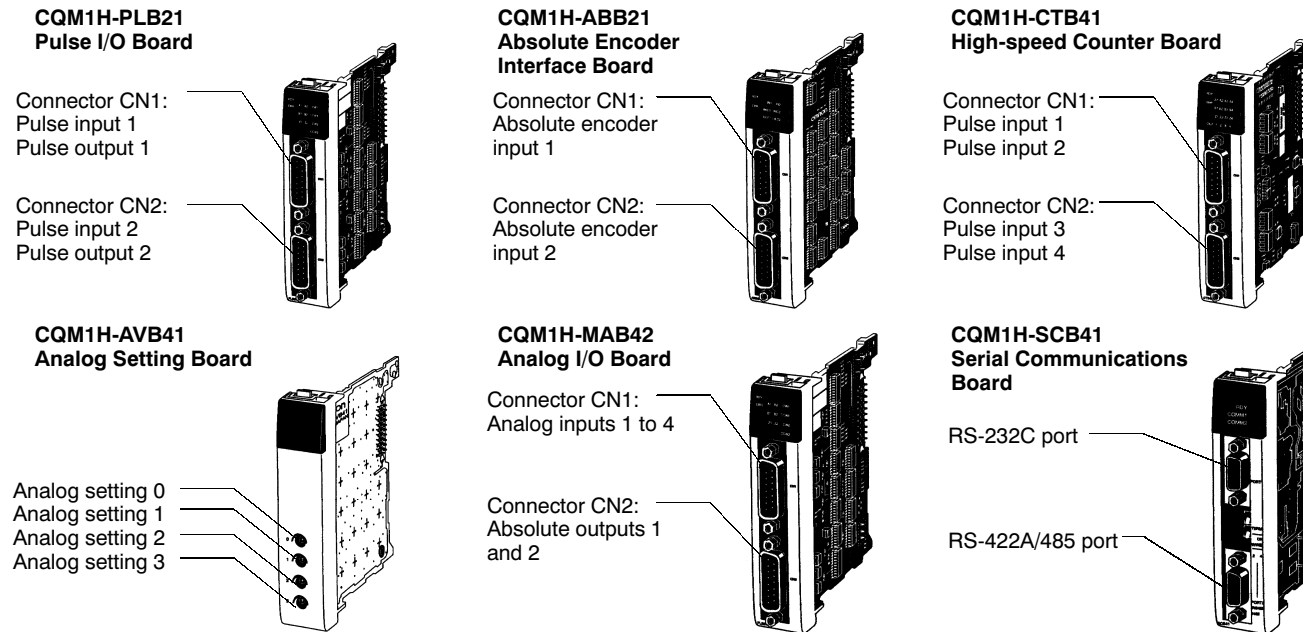

OVERVIEW

Name	Specifications	Model	Slot 1 (left slot)	Slot 2 (right slot)
High-speed counter board	Pulse inputs (high-speed counter): 4 points (50 kHz/500 kHz switchable) External outputs: 4 points	CQM1H-CTB41	Yes	Yes
Pulse I/O board	Pulse inputs (high-speed counter): 2 points (single-phase: 50 kHz, phase difference: 25 kHz) Pulse outputs: 2 points (50 kHz), fixed duty factor and variable duty factor supported	CQM1H-PLB21	No	Yes
Absolute encoder interface board	Encoder (binary gray code) inputs: 2 points (4 kHz)	CQM1H-ABB21		
Analog setting board	Analog settings: 4 points	CQM1H-AVB41	Yes (Install in either but not in both slots.)	
Analog I/O board	Four inputs: 0 to 5 V, 0 to 10 V, -10 to +10 V, 0 to 20 mA Two outputs: 0 to 20 mA, -10 to +10 V	CQM1H-MAB42	No	Yes
Serial communications board	One RS-232C port and one RS-422A/485 port	CQM1H-SCB41	Yes	No

CONFIGURATION

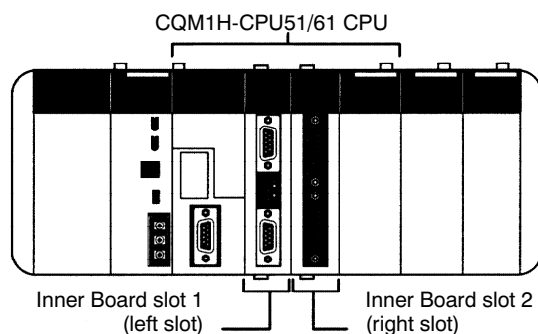

High-speed Counter Inner Board

The High-speed Counter Board is an Inner Board that counts up to 4 high-speed pulse inputs at up to 500 kHz, and can perform tasks according to the number of pulses counted.

CQM1H-CTB41

- Can count 4-axis high-speed pulses at up to 500 kHz.
- Provides 4 external outputs on the Board.
- Both linear and ring counting modes are supported.
- The input can be a voltage input or an RS-422A line driver input.
- Three input modes are available: differential phase mode, up/down mode, and pulse + direction mode
- The counters can be set to record the present values in decimal or hexadecimal.

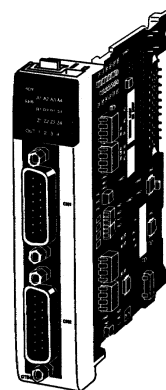

■ CONFIGURATION

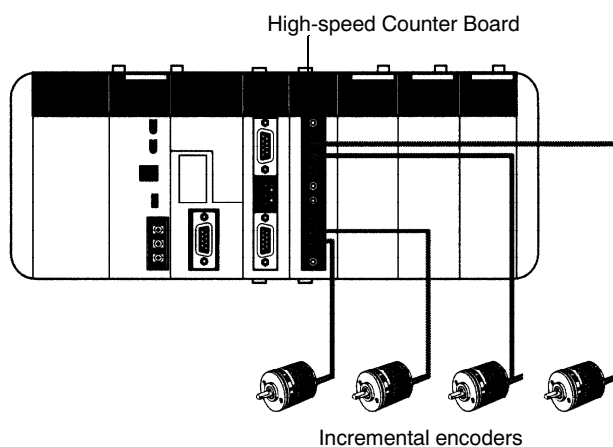

■ SPECIFICATIONS

General

Item	Specification
Model number	CQM1H-CTB41
Applicable CPUs	CQM1H-CPU51/61
Applicable Omron incremental rotary encoders	NPN open collector output: E6B2-CWZ6C, E6C2-CWZ6C (DC 12-24) Line-driver output: E6B2-CWZ1X, E6C2-CWZ1X
Mounting location/No. of Boards	Maximum of two Boards can be mounted simultaneously in slots 1 and 2.
Pulse inputs	4 inputs
External outputs	4 outputs
Current consumption (supplied from Power Supply Unit)	400 mA max., 5 VDC
Dimensions	25 × 110 × 107 mm (W × H × D)
Weight	90 g max.
Standard accessories	Plugs: XM2D-1501 (OMRON) × 2 Hoods: XM2S-1511 (OMRON) × 2

High-speed Counter Inner Board

Pulse Input Functions

Item		Specification		
Number of counters		4 counters (4 ports)		
Input modes (Set in the PLC Setup.)		Differential phase inputs	Up/Down pulse inputs	Pulse/Direction inputs
Input method		Switching between inputs using phase difference multiples of 1x, 2x, or 4x. (Set in the PLC Setup.)	Two single-phase inputs	Single-phase pulse and direction inputs
Count frequency (Set for each port in the PLC Setup.)		25 kHz (default) or 250 kHz	50 kHz (default) or 500 kHz	50 kHz (default) or 500 kHz
Count values		Linear counting: -8388608 to 8388607 BCD, F8000000 to 07FFFFFF Hex Ring counting: 00000000 to 08388607 BCD, 00000000 to 07FFFFFF Hex		
Control method	Target value comparison	Up to 48 target values and external/internal output bit patterns registered.		
	Range comparison	Up to 16 upper limits, lower limits, and external/internal output bit patterns registered.		

Pulse Input Ratings

Item		Specification			
Number of pulse inputs		4 inputs (Ports 1 to 4 = High-speed counters 1 to 4)			
Signals		Encoder inputs A and B; pulse input Z			
Input voltage		Switched by means of input voltage switch on the Board (Specified separately for phases A, B, and Z.)			
		24 VDC \pm 10%		RS-422A line driver (AM26LS31 or equivalent)	
		Phase A and B	Phase Z	Phase A and B	Phase Z
Input current		5 mA typical	8 mA typical	10 mA typical	13 mA typical
ON voltage		19.6 VDC min.	18.6 VDC min.	—	—
OFF voltage		4.0 VDC min.	4.0 VDC min.	—	—

External Output Ratings

Item		Specification
Number of external outputs		4 transistor outputs (The four outputs are set together as sinking or sourcing outputs in the PLC Setup.)
Function		The target comparison or range comparison results of high-speed counters 1 to 4 output four user-defined 4-bit external bit patterns (bits 08 to 11 of either IR 208 to IR 211 or IR 240 to IR 243). An OR is taken of corresponding bits in these four bit patterns, and the result is output on external outputs 1 to 4.
External power supply		5 to 24 VDC \pm 10%
Switching capacity		16 mA/4.5 VDC to 80 mA/26.4 V
Leakage current		0.1 mA max.
Residual voltage		0.8 V max.
Response time		ON response: 0.1 ms max.; OFF response: 0.4 ms max.

Pulse I/O Inner Board

The Pulse I/O Board is an Inner Board that supports two pulse inputs and two pulse outputs.

CQM1H-PLB21

Pulse Inputs

The two pulse inputs to high-speed counters count pulses at up to 50 kHz (signal phase) or 25 kHz (differential phase). Interrupt can be created based on the counter present values (PV).

Interrupts

The Board can execute an interrupt subroutine when the counter PV matches a specified target value (target value comparison) or falls within a specified comparison range (range comparison.)

Pulse Outputs 1 and 2

Two 10 Hz to 50 kHz pulses can be output. Both fixed and variable duty factors can be used.

- The fixed duty factor can be used to change the output frequency (accelerate or decelerate) from 10 Hz to 50 kHz smoothly.
- The variable duty factor performs using a duty factor ranging from 1% to 99%. Variable duty factor pulses can be used for applications such as time-proportional control.

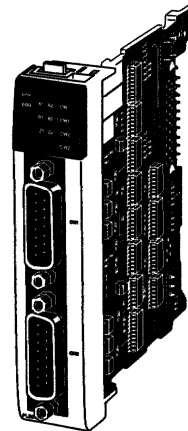

SYSTEM CONFIGURATION

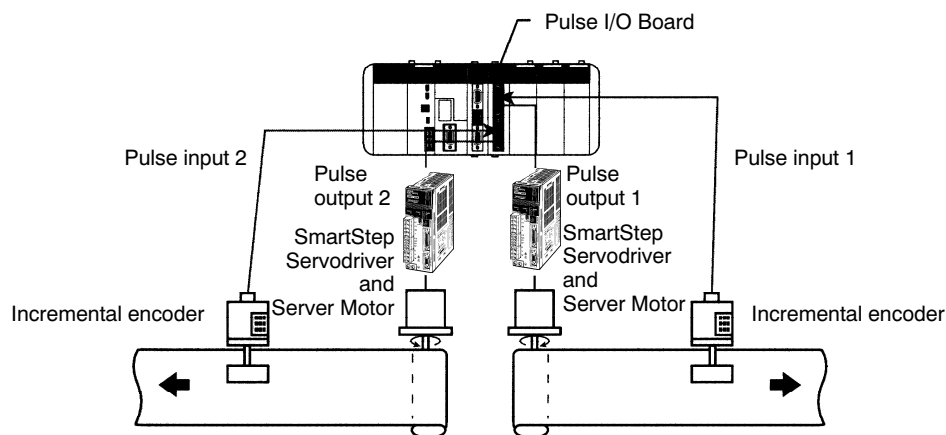

SPECIFICATIONS

General

Item	Specification
Model number	CQM1H-PLB21
Applicable CPUs	CQM1H-CPU51/61
Applicable Omron incremental rotary encoders	NPN open collector output: E6B2-CWZ6C (DC 5-24), E6C2-CWZ6C (DC 5-24), E6D-CWZ2C (DC12), E6A2-CWZ3C (DC5-12)
Mounting locations/No. of Boards	One in Inner Board slot 2 (right slot)
Pulse inputs	2 inputs
Pulse outputs	2 outputs
Current consumption (Supplied from Power Supply Unit)	5 VDC, 160 mA max.
Dimensions	25 × 110 × 107 mm (W × H × D)
Weight	90 g max.
Standard accessories	Two XM2D-1501 Plugs and two XM2S-1511 Hoods (OMRON)

Pulse I/O Inner Board

Pulse Input Function

Item		Specification		
Number of counters		2 counters (ports)		
Input Modes (Set for each port in the PLC Setup.)		Differential phase input	Pulse/Direction input	Up/Down pulse input
Input method		Phase difference multiple of 4 (Fixed)	Single-phase pulse + direction	Single-phase input x 2
Count frequency		25 kHz	50 kHz	50 kHz
Count values		Linear counting: -8388608 to 8388607 BCD Ring counting: 00000000 to 00064999 BCD		
Control method	Target value comparison	Register up to 48 target values and interrupt subroutine numbers.		
	Range comparison	Register up to 8 upper limits, lower limits, and interrupt subroutine numbers.		

Pulse Input Ratings

Item		Specification			
Number of pulse inputs		2 inputs (Ports 1 and 2 = Pulses 1 and 2)			
Signal names		Encoder input A, encoder input B, pulse input Z			
Input voltage		Switched by means of connector pins (Can be specified separately for phases A, B, and Z.)			
		12 VDC±10%		24 V DC±10%	
Input current	Phases A and B	Phase Z	Phases A and B	Phase Z	
	5 mA typical	12 mA typical	5 mA typical	12 mA typical	
ON voltage		10.2 VDC min.		20.4 VDC min.	
OFF voltage		3.0 VDC min.		4.0 VDC min.	

Pulse Output

Pulse Output Function

Pulse output function is determined by the output method, as indicated below.

Item	Fixed duty factor			Variable duty factor
	Without trapezoidal acceleration/deceleration	Same acceleration/deceleration rates	Separate acceleration/deceleration rates	
Instruction	PULS(65)/SPED(64)	PLS2(—)	PULS(65)/ ACC(—)	PWM(—)
Output frequency	10 Hz to 50 kHz (10 Hz to 20 kHz for stepping motor)	0 Hz to 50 kHz	100 Hz to 50 kHz	91.6 Hz, 1.5 kHz, 5.9 kHz
Output frequency pitch	1 or 10 Hz	10 Hz		—
Duty factor	50% fixed			1 to 99%
Number of output pulses	1 to 16,777,215			—
Acceleration/ deceleration rate	—	10 Hz to 2 kHz (every 4.08 ms)		—

Output Ratings

Item		Specification
Number of pulse outputs		2 outputs (Ports 1 and 2 = Pulse outputs 1 and 2)
Signal names		CW and CCW pulse output
Max. output frequency		50 kHz (20 kHz with stepping motor connected.)
External power supply		5 VDC±5% 30 mA min.; 24 VDC +10%/–15% 30 mA min.
Max. switching capacity		NPN open collector, 30 mA/5 to 24 VDC±10%
Min. switching capacity		NPN open collector, 7 mA/5 to 24 VDC±10%
Leakage current		0.1 mA max.
Residual voltage		0.4 V max.

Absolute Encoder Interface Inner Board

The Absolute Encoder Interface Board is an Inner Board that allows position data to be directly input from absolute rotary encoders.

CQM1H-ABB21

Absolute High-speed Counter

The Absolute Encoder Interface Board reads binary gray codes (inverted binary codes) input from an absolute encoder at a maximum counting rate of 4 kHz, and can perform interrupt processing according to the input values.

Interrupts

An interrupt subroutine can be executed when the PV (present value) of the absolute high-speed counter matches a specified target value (target value comparison) or falls within a specified comparison range (range comparison.)

Note: When an absolute encoder is used the position data can be retained even during power interruptions, so it isn't necessary to perform an origin return when power is returned. In addition, the origin compensation function allows the user to specify any position as the origin.

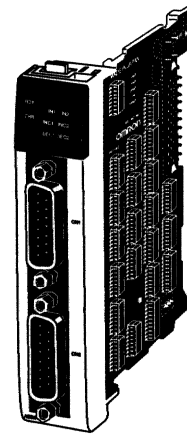

SYSTEM CONFIGURATION

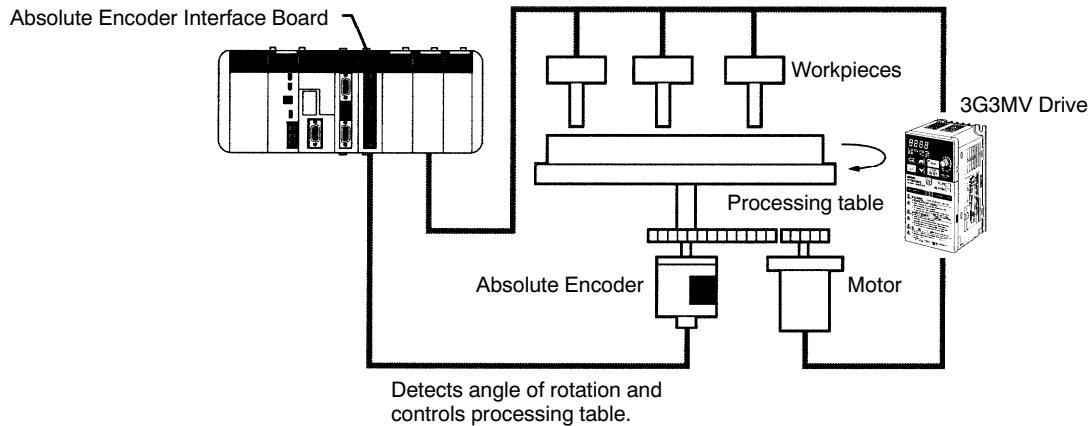

SPECIFICATIONS

General

Item	Specification
Model number	CQM1H-ABB21
Applicable CPU	CQM1H-CPU51/61
Applicable Omron absolute encoders	E6F-AG5C-C, E6CP-AG5C-C, E6C2-AG5C-C
Mounting locations and number of Boards	1 Board can be mounted in slot 2.
Absolute Encoder inputs	2 inputs
Current consumption (supplied from Power Supply Unit)	5 VDC, 150 mA max.
Dimensions	25 × 110 × 107 mm (W × H × D)
Weight	90 g max.
Standard accessories	Plugs: XM2D-1501 (OMRON) × 2 Hoods: XM2S-1511 (OMRON) × 2

(Specifications continue on the next page.)

Absolute Encoder Interface Inner Board

Absolute Encoder Input Ratings

Item	Specification	
Number of inputs	Two inputs	
Input code	Binary gray code	
Operating modes	BCD Mode or 360° Mode (Set in PLC Setup.)	
Resolutions	8-bit, 10-bit, or 12-bit (Set in PLC Setup.)	
Origin compensation	Supported. (Current position can be designated as origin). Compensation is set in PLC Setup.	
Counting rate	4 kHz max.	
Control methods	Target value comparison	Register up to 48 target values and interrupt subroutine numbers.
	Range comparison	Register up to 8 upper limits, lower limits, and interrupt subroutine numbers.

Pulse Input Ratings

Item	Specification
Input voltage	24 VDC +10%, -15%
Input impedance	5.4 kΩ
Input current	4 mA typical
ON voltage	16.8 VDC min.
OFF voltage	3.0 VDC max.

Serial Communications Inner Board

The Serial Communications Board is an Inner Board equipped with 2 ports that can be used to connect host computers, Programmable Terminals, external serial devices, or Programming Devices other than a Programming Console.

CQM1H-SCB41

- Unlike the CPU's built-in ports, the Serial Communications Board supports the protocol macro function which can provide communications between the CQM1H and external serial devices.
- The Serial Communications Board has 2 ports: an RS-232C port and an RS-422A/485 port. The RS-422A/485 port supports 1:N connections (protocol macro or NT Link in 1:N mode) without an adapter.

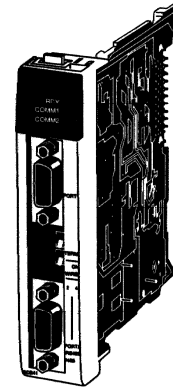

■ SYSTEM CONFIGURATION

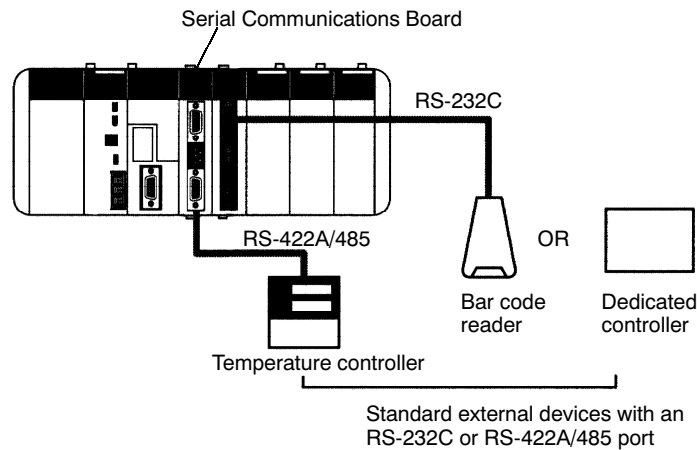

■ COMMUNICATIONS MODES

The following 6 communications modes can be set independently for the two Serial Communications Board ports.

- Host Link
Communications with a host computer, Programming Device, or Programmable Terminal
- No-protocol
No-protocol communications (TXD and RXD) with standard external devices
- Protocol macro
Communications can be tailored to the external serial device's communications protocol
- 1:1 Data Link
Data link with a CQM1H, CQM1, or other C-series PLC
- NT Link in 1:N mode
One-to-one or one-to-N communications with Programmable Terminals
- NT Link in 1:1 mode
One-to-one communications with Programmable Terminal

■ COMMUNICATIONS PORTS AND SERIAL COMMUNICATIONS MODES

Serial communications protocol	CQM1H-SCB41 Serial communications board	
	RS-232C port (port 1)	RS-422A/485 port (port 2)
Peripheral bus or Programming Console bus	No	No
Host Link (SYSMAC WAY)	YES	YES (See Note 1)
Protocol macro	YES	YES
No-protocol	YES	YES (See Note 1)
1:1 Data Link	YES	YES (See Note 1)
NT Link in 1:1 mode	YES (See Note 2)	YES (See Note 2)
NT Link in 1:N mode	YES (See Note 2)	YES (See Note 2)

Note: 1. The 4-wire method must be used if the RS-422A/485 port is used in Host Link, No-protocol, or 1:1 Data Link mode.
 2. A Programmable Terminal's Programming Console function cannot be used.

■ SPECIFICATIONS

Item	Specification	
Model	CQM1H-SCB41	
Unit classification	CQM1H-series Inner Board	
Applicable CPUs	CQM1H-CPU61/51	
Mounting locations and number of Boards	1 Board can be mounted in slot 1.	
Serial Communications ports	Port 1	RS-232C: 19.2 kbps max., 15 m max.
	Port 2	RS-422A/485: 19.2 kbps max., 500 m max.
Protocols	Port 1	Each port can be set independently to Host Link, No-protocol, Protocol macro, 1:1 Data Link, NT Link in 1:N mode, or NT Link in 1:1 mode.
	Port 2	
Current consumption	200 mA max.	
Dimensions	32 × 131 × 107 mm (W × H × D)	
Weight	90 g max.	
Standard accessories	Plugs: XM2SA-0901 (OMRON) × 1 Hoods: XM2SA-0911 (OMRON) × 1 (ESD)	

■ PROTOCOL MACRO

Protocol macro provides a way to create data communications protocols that meet the specifications of external devices with serial communications ports (half-duplex, start-stop sync only). The protocol macro is made on the CX-Protocol Support Software and then recorded in the Serial Communications Board, where it can be executed at any time using the PMCR instruction in the CPU's ladder program.

Standard system protocols are also provided with the CX-Protocol and Serial Communications Board for easy communications with OMRON components, such as Temperature Controllers, Intelligent Signal Processors, Bar Code Readers, and Modems. The standard system protocols can also be modified to communicate with virtually any third-party serial device using the CX-Protocol.

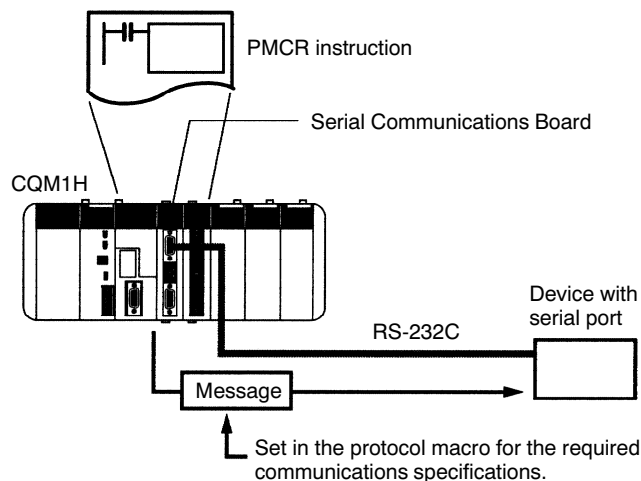

Analog I/O Inner Board

The Analog I/O Board is an Inner Board with four analog inputs and two analog outputs.

CQM1H-MAB42

The signal ranges that can be used for each of the four analog inputs are -10 to +10 V, 0 to 10 V, 0 to 5 V, and 0 to 20 mA. Each input's signal range can be set independently.

The signal ranges that can be used for each of the two analog output points are -10 to +10 V and 0 to 20 mA. Each output's signal range can be set independently.

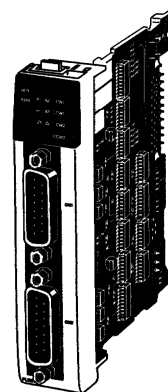

SYSTEM CONFIGURATION

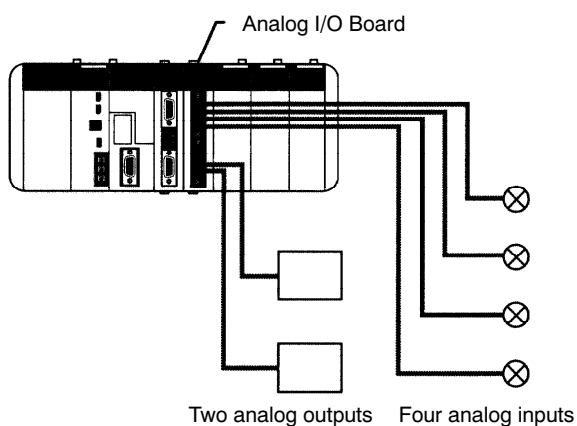

SPECIFICATIONS

General

Item	Specification
Model number	CQM1H-MAB42
Applicable CPUs	CQM1H-CPU51/61
Mounting locations and number of Boards	1 Board in Inner Board slot 2 (right slot)
Analog inputs	4 inputs
Analog outputs	2 outputs
Current consumption (Supplied from Power Supply Unit)	400 mA max., 5 VDC
Dimensions	25 × 110 × 107 mm (W × H × D)
Weight	100 g max.
Standard accessories	Plugs: XM2D-1501 (OMRON) × 2 Hoods: XM2S-1511 (OMRON) × 2

Analog I/O Inner Board

Analog Input Ratings

Item	Specification	
Input signals	Voltage inputs	Current inputs
Number of analog inputs	4 inputs	
Input signal ranges (See Note 1)	-10 to 10 V 0 to 10 V 0 to 5 V	0 to 20 mA
A/D conversion time (See Note 2)	1.7 ms max./point	
Resolution	1/4,096	
A/D conversion output data	12-bit binary data -10 to +10 V: F800 to 07FF Hex 0 to 10 V, 0 to 5 V: 0000 to 0FFF Hex	12-bit binary data 0 to 20 mA: 0000 to 0FFF Hex
External input impedance	1 M Ω typical	250 Ω typical
Absolute maximum rated input	± 15 V	± 30 mA
Overall precision (See Note 3)	23 \pm 2°C	$\pm 0.5\%$ of FS
	0 to 55°C	$\pm 1.0\%$ of FS

- Note: 1. Separate input signal ranges can be set for each input.
 2. The A/D conversion time is the time taken for an analog signal to be stored in memory as digital data. At least one cycle is required to transfer the data to the CPU.
 3. The overall precision is the precision with respect to full scale.
 4. The CQM1H-MAB42 Analog I/O Board, unlike the CQM1-AD041, does not have a hardware average processing function. If averaging of data is required, use the CPU's data averaging instruction (AVG).

Analog Output Ratings

Item	Specification	
Output signals	Voltage outputs	Current outputs
Number of analog outputs	2 outputs	
Output signal ranges (See Note 1)	-10 to 10 V	0 to 20 mA
D/A conversion time (See Note 2)	1.7 ms max./2 points	
Resolution	1/4,096	1/2,048
Set output data	12-bit binary data -10 to +10 V: F800 to 07FF Hex	11-bit binary data 0 to 20 mA: 0000 to 07FF Hex
Allowable external output load resistance	2 K Ω min.	350 Ω max.
Overall precision (See Note 3)	23 \pm 2°C	$\pm 0.5\%$ of FS
	0 to 55°C	$\pm 1.0\%$ of FS

- Note: 1. Separate output signal ranges can be set for each output.
 2. The D/A conversion time is the time taken for the output data set in memory to be converted to analog signals and output. At least one cycle is required to transfer the data in the CPU to the Analog I/O Board.
 3. The overall precision is the precision with respect to full scale.

Analog Setting Board

The Analog Setting Board is an Inner Board that provides four variable resistor adjustments. The settings on the four adjustments are stored in the analog setting words.

By using the Analog Setting Board, an operator can, for example, set the value of a timer instruction using an analog adjustment, and thereby slightly speed up or slow down the speed or timing of a conveyor belt simply by turning an adjustment screw with a screwdriver, removing the need for a Programming Device.

CQM1H-AVB41

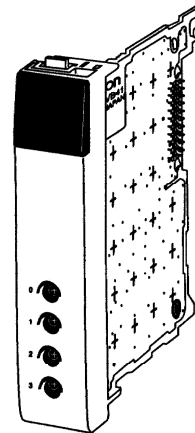

■ USING THE ANALOG TIMER

The following example shows the 4-digit BCD setting (0000 to 0200) stored in IR 220 to IR 223 being used as a timer setting.

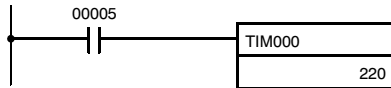

The setting of TIM 000 is set externally in IR 220. (TIM 000 is executed using the SV set with analog adjustment 0.)

■ SPECIFICATIONS

Item	Specification
Model number	CQM1H-AVB41
Applicable CPUs	CQM1H-CPU51/61
Mounting locations and number of Boards	1 Board can be mounted in either slot 1 or slot 2. Note: Two Analog Setting Boards cannot be used at the same time.
Settings	4 analog (variable resistor) adjustment screws on front panel (Adjustable using Phillips screwdriver.) The settings of adjustments 0 to 3 are stored as 4-digit BCD values between 0000 and 0200 in IR 220 to IR 223 respectively.
Current consumption (supplied from Power Supply Unit)	10 mA max., 5 VDC
Dimensions	25 × 110 × 107 mm (W × H × D)
Weight	60 g max.

Communication Modules

OVERVIEW

Classification	Name	Model	Specifications	
Controller network	Controller Link module	CQM1H-CLK21	Number of data link words: 1000 words per node Message length: 2,012 bytes max. (including the header) Communications cycle time: 2 Mbps at 500 m Max. transmission distance: 1 km Max. slaves per master: 31 slaves per master module	
Field network	CompoBus/S master module	CQM1-SRM21-V1	Number of I/O points per Master: 128 (64 inputs/64 outputs) Communications cycle time: 0.5 ms min. Max. transmission distance: 500 m in long-distance mode 100 m in high-speed mode Max. slaves per master: 32	
	SYSMAC BUS	G730 remote master	CQM1-G7M21	Connects CQM1H to G730 SYSMAC BUS remote I/O blocks; 64 I/O max. on the master; 32 inputs or outputs max. on expansion modules Number of I/O points per Master: 128 Communications cycle time: 187.5 kbps Max. transmission distance: 200 m One master and two expansions allowed per system
		Input expansion module	CQM1-G7N11	
		Output expansion module	CQM1-G7N01	
	DeviceNet I/O link module	CQM1-DRT21	Number of I/O points: 16 inputs and 16 outputs	
	AS-Interface master module	CQM1-ARM21	Number of I/O points: 248 (124 inputs/124 outputs; 4 inputs/4 outputs per slave) Communications cycle time: 5.148 ms min. Max. transmission distance: 100 m; 300 m with 2 repeaters Max. slaves per master: 31 slaves per master module	
Profibus-DP I/O link module	CQM1-PRT21	Number of I/O points: 128 inputs/128 outputs		

Controller Link Module

The Controller Link is a communications network that can send and receive large data packets flexibly and easily among the OMRON CQM1H-series, C200HX/HG/HE, CS1-series, CVM1, and CV-series PLCs.

Controller Link supports data links that enable data sharing and a message service that enables sending and receiving data when required. Data link areas can be freely set to create a flexible data link system and effectively use data areas.

- High-capacity, flexible, and efficient data links
- Message service can transfer large quantities of data.
- Simple twisted-pair wiring
- Easily connects different PLC models and computers.
- Flexible inter-network connections
- Robust error-handling functions

CQM1H-CLK21

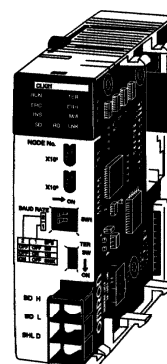

Data Links

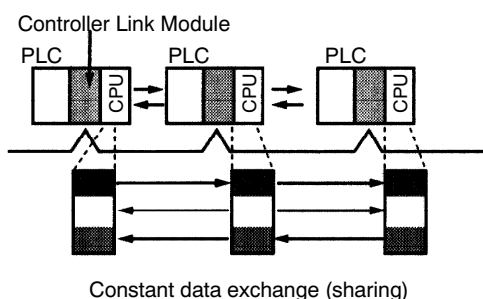

Message Service

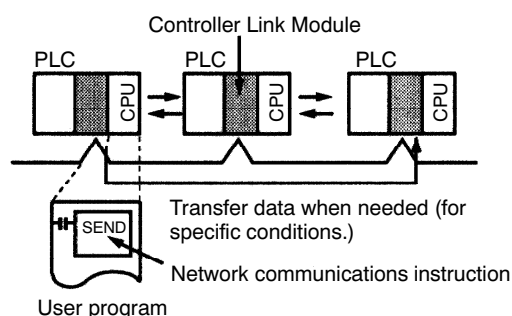

■ SPECIFICATIONS

General

Item	Specification
Model number	CQM1H-CLK21
Applicable CPUs	CQM1H-CPU51/CPU61
Connection location and number of modules	One module only. The module must be connected between the Power Supply Unit and the CPU.
Current consumption	270 mA, 5 VDC
Dimensions	32 × 110 × 107 mm (W × H × D) (without terminals)
Weight	170 g max.

Communications

Item	Specification
Communications method	N:N token bus
Code	Manchester code
Modulation	Baseband code
Synchronization	Flag synchronization (conforms to HDLC frames)
Transmission path form	Multi-drop bus
Baud rate and maximum transmission distance	The maximum transmission distance varies with the baud rate as follows: 2 Mbps: 500 m 1 Mbps: 800 m 500 kbps: 1 km
Media	Specified shielded twisted-pair cable Number of signal lines: 2, shield line: 1
Maximum number of nodes	32 nodes
Communications functions	Data links and message service
Number of data link words	Transmission area per node: 1,000 words max. Data link area in one CQM1H-series PLC (send/receive): 8,000 words max.
Data link areas	Bit areas (IR, AR, LR, CIO), data memory (DM), and extended data memory (EM)
Message length	2,012 bytes max. (including the header)
RAS functions	Polling node backup function Self-diagnosis function (hardware checking at startup) Echoback test and broadcast test (using the FINS command) Watchdog timer Error log function
Error control	Manchester code check CRC check (CCITT $X^{16} + X^{12} + X^5 + 1$)

CompoBus/S Master Module

The CompoBus/S Master Module supports both a high-speed communications mode and a long-distance communications mode for distributed remote I/O.

CQM1-SRM21-V1

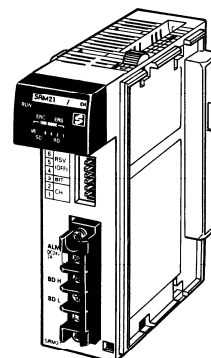

■ SPECIFICATIONS

Communications

Communications protocol		Dedicated CompoBus/S protocol			
Code		Manchester code			
Connection method		Multi-drop, T-type bifurcation (both methods require external terminating resistor)			
Baud rate		750 kbps, 93.75 kbps (selectable with a DIP switch)			
Communications cycle time	High-speed communications mode	0.5 ms (with a maximum number of 8 Input and 8 Output Slaves) 0.8 ms (with a maximum number of 16 Input and 16 Output Slaves)			
	Long-distance communications mode	4.0 ms (with a maximum number of 8 Input and 8 Output Slaves) 6.0 ms (with a maximum number of 16 Input and 16 Output Slaves)			
Cable		Two-conductor cable (VCTF 0.75 x 2 or Belden #9409 cable) or dedicated flat cable (SCA1-4F10)			
Communications distance	High-speed communications mode	Cable type	Trunk line length	Branch line length	Total line length
		VCTF or Belden #9409	100 m max.	3 m max.	50 m max.
		Flat cable SCA1-4F10	30 m max.	3 m max.	30 m max.
	The maximum trunk line and branch length using flat cable can be 100 m and 50 m, respectively, if the number of slaves connected is 16 or less.				
	Long-distance communications mode	Cable type	Trunk line length	Branch line length	Total line length
		VCTF or Belden #9409	500 m max.	6 m max.	120 m max.
Max. number of connectable nodes		32			
Error control		Manchester code, frame length, and parity checks			

Master Unit

Internal current consumption	180 mA max., 5 VDC
Number of I/O points	128 points (64 inputs and 64 outputs), 64 points (32 inputs and 32 outputs), or 32 points (16 inputs and 16 outputs) selectable with a switch.
Number of occupied words	128 points: 4 input words and 4 output words 64 points: 2 input words and 2 output words 32 points: 1 input word and 1 output word
Number of points per node	8 or 4 points (selectable with a switch)
Max. number of connectable Slaves	32 (with 4 points per node)
Status data	Alarm terminal output
Weight	200 g max.

Note: For details about CompoBus/S, refer to the CompoBus/S section in Omron's *Remote I/O and Wiring Solutions Catalog (GC RIO1)*.

■ CONFIGURATION

Connections with Flat Cable

Master

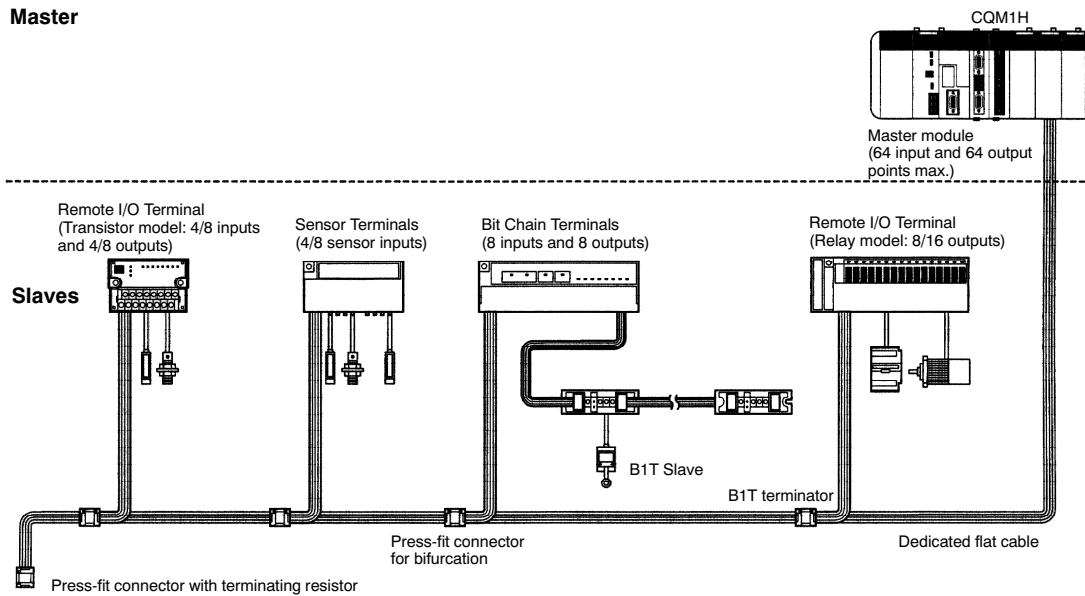

Connections with VCTF or Twisted Pair Cable

Master

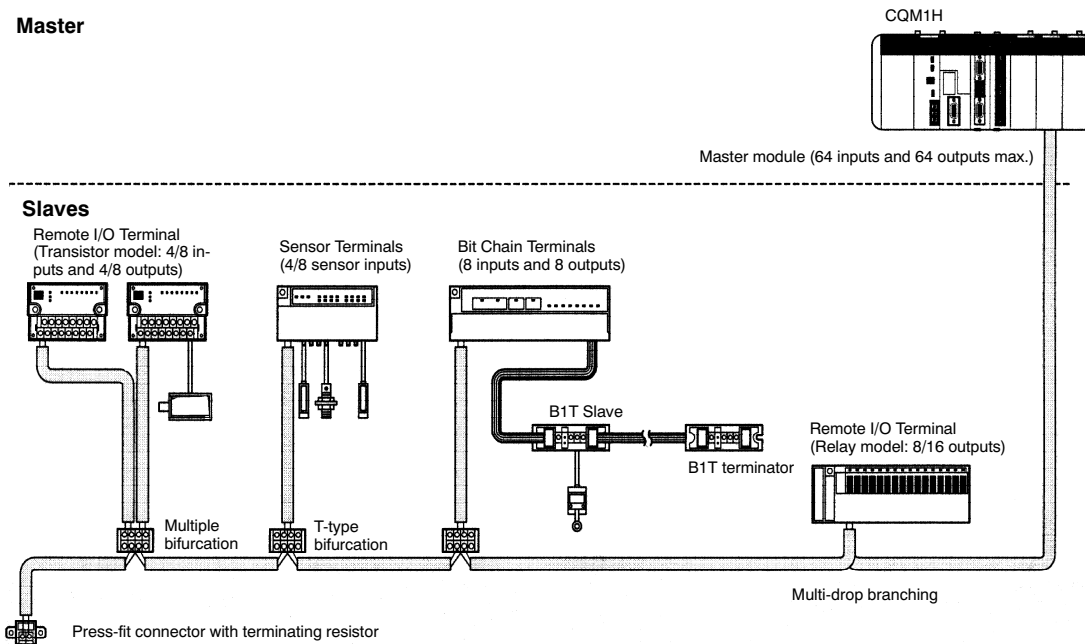

Note: For details about CompoBus/S, refer to the CompoBus/S section in Omron's *Remote I/O and Wiring Solutions Catalog (GC RIO1)*.

SYSMAC BUS Master and Expansion Modules

The SYSMAC BUS Master and Expansion Modules provide reliable remote I/O using G730 relay and transistor I/O blocks.

- Transmission distance up to 200 m at 187.5 kbps
- Reduce I/O wiring back to the controller to a single twisted pair cable
- Master modules connect up to 128 I/O; one master and two expansions allowed per system
- Use G730 transistor and relay input and output blocks shown in the Complementary Products section

CQM1-G7M21 Master and CQM1-G7N□1 Expansion



■ SPECIFICATIONS

Item	Specification		
Model	CQM1-G7M21	CQM1-G7N11	CQM1-G7N01
Description	G730 remote master	Input expansion module	Output expansion module
Max. I/O points	64 max. (32 inputs/32 outputs or 16 inputs/16 outputs, DIP switch selectable)	32 max. (32 or 16 inputs, DIP switch selectable)	32 max. (32 or 16 outputs, DIP switch selectable)
Communications protocol	Dedicated SYSMAC BUS protocol		
Communications method	Two-wire, half-duplex		
Interface	RS-485		
Synchronization	Start-stop		
Baud rate	187.5 kbps		
Cable	Two-conductor cable (VCTF 0.75 x 2 or Belden #9409 cable)		
Communications distance	200 m max.		
Current consumption	80 mA at 5 VDC		

■ CONFIGURATION

The following example shows one master and no expansions. The maximum system consists of one master and two expansion modules per CQM1H CPU. Information on the G730 input and output blocks is shown in the Complementary Products section.

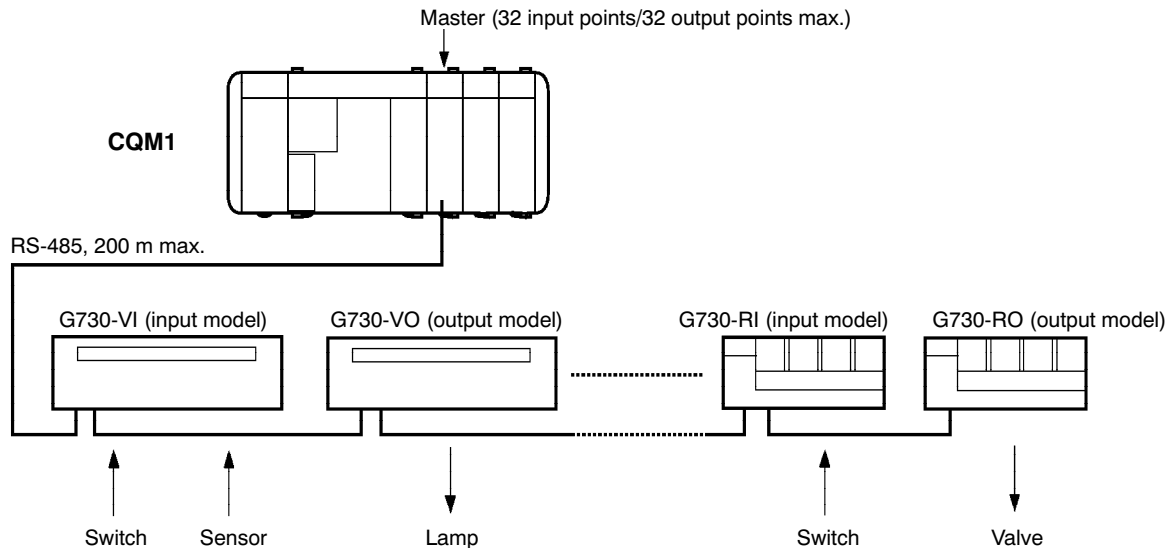

DeviceNet Slave I/O Link Module

This CompoBus/D slave module conforms to the multivendor DeviceNet standards. DeviceNet I/O Link Modules connect one or more CQM1H PLCs to a DeviceNet Master. Each module allows 16 inputs/16 outputs to be mapped as a node.

CQM1-DRT21

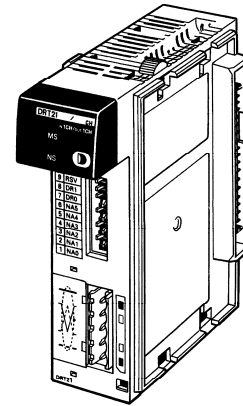

■ SPECIFICATIONS

General

Communications power supply voltage	11 to 25 VDC supplied from the communications connector. (See Note)
Current consumption	Communications: 40 mA max. at 24 VDC Internal circuit: 80 mA max. at 5 VDC
Number of I/O points	32 points (16 inputs/16 outputs)
Number of occupied words	Input: 1 word Output: 1 word
Weight	185 g max.

Note: Refer to the *DeviceNet Operation Manual (W267)* for the communications power supply specifications.

Communications (conforming to DeviceNet standards)

Connection method	Multi-drop, T-type bifurcation (both require external terminating resistor)			
Baud rate	500, 250 or 125 kbps (selectable with a switch)			
Communications cycle time	9.3 ms with 16 Input Slaves (16 inputs) and 16 Output Slaves (16 outputs) at a speed of 500 kbps			
Cable	Dedicated 5-conductor cable (with two signal wires, two power wires, and a shield wire) One XW4B-05C1-H1-D connector is supplied to connect to the module; order another if your cable does not have a DeviceNet connector on the other end.			
Communications distance	Baud rate	Max. network length (See Notes 1 and 2)	Branch line length	Total branch line length
	500 kbps	100 m max.	6 m max.	39 m max.
	250 kbps	250 m max.	6 m max.	78 m max.
125 kbps	500 m max.	6 m max.	156 m max.	
Max. number of connectable nodes	CVM1 or CV series:	64 nodes		
	C200HX/HG/HE:	50 nodes		
	C200HS:	32 nodes		
Error control	CRC errors, node address duplications, scan line checks			

- Note: 1. The maximum network length refers to the distance between two nodes farthest from each other.
2. The communications distance will be 100 m or less if a thin dedicated cable (DCA1-5C10) is used for the trunk line.

■ MEMORY ALLOCATION

Words Allocated by CQM1H Slaves

In CQM1H PLCs, an I/O Link Module is treated just like an I/O Module with one input word and one output word, so word allocation is identical to a standard I/O Module. Words are allocated from the left side of the PLC, beginning with IR 001 for inputs and IR 100 for outputs.

Example

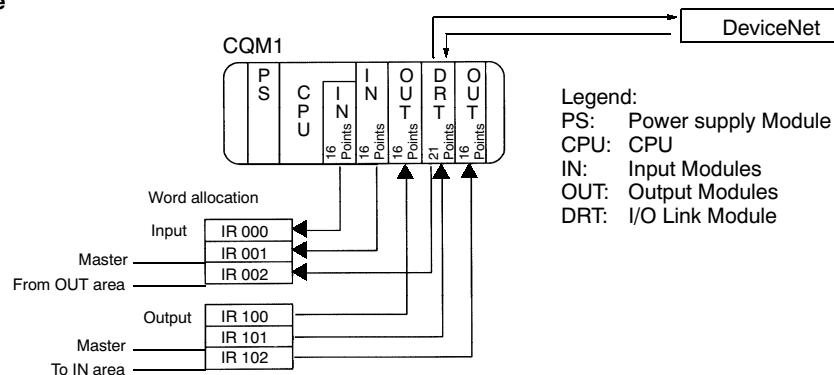

■ CONFIGURATION

System Configuration Example

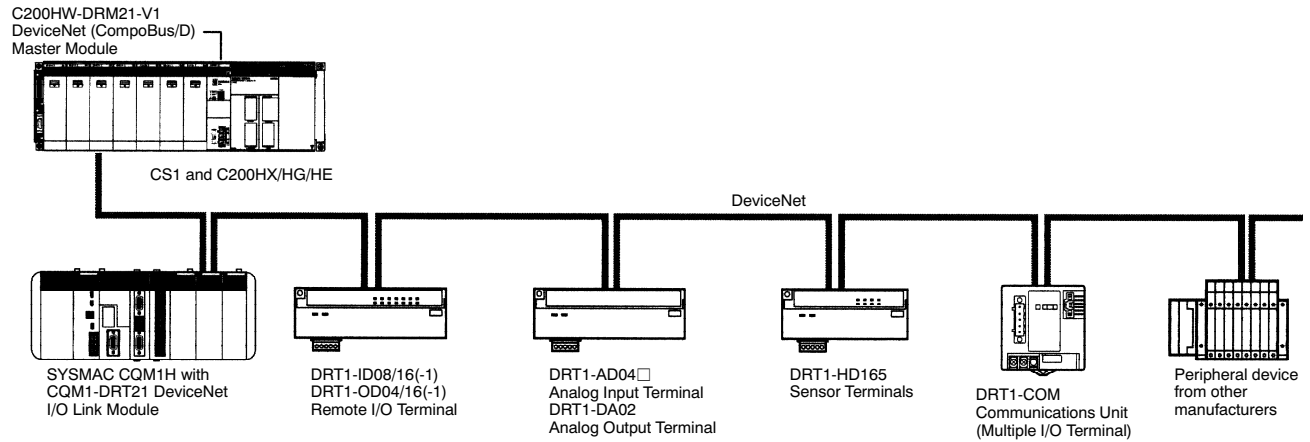

Note: For details on DeviceNet (CompoBus/D), refer to Omron's *DeviceNet Products* catalog (Catalog number: P10FAX1A).

Profibus-DP I/O Link Module

The Profibus-DP I/O link module can be used as an intelligent slave on a Profibus-DP network. It conforms to the EN 50170 Vol. 2 Profibus standard. No PLC settings need to be made. The CQM1-PRT21 can auto-detect all Profibus-DP baud rates from 9.6 Kbit/s to 12 Mbit/s. Also, it can be configured for 2, 4, 6 or 8 words.

CQM1-PRT21



■ SPECIFICATIONS

General

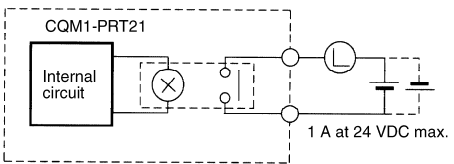
Host PLC system	CQM1, CQM1H
Switch settings	Number of I/O words Motorola/Intel data format Profibus-DP address
LED indicators	Unit status : RUN (green LED), ERR (red LED) Network status : COMM (green LED), BF (red LED) WD OFF (yellow LED), CLEAR (yellow LED) SYNC (yellow LED), FREEZE (yellow LED)
No. of occupied words	Configurable by DIP switches (see note) <ul style="list-style-type: none"> ● 2 words in + 2 words out ● 4 words in + 4 words out ● 6 words in + 6 words out ● 8 words in + 8 words out
I/O refresh time (data exchange with CPU)	Max. 0.16 ms
Current consumption (max)	350 mA at 5 VDC (at CQM1 I/O bus)
Weight	170 g
Storage temperature	-20 to +75°C
Operating temperature	0 to +55°C
Operating humidity	10% to 90% (non-condensing)
EMC compliance	EN50081-2, EN61131-2
Circuit configuration	Communication status output (COMM) terminal 

Note: The CQM1-PRT21 can be mounted to any CQM1- or CQM1H-series CPU. The maximum amount of I/O data that can be exchanged with the CPU depends on the selected CPU type, and on the number and type(s) of any additional I/O unit(s). To operate with the Unit's maximum I/O capacity, a CQM1H-CPU51 or CQM1H-CPU61 is required.

Communication

Applicable standard	EN 50170 vol. 2
Station type	Modular station, max. 1 module Configurable with I/O-modules of 2, 4, 6 or 8 words
Data consistency	By word
Bus connector	9-pin female sub-D connector (RS-485 Profibus connector)
Bus termination	External
Baud rate (auto-detect)	9.6 / 19.2 / 45.45 / 93.75 / 187.5 / 500 kbit/s, 1.5 / 3 / 6 / 12 Mbit/s
Profibus address range	0 to 99, remote setting not supported
Communication cable	Type A (EN 50170 vol. 2)
Minimum slave interval time	0.5 ms
Watchdog base	10 ms, 1 ms selectable by parameter setting
Supported DP functions	<ul style="list-style-type: none"> • Data_Exchange • Slave_Diag • Set_Prm • Chk_Cfg • Global_Control (SYNC, FREEZE, CLEAR) • Get_Cfg • RD_Inp • RD_Outp
Profibus-DP GSD file	OC_054D.GSD

Communication status output

The COMM relay contact output indicates if data exchange with the Profibus-DP master unit is active. This signal can be connected to a PLC input or external signaling device. It is recommended to use this information in the PLC to judge the validity of the received data.

ON state	<ul style="list-style-type: none"> • I/O data exchange with the Profibus-DP master is active
OFF state	<ul style="list-style-type: none"> • PLC power OFF • Fatal error in PLC CPU or I/O bus • No I/O data exchange with Profibus-DP master (check LED indication)
Relay type	OMRON G6H-2F, non-replaceable
Maximum load	1 A at 24 VDC
ON/OFF delay	less than 10 ms
Connector	Phoenix MSTBA 2,5/2-G

AS-Interface Master Module

The ASI module conforms to version 2.04 of the multivender AS International standards. The system requires one master unit to control all data exchanges over the bus. During normal operation, the master cyclically sends output data to all slaves and receives the slaves' input data in return. The maximum number of slaves that an AS-Interface master can exchange data with at any time is 31. The network uses any shielded or unshielded two-wire cable meeting specified requirements.

CQM1-ARM21

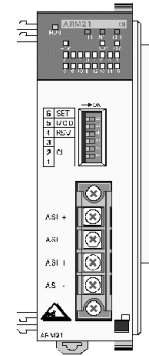

■ SPECIFICATIONS

General

Communications power supply voltage	30.5 VDC supplied from the communications connector. (See note)
Current consumption	Communications: 300 mA max. at 30.5 VDC Internal circuit: 300 mA max. at 5 VDC
Number of I/O points	8 points (4 inputs/4 outputs) per node 248 points max. (124 inputs/124 outputs) with 31 slave units
Number of occupied words	Input: 3 or 8 words, selectable Output: 3 or 8 words, selectable
Weight	Approx. 200 g

Note: Refer to the *AS-Interface Master Unit Operation Manual (W357)* for additional specifications.

Communications (conforming to AS-Interface standards)

Connection method	Star, line, branch lines or tree topology, termination not required.
Baud rate	167 k baud
Communications cycle time	0.4 to 5 ms max., depending on the number of slave units on the network.
Cable	AS-interface "yellow cable" for IP67 protection, or any shielded or unshielded two-wire cable with a cross section of 2 x 1.5 mm ²
Communications distance	100 m per master Up to 300 m using 2 repeaters and additional AS-Interface power supplies
Max. number of connectable nodes	CQM1H: 31 nodes