



Chipsmall Limited consists of a professional team with an average of over 10 year of expertise in the distribution of electronic components. Based in Hongkong, we have already established firm and mutual-benefit business relationships with customers from,Europe,America and south Asia,supplying obsolete and hard-to-find components to meet their specific needs.

With the principle of “Quality Parts,Customers Priority,Honest Operation,and Considerate Service”,our business mainly focus on the distribution of electronic components. Line cards we deal with include Microchip,ALPS,ROHM,Xilinx,Pulse,ON,Everlight and Freescale. Main products comprise IC,Modules,Potentiometer,IC Socket,Relay,Connector.Our parts cover such applications as commercial,industrial, and automotives areas.

We are looking forward to setting up business relationship with you and hope to provide you with the best service and solution. Let us make a better world for our industry!



Contact us

Tel: +86-755-8981 8866 Fax: +86-755-8427 6832

Email & Skype: info@chipsmall.com Web: www.chipsmall.com

Address: A1208, Overseas Decoration Building, #122 Zhenhua RD., Futian, Shenzhen, China



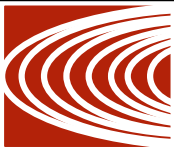

PERFORMANCE SPECIFICATION	MIN	TYP	MAX	UNITS
Lower Frequency:			1970	MHz
Upper Frequency:	2350			MHz
Tuning Voltage:	1.0		14.0	VDC
Supply Voltage:	6.175	6.5	6.825	VDC
Output Power:	+3.0	+5.0	+7.0	dBm
Supply Current:		15	25	mA
Harmonic Suppression (2 nd Harmonic)		-15	-10	dBc
Pushing:		1.0	2.0	MHz/V
Pulling, all Phases:		2.0	5.0	MHz pk-pk
Tuning Sensitivity:		37		MHz/V
Phase Noise @ 10kHz offset:		-101		dBc/Hz
Phase Noise @ 100kHz offset:		-120		dBc/Hz
Load Impedance:		50		Ω
Input Capacitance:			50	pF
Operating Temperature Range:	-40		+85	$^{\circ}\text{C}$
Storage Temperature Range:	-45		+90	$^{\circ}\text{C}$

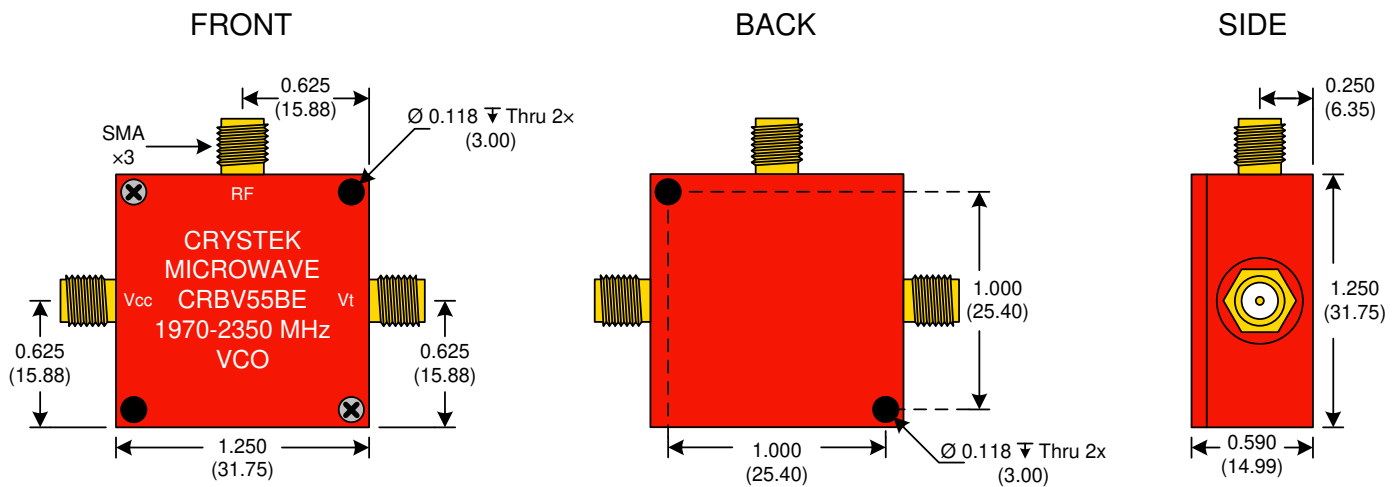

● Unless otherwise specified, Dimensions are in: $\frac{\text{IN}}{\text{mm}}$

Product Control:

Crystek Part Number:	CRBV55BE-1970-2350	Release Date:	24-Sep-08
Revision Level:	A	Responsible:	C. Vales