



Chipsmall Limited consists of a professional team with an average of over 10 year of expertise in the distribution of electronic components. Based in Hongkong, we have already established firm and mutual-benefit business relationships with customers from,Europe,America and south Asia,supplying obsolete and hard-to-find components to meet their specific needs.

With the principle of “Quality Parts,Customers Priority,Honest Operation,and Considerate Service”,our business mainly focus on the distribution of electronic components. Line cards we deal with include Microchip,ALPS,ROHM,Xilinx,Pulse,ON,Everlight and Freescale. Main products comprise IC,Modules,Potentiometer,IC Socket,Relay,Connector.Our parts cover such applications as commercial,industrial, and automotives areas.

We are looking forward to setting up business relationship with you and hope to provide you with the best service and solution. Let us make a better world for our industry!



Contact us

Tel: +86-755-8981 8866 Fax: +86-755-8427 6832

Email & Skype: info@chipsmall.com Web: www.chipsmall.com

Address: A1208, Overseas Decoration Building, #122 Zhenhua RD., Futian, Shenzhen, China



CRD Series 10mm DIP Coded Rotary Switches

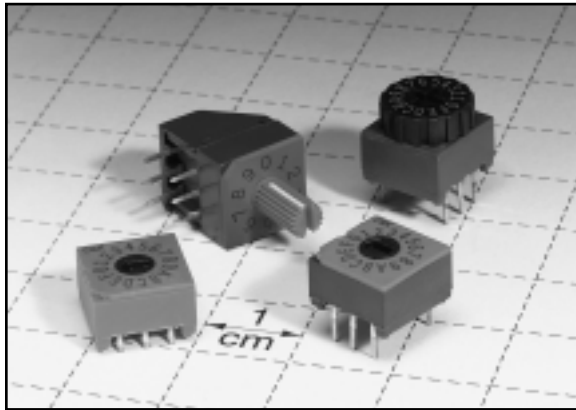

Features/Benefits

- **Process sealed** – withstands soldering and cleaning
- **Thru-hole and surface mount models**
- **Crisp, positive detent ensures actuation**

Typical Applications

- **Address switching applications**
- **Data storage devices**
- **Computer and peripherals**
- **Instrumentation**

How To Order

Our easy Build-A Switch concept allows you to mix and match options to create the switch you need. Below is a complete listing of options shown in catalog. To order, simply select desired option from each category and place in the appropriate box. Switches with standard options are shown on page D-17. Available options are shown and described on pages D-18 and D-19. For additional options not shown in catalog, consult Customer Service Center.

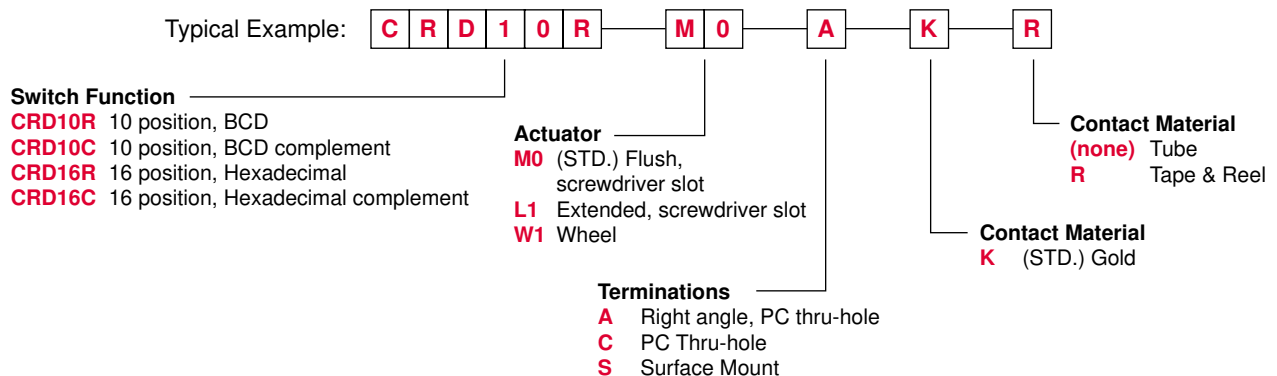

DIP

Specifications

CONTACT RATING: 0.4 V AC, DC 20 V max.
 ELECTRICAL LIFE: 20,000 steps min. @ 5 V DC 10 mA.
 MECHANICAL LIFE: 30,000 steps min.
 CONTACT RESISTANCE: 100 milliohms max. initial @ 2 V DC 10 mA.
 INSULATION RESISTANCE: 1000 megohms min. @ 100 V DC
 DIELECTRIC STRENGTH: 300 V AC for 1 minute.
 OPERATING TEMPERATURE: -20°C to 85°C.
 STORAGE TEMPERATURE: -40°C to 85°C.
 OPERATING FORCE: 1000 grams max.
 PACKAGING: Anti-static tube or tape & reel, 500 pieces per reel.

Materials

COVER: (PTH) PBT red; (SMT) PPA - red (UL 94V-0).
 HOUSING: (PTH) PBT green; (SMT) PPA - red (UL 94V-0).
 ACTUATOR: 4/6 nylon PA-6T (UL 94V-0).
 CONTACTS: Beryllium copper with gold over nickel.
 TERMINALS: Brass with tin-lead plated.

NOTE: Specifications and materials listed above are for switches with standard options. For information on specific and custom switches, consult Customer Service Center.

SWITCHES WITH STANDARD OPTIONS

PC Mount

PART NUMBER	NO. POS.	QUANTITY PER TUBE
CRD10RM0CK	10	45
CRD16RM0CK	16	45

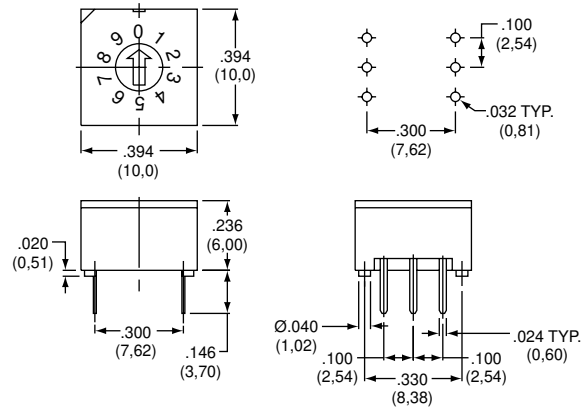

CRD10RM0CK

Right Angle Mount

PART NUMBER	NO. POS.	QUANTITY PER TUBE
CRD10RM0AK	10	45
CRD16RM0AK	16	45

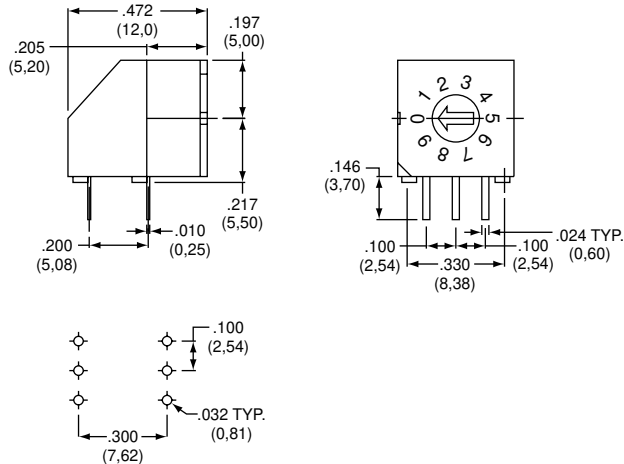

CD10RM0AK

Surface Mount

PART NUMBER	NO. POS.	QUANTITY PER TUBE
CRD10RM0SK	10	45
CRD16RM0SK	16	45

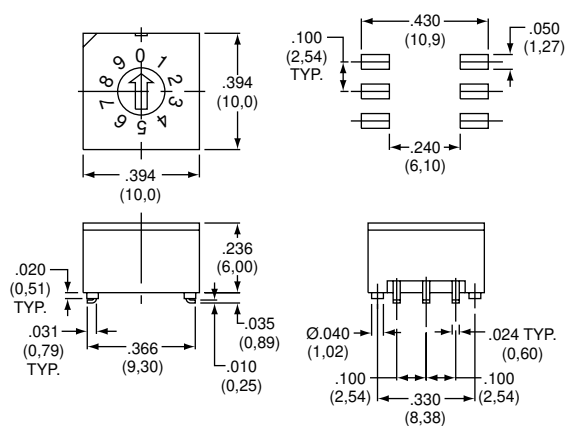

CD10RM0SK



DIP

CRD Series 10mm DIP Coded Rotary Switches



SWITCH FUNCTION

CRD10R 10 POSITION, BCD
ACTUATOR COLOR: WHITE

CRD10C 10 POSITION, BCD COMPLEMENT
ACTUATOR COLOR: BLACK

POS.	0	1	2	3	4	5	6	7	8	9
C	●	●	●	●	●	●	●	●	●	●
1		●		●		●		●		●
2			●	●			●	●		
4					●	●	●	●		
8									●	●

POS.	0	1	2	3	4	5	6	7	8	9
C	●	●	●	●	●	●	●	●	●	●
1	●		●		●		●		●	
2	●	●			●	●			●	●
4	●	●	●	●				●	●	●
8	●	●	●	●	●	●	●	●		

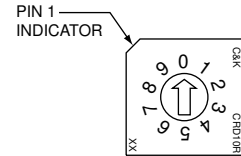

CRD16R 16 POSITION, HEXADECIMAL
ACTUATOR COLOR: WHITE

CRD16C 16 POSITION, HEXADECIMAL COMPLEMENT
ACTUATOR COLOR: BLACK

POS.	0	1	2	3	4	5	6	7	8	9	A	B	C	D	E	F
C	●	●	●	●	●	●	●	●	●	●	●	●	●	●	●	●
1		●		●		●		●		●		●		●		●
2			●	●			●	●			●	●			●	●
4					●	●	●	●				●	●	●	●	
8									●	●	●	●	●	●	●	●

POS.	0	1	2	3	4	5	6	7	8	9	A	B	C	D	E	F
C	●	●	●	●	●	●	●	●	●	●	●	●	●	●	●	●
1	●		●		●		●		●		●		●		●	
2	●	●			●	●			●	●			●	●		
4	●	●	●	●					●	●	●	●				
8	●	●	●	●	●	●	●	●								

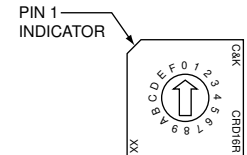

DIP

ACTUATOR

M0 (STD.) FLUSH WITH SCREWDRIVER SLOT

L1 EXTENDED WITH SCREWDRIVER SLOT

W1 WHEEL

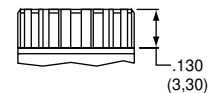
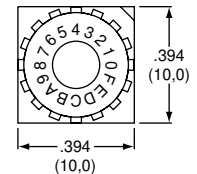
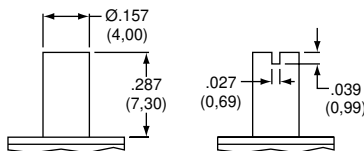
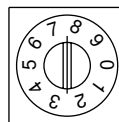
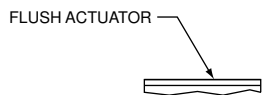
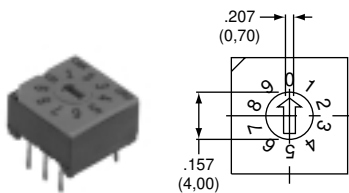

NOTE: Designed for #0 Phillips screwdriver.

TERMINATIONS

C PC THRU-HOLE

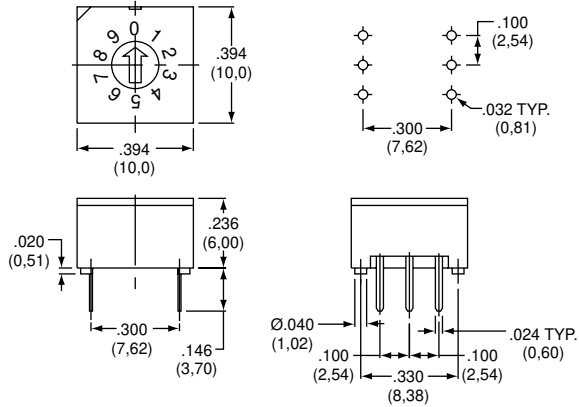

A RIGHT ANGLE, PC THRU-HOLE

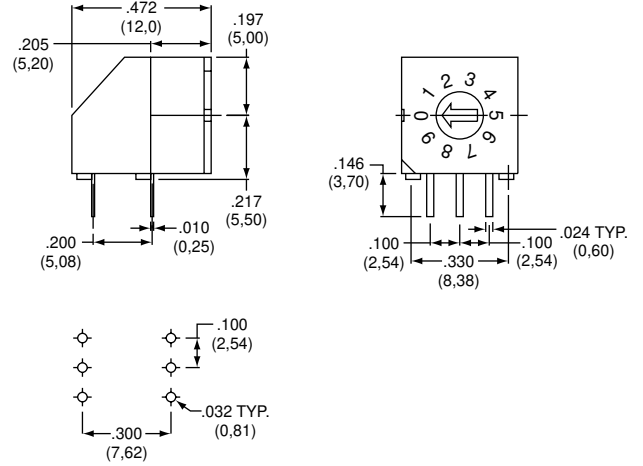

S SURFACE MOUNT

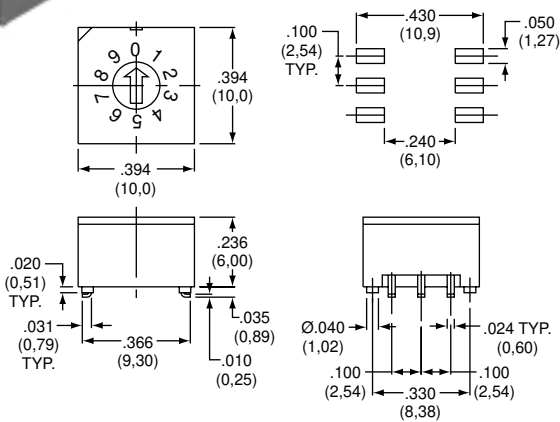

DIP

CONTACT MATERIAL

OPTION CODE	CONTACT MATERIAL	TERMINAL PLATING	RATING
K (STD.)	GOLD	TIN-LEAD	LOW LEVEL/DRY CIRCUIT 0.4 VC MAX. @ 20 V AC or DC MAX.