



Chipsmall Limited consists of a professional team with an average of over 10 year of expertise in the distribution of electronic components. Based in Hongkong, we have already established firm and mutual-benefit business relationships with customers from,Europe,America and south Asia,supplying obsolete and hard-to-find components to meet their specific needs.

With the principle of “Quality Parts,Customers Priority,Honest Operation,and Considerate Service”,our business mainly focus on the distribution of electronic components. Line cards we deal with include Microchip,ALPS,ROHM,Xilinx,Pulse,ON,Everlight and Freescale. Main products comprise IC,Modules,Potentiometer,IC Socket,Relay,Connector.Our parts cover such applications as commercial,industrial, and automotives areas.

We are looking forward to setting up business relationship with you and hope to provide you with the best service and solution. Let us make a better world for our industry!



Contact us

Tel: +86-755-8981 8866 Fax: +86-755-8427 6832

Email & Skype: info@chipsmall.com Web: www.chipsmall.com

Address: A1208, Overseas Decoration Building, #122 Zhenhua RD., Futian, Shenzhen, China



Electromagnetic Counter CSK

CSM_CSK_DS_E_2_1

Miniature, Electromagnetic Totalizing Counter

- High-speed response (up to 35 cps)
- Locking mechanism for errorless operation
- Unique mechanism eliminates digit displacement during resets
- UL listed model also available (File No. E67871)



Ordering Information

Numbering of digits	Mounting method		Surface mounting		Flush mounting	
			Wire-wrap terminals	Lead wires	Wire-wrap terminals	Lead wires
	Resetting system	Locking mechanism				
4 digits	Manual reset	No	CSK4	CSK4-W	CSK4-Y	CSK4-YW
		Yes	CSK4-K	CSK4-KW	CSK4-YK	CSK4-YKW
	Non-resetting	No	---	CSK4-LW	CSK4-YL	CSK4-YLW
6 digits	Manual reset	No	CSK6	CSK6-W	CSK6-Y	CSK6-YW
		Yes	CSK6-K	CSK6-KW	CSK6-YK	CSK6-YKW
	Non-resetting	No	---	CSK6-LW	CSK6-YL	CSK6-YLW

Note: 1. When placing your order, specify the desired supply voltage listed in *Specifications* and a UL listed model if required, in addition to the model number.

2. If a UL listed model is required, specify this in your order in addition to the desired model number.

Specifications

■ Ratings

Supply voltage (see note)	100, 200 VAC, 50/60 Hz 6, 12, 24, 48, 100 VDC
Operating voltage range	85% to 110% of rated voltage
Power consumption	AC: approx. 3 VA DC: approx. 3.5 W
ON time rating	Continuous rating
Counting speed	AC input: 15 cps (contact) (ON/OFF ratio: 1:1) DC input: 20 cps (contact) (ON/OFF ratio: 1:1)
Character height	4 mm

Note: The DC models have no polarity.

■ Characteristics

Insulation resistance	100 MΩ min. (at 500 VDC)
Dielectric strength	1,500 VAC, 50/60 Hz for 1 minute
Vibration resistance	Destruction: 16.7 Hz, 4 mm double amplitude Malfunction: 10 to 55 Hz, 0.5 mm double amplitude
Shock resistance	Destruction: 300 m/sec ² (approx. 30G) Malfunction: 50 m/sec ² (approx. 5G)
Ambient temperature	Operating: -10°C to 45°C Storage: -25°C to 65°C
Ambient humidity	45% to 85%
Life expectancy	50,000,000 counts
Approved standards (see note)	UL508
Weight	4-digit model: approx. 100 g 6-digit model: approx. 110 g

Note: These standards apply to the -US models only.

Dimensions

CSK4-W/KW/LW

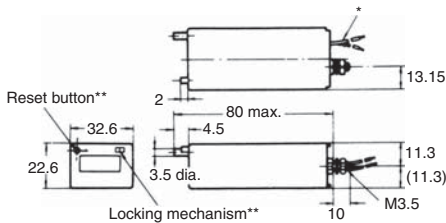

* Lead wire length: approx. 250

** CSK4-L and CSK4-LW are not provided with reset button nor locking mechanism.
CSK4 and CSK4-W are not provided with locking mechanism.

CSK4/K

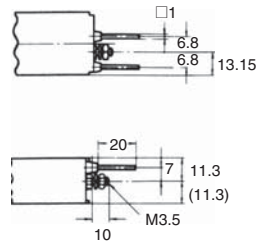

Mounting Holes CSK4-W/KW/LW

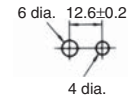

CSK4/K

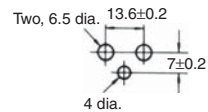

CSK6-W/KW/LW

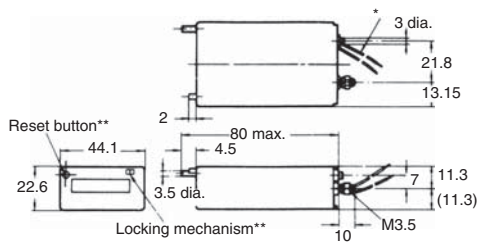

* Lead wire length: approx. 250

** CSK6-L and CSK6-LW are not provided with reset button nor locking mechanism.
CSK6 and CSK6-W are not provided with locking mechanism.

CSK6/K

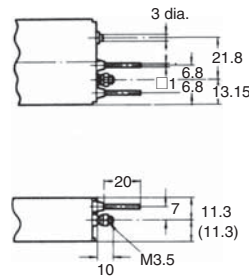

CSK6-W/KW/LW

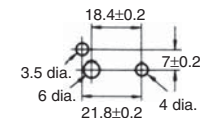

CSK6/K

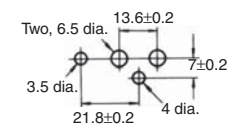

CSK4-YW/YKW/YLW

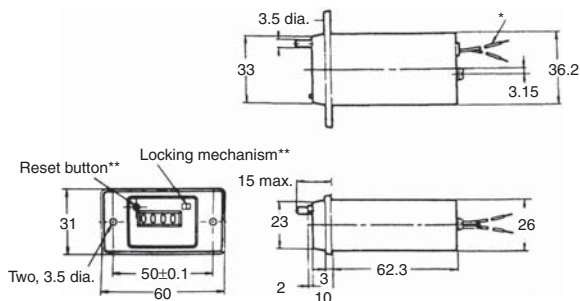

* Lead wire length: approx. 250

** CSK4-YL and CSK4-YLW are not provided with reset button nor locking mechanism.
CSK4-Y and CSK4-YW are not provided with locking mechanism.

CSK4-Y/YK/YL

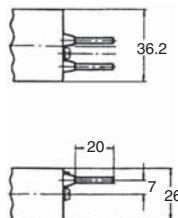

CSK4-YW/YKW/YLW CSK4-Y/YK/YL

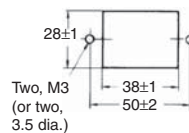

CSK6-YW/YKW/YLW

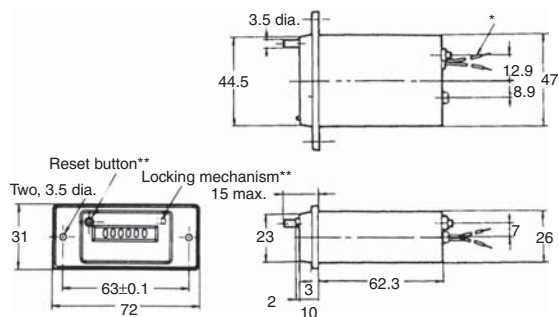

* Lead wire length: approx. 250

** CSK6-YL and CSK6-YLW are not provided with reset button nor locking mechanism.
CSK6-Y and CSK6-YW are not provided with locking mechanism.

CSK6-Y/YK/YL

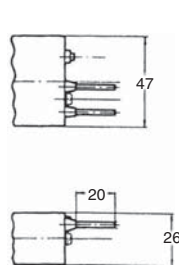

CSK6-YW/YKW/YLW
CSK6-Y/YK/YL

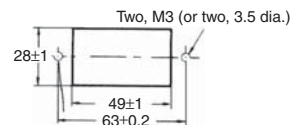

ALL DIMENSIONS SHOWN ARE IN MILLIMETERS.

To convert millimeters into inches, multiply by 0.03937. To convert grams into ounces, multiply by 0.03527.

In the interest of product improvement, specifications are subject to change without notice.