



Chipsmall Limited consists of a professional team with an average of over 10 year of expertise in the distribution of electronic components. Based in Hongkong, we have already established firm and mutual-benefit business relationships with customers from,Europe,America and south Asia,supplying obsolete and hard-to-find components to meet their specific needs.

With the principle of "Quality Parts,Customers Priority,Honest Operation,and Considerate Service",our business mainly focus on the distribution of electronic components. Line cards we deal with include Microchip,ALPS,ROHM,Xilinx,Pulse,ON,Everlight and Freescale. Main products comprise IC,Modules,Potentiometer,IC Socket,Relay,Connector.Our parts cover such applications as commercial,industrial, and automotives areas.

We are looking forward to setting up business relationship with you and hope to provide you with the best service and solution. Let us make a better world for our industry!



## Contact us

Tel: +86-755-8981 8866 Fax: +86-755-8427 6832

Email & Skype: info@chipsmall.com Web: www.chipsmall.com

Address: A1208, Overseas Decoration Building, #122 Zhenhua RD., Futian, Shenzhen, China



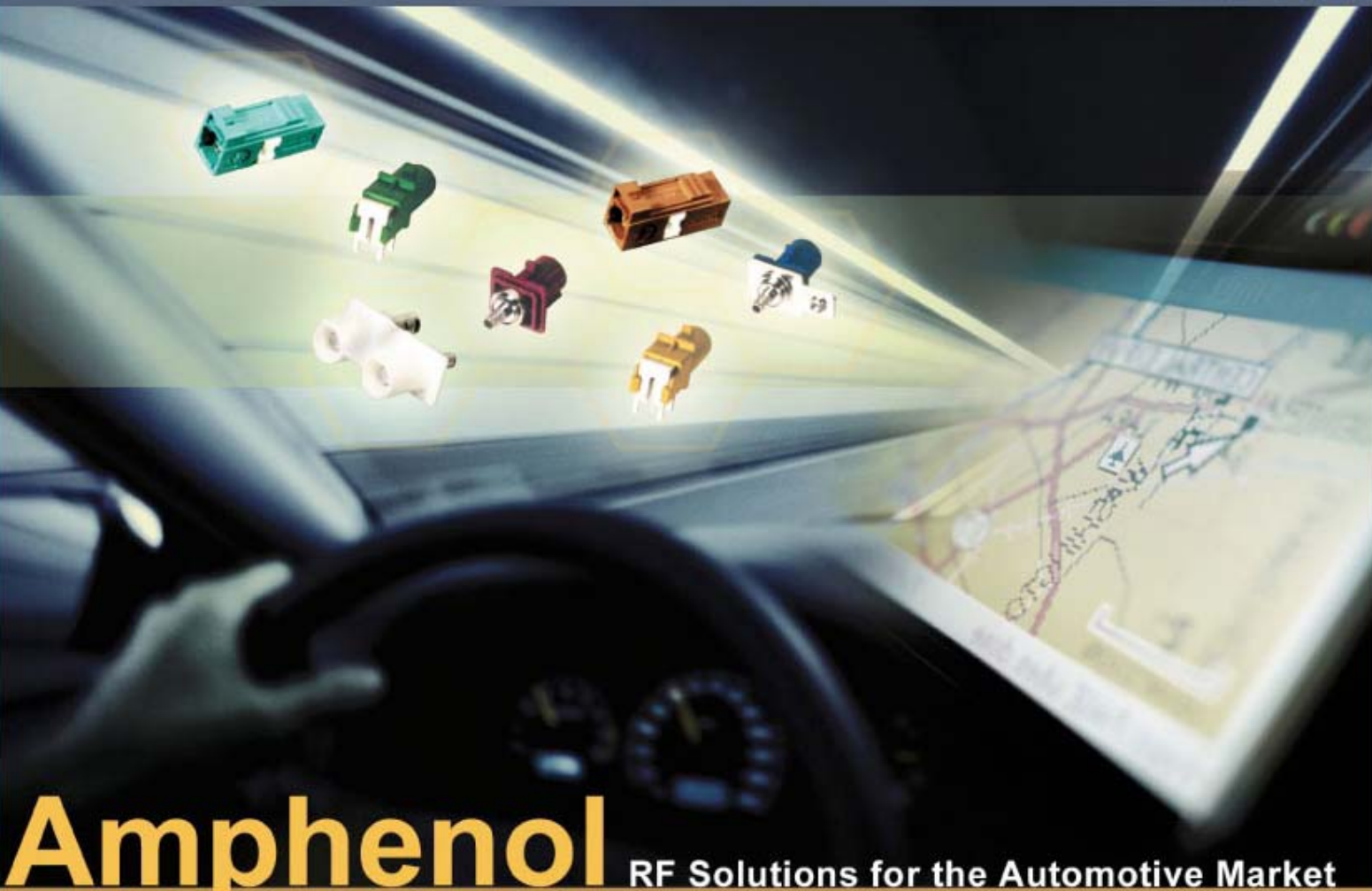

# Amphenol

RF Solutions for the Automotive Market



**FAKRA SMB Connectors  
Coaxial Cable**



# Contents

Introduction .....	2
Mechanical and Color Coding Overview .....	3-4
Part Numbering System Overview .....	4
FAKRA SMB Product Specifications .....	5
Interface Specifications .....	6-7
Recommended Tooling .....	7
Single Male FAKRA Connectors .....	8-9
FAKRA PCB/Edgecard Male Connectors .....	9-10
Dual Male FAKRA Connectors .....	11-12
Single R/A Female FAKRA Connectors .....	12-13
Single Female FAKRA Connectors .....	13-14
Dual Female FAKRA Connectors .....	15
Automotive Coaxial Cables .....	16
Assembly Instructions .....	17-20
Index of Part Numbers .....	21-22



# RF Solutions

## for the Automotive Market

With recent advancements in communications technology and increased consumer demand for a diverse array of on-board telematics services, RF communications systems have become indispensable components of the modern automobile.

To keep RF interconnection costs low and ensure high levels of electrical and mechanical performance for telematics applications such as Global Positioning Satellite, Satellite Radio, Vehicular Internet Access, Remote vehicle diagnostics and Bluetooth, the German and American automotive industries have standardized a high-performing, cost-effective RF connector based on the FAKRA and USCAR standards.

Utilizing a standard metal SMB connector embedded within a plastic housing that can be designed with multiple colored codes for easy identification, FAKRA connectors are designed to perform up to 4 GHz and meet the particular mechanical and environmental requirements of the automobile industry.

Amphenol RF's industry leading product line meets both the FAKRA and USCAR standards with the following features:

- 12 different mechanical and color codes
- Plastic housing with locking feature and audible clicking noise
- Minimum of 100 mating cycles
- Frequency range of DC - 4 GHz
- Usable on multiple coaxial cables (RG-58, RG-174, RG-316, RG-178 and other micro-cables)
- Available in numerous connector configurations (straight and right angle solutions for cable applications, as well as edge-launch and PCB designs)

Along with the growth of RF connection devices in the car, the need for coaxial cable has grown to a level which could require twice the amount of cable which goes into a home (over 100+ feet per car). To meet this demand, Amphenol's Times Fiber Communications division has developed a portfolio of cable products to meet the needs of the automotive industry. TFC's automotive cables are manufactured utilizing the highest quality materials and workmanship available:

- Lowest Signal Loss
- Multiple Shielding Options Available
- 100 % Quality Testing - Electricals, Physicals
- Superior TFC/Amphenol Product Development

## Mechanical and Color Coding

Coding	Rib Combination	Color	Similar RAL No.
A	A - B1	Deep Black ●	9005
B	A - B2	Signal White ●	9003
C	A - C	Signal Blue ●	5005
D	A - D	Bordeaux Violet ●	4004
E	B1 - B2	Leaf Green ●	6002
F	B1 - C	Brown ●	8011
G	B1 - D	Blue Grey ●	7031
H	B2 - C	Heather Violet ●	4003
I	B2 - D	Beige ●	1001
K	C - D	Curry Yellow ●	1027
W	Neutral Coding	Signal White ●	9003
Z	Neutral Coding	Water Blue ●	5021

## Female FAKRA Housings

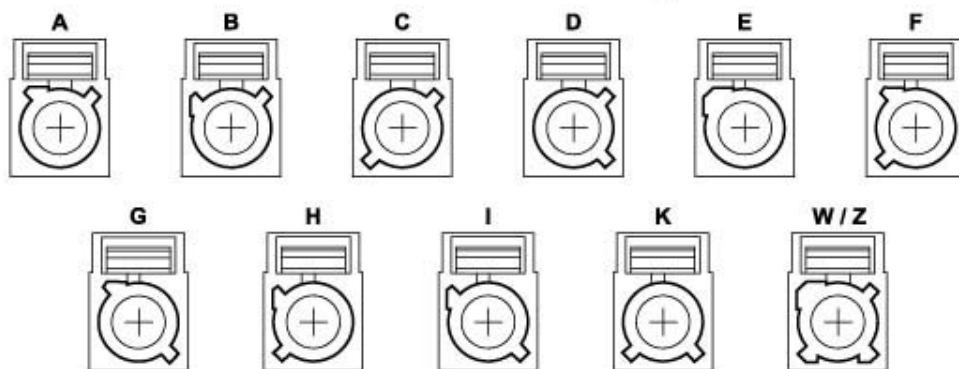

## Male FAKRA Housings

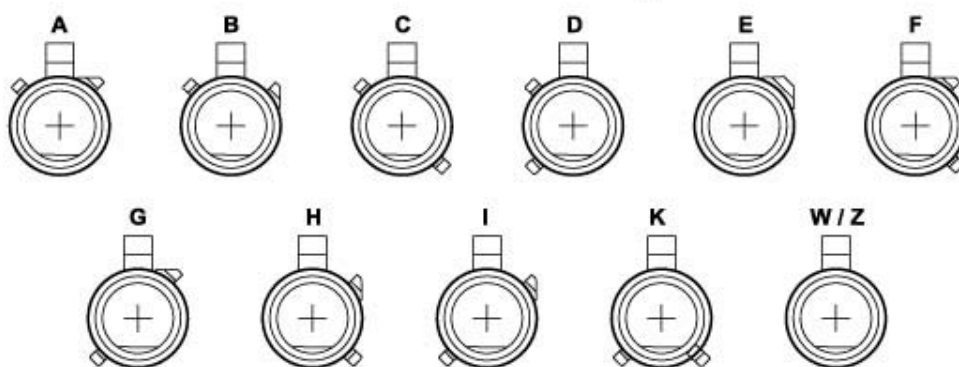

## Amphenol RF FAKRA Part Numbering System Overview

### Single Series - FA1

F	A	1	-	N	X	S	P	-	C	*	*	-	#
Series		Tab Location North South East West		Keying Codes	Style Straight Right Angle	Gender P(Male) J(Female)	Attachment			Special			
							C	*	*				
							P	C	B				

### Dual Series - FA2

F	A	2	-	N	X	S	P	-	C	*	*	-	#
Series		Tab Location North South East West		Keying Codes	Style Straight Right Angle	Gender P(Male) J(Female)	Attachment			Special			
							C	*	*				
							P	C	B				

**	Cable Group Codes
00	RG-58/RG-174 Combo Design
01	RG 174, 188, 316
04	RG 58, 141
09	Cables with .057 OD
10	RG-178, .071 OD Cables
13	RG-174 LL Cable

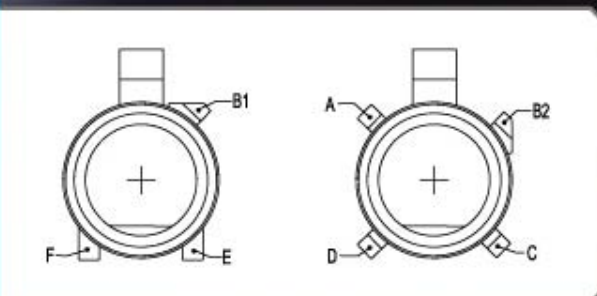
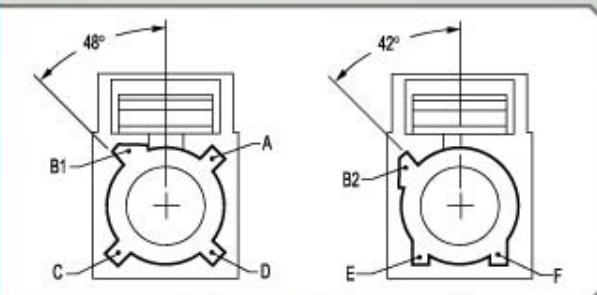

#	Special Codes ( Female )
0	Standard
3	360° Design (R/A only)
6	Clip provision at 180°

#	Special Codes ( Male )
0	Standard Bracket
1	Standard ( Single )
9	Standard ( Dual )
X	Special Bracket

#	Special Codes ( Male PCB )
0	Edge Card
1	Edge Card W/ Support Legs
2	Vertical Mount
6	R/A Extended Nose (Gold)
8	R/A Extended Nose (Tin)
9	R/A Extended Nose (Nickel)
M	Die Cast R/A
S	Stamped & Formed R/A



## FAKRA SMB Product Specifications

### ELECTRICAL

Impedance		50 $\Omega$
Frequency Range		DC - 4 GHz
Performance Spec		SAE/USCAR-17, 18
V.S.W.R.		DC - 2 GHz      2 GHz - 4 GHz
	<i>spec requirement</i>	1.40 max.      1.50 max.
	<i>straight SMB male and female(cable group 1)</i>	1.15 max.      1.25 max.
	<i>RIA SMB male and straight female(cable group 1)</i>	1.20 max.      1.35 max.
	<i>straight SMB male and female(cable group 4)</i>	1.10 max.      1.15 max.
Insertion Loss	<i>spec requirement</i>	< .3 dB max from DC - 3 GHz
	<i>up to 1 GHz</i>	< .1 dB
	<i>up to 2 GHz</i>	< .2 dB
	<i>up to 4 GHz</i>	< .3 dB
Insulation Resistance		1000 M $\Omega$ min
Center Contact Resistance	<i>center contact</i>	< 20 m $\Omega$
	<i>outer contact</i>	< 10 m $\Omega$
Dielectric Withstanding Voltage	<i>at sea level</i>	> 1000 VRMS

### MECHANICAL

Durability (matings)		100 min
Plastic Housing - Engagement Force		$\leq$ 20 N
Plastic Housing - Disengagement Force		$\geq$ 25 N
Cable Retention Force	<i>cable group 1</i>	$\geq$ 110 N
	<i>cable group 4</i>	$\geq$ 180 N
Coding		12 mechanical and colored codings

### ENVIRONMENTAL

Temperature Range	<i>operating</i>	-40 / +115° C
Thermal Shock		MIL-STD-202, Method 107, Cond. B (-55 / +125° C)
Vibration		MIL-STD-202, Method 204, Cond. B (15g)
Shock		MIL-STD-202, Method 213, Cond. B (75g, 6 ms, 1/2 sine)

### MATERIALS

Plastic Housing	<i>jacks</i>	Nylon 6 / 6
	<i>in-line plugs</i>	PBT+15%GF
	<i>PCB plugs</i>	Nylon 6 / 6
Secondary Locking Clip		PBT w/ 15% Glass Fiber
Center Contact	<i>female</i>	Beryllium Copper
	<i>male</i>	Brass
Body		Brass
Barrel		Brass
Retainer Ring		Beryllium Copper
Ferrule		Copper
Insulator		TFE

### PLATING

Center Contact		Gold
Body	<i>cable types</i>	Nickel
	<i>solder types</i>	Nickel, Gold, Tin
Barrel		Nickel
Ferrule		Nickel

## Female(J) FAKRA Interface Specifications

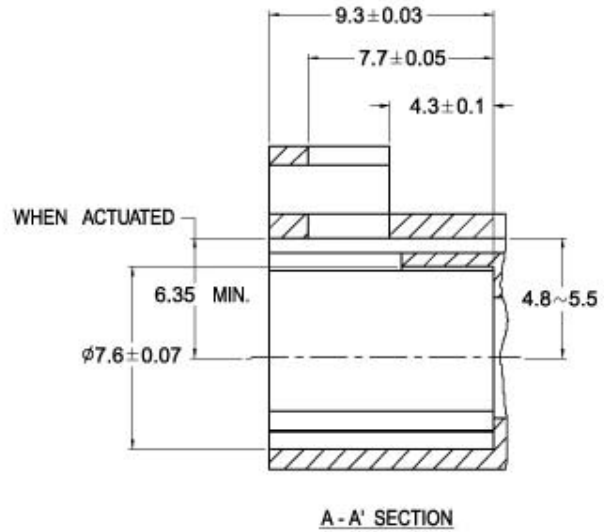
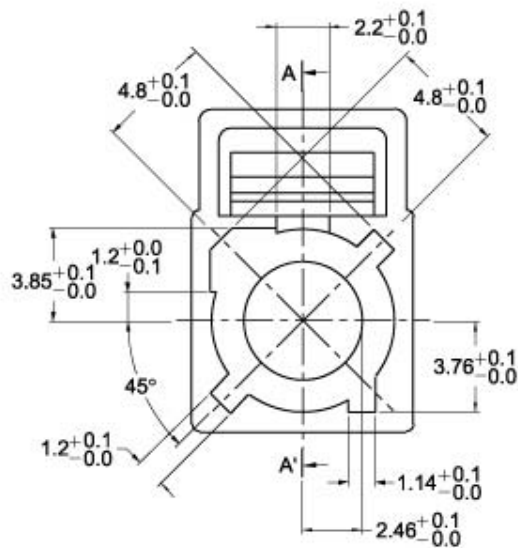

## Male(P) FAKRA Interface Specifications

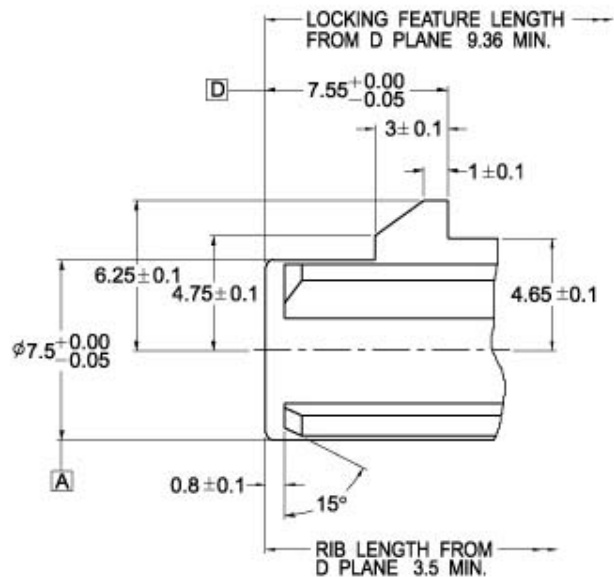
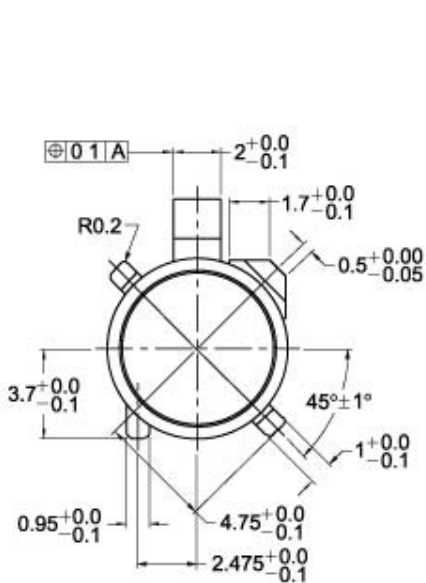



## Male(P) FAKRA Detailed Interface Specifications

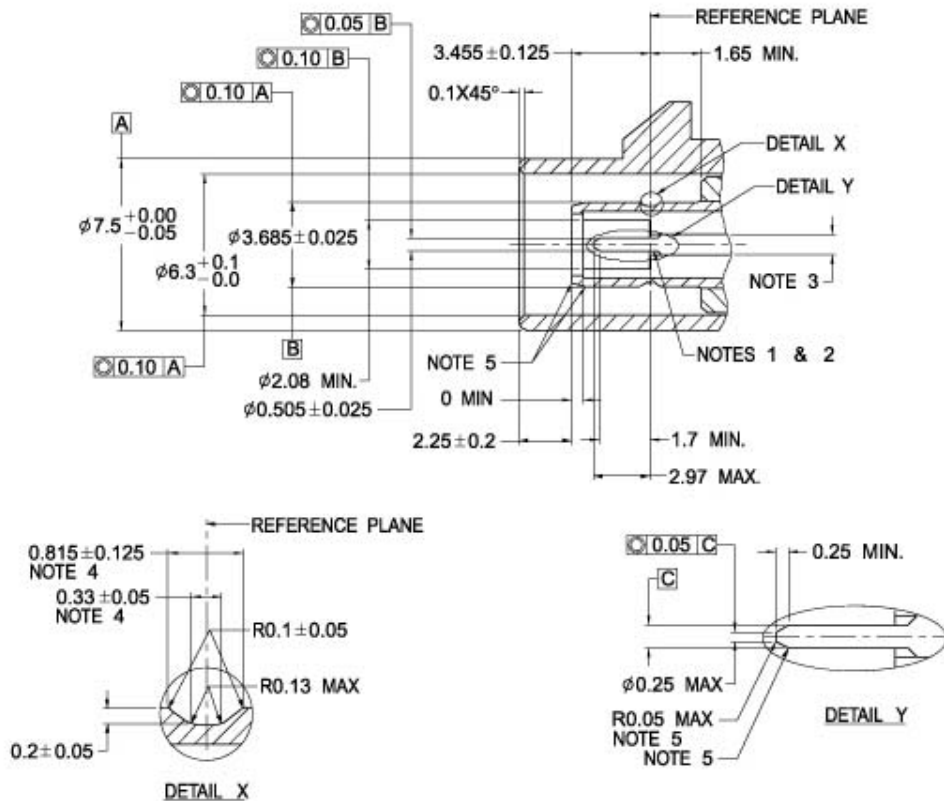

### NOTES:

1. CONTACT TO BE 0.18 MAX BELOW INSULATOR SHOULDER
2. INSULATOR SHOULDER TO BE 0.18 MAX IN FRONT OF REF. PLANE
3. THE  $\phi$  OF THE CENTER CONDUCTOR PIN, AND OF THE UNIFORM TRANSMISSION LINE TO GIVE REQUIRED CHARACTERISTIC IMPEDANCE OF 50 OHM
4. GROOVE SYMMETRICAL TO REFERENCE PLANE
5. NO SHARP EDGES ALLOWED









### Recommended Tooling (Daniels Manufacturing)

	RG-174, RG-316 Cables			RG-58		
	Center Pin	Ferrule(Single)	Ferrule(Dual)	Center Pin	Ferrule(Single)	Ferrule(Dual)
Hand Crimp Tool	AFM8	HX4	HX4	AFM8	HX4	HX4
Pneumatic Crimp Tool	WA22	HX23	HX23	WA22	HX23	HX23
Die Set (Positioner)	K727	Y119 or Y1831	Y1831	K1470	Y188 or Y1832	Y1832
Depth Setting	4 or 5*	-	-	6 or 7*	-	-

Please note: The dual ferrule die sets can be used on the single ferrule designs.

- \* Depth setting should be used at minimum setting which will yield wire minimum 5 lbs pull-off force.
- \* Depth setting requirements depend upon several factors including wire manufacturer + grade.

	<p><b>Single Male FAKRA for Cable Group 1</b></p> <p><b>Global Part Number: FA1-NXSP-C01-1</b>  ARFA Part Number: FK1121XX-007-NT30G-50  Cable Sizes: RG-174, 316 type  Assembly Instructions: FAKRA C1</p>
	<p><b>Single Male FAKRA for Cable Group 4</b></p> <p><b>Global Part Number: FA1-NXSP-C04-1</b>  ARFA Part Number: FK1121XX-008-NT30G-50  Cable Sizes: RG-58 type  Assembly Instructions: FAKRA C1</p>
	<p><b>Single Male FAKRA for Cable Group 1, Second Generation</b></p> <p><b>Global Part Number: 2FA1-NXSP-C01-1</b>  ARFA Part Number:  Cable Sizes: RG-174, 316 type  Assembly Instructions: FAKRA C1</p>
	<p><b>Single Male FAKRA for Cable Group 4, Second Generation</b></p> <p><b>Global Part Number: 2FA1-NXSP-C04-1</b>  ARFA Part Number:  Cable Sizes: RG-58 type  Assembly Instructions: FAKRA C1</p>
	<p><b>Single Male FAKRA with Bracket for Cable Group 1</b></p> <p><b>Global Part Number: FA1-NXSP-C01-0</b>  ARFA Part Number: FK1321XX-007-NT30G-50  Cable Sizes: RG-174, 316 type  Assembly Instructions: FAKRA C1</p>
	<p><b>Single Male FAKRA with Bracket for Cable Group 4</b></p> <p><b>Global Part Number: FA1-NXSP-C04-0</b>  ARFA Part Number: FK1321XX-008-NT30G-50  Cable Sizes: RG-58 type  Assembly Instructions: FAKRA C1</p>



### Single Male Panel Front Mount FAKRA for Cable Group 1

**Global Part Number: FA1-NXSP-C01-5**  
ARFA Part Number: FK1321XX-023-NT30G-50  
Cable Sizes: RG-174, 316 type  
Assembly Instructions: FAKRA C4



### Single Male Panel Front Mount FAKRA for Cable Group 1

**Global Part Number: FA1-NXSP-C01-6**  
ARFA Part Number: FK1321XX-026-NT30G-50  
Cable Sizes: RG-174, 316 type  
Assembly Instructions: FAKRA C4  
**Remark: With gasket**



### FAKRA Edgecard Male with two lockpins

**Global Part Number: FA1-NXSP-PCB-0**  
ARFA Part Number: FK1251XX-3GT30G-50  
Cable Sizes: N/A  
Assembly Instructions: N/A



### FAKRA Edgecard Male

**Global Part Number: FA1-NXSP-PCB-1**  
ARFA Part Number: FK1251XX-001-3GT30G-50  
Cable Sizes: N/A  
Assembly Instructions: N/A



### FAKRA PCB Mount Male

**Global Part Number: FA1-NXSP-PCB-2**  
ARFA Part Number: FK1251XX-002-3GT30G-50  
Cable Sizes: N/A  
Assembly Instructions: N/A



### FAKRA R/A PCB Mount Male with Bracket

**Global Part Number: FC2-NKERP-PCB-S**  
ARFA Part Number: FK1252 KEW-NT30G-50  
Cable Sizes: N/A  
Assembly Instructions: N/A  
**Remark: Two in One**



### FAKRA R/A PCB Mount Male, Extended Nose

**Global Part Number: FA1-NXRP-PCB-X**

ARFA Part Number:

Cable Sizes: N/A

Assembly Instructions: N/A

**Remark: Global part number with - 6 (gold), - 8 (tin), - 9 (nickel), - A(completely assembled)**



### FAKRA R/A PCB Mount Male

**Global Part Number: PSE-LP-PC-8-XX**

ARFA Part Number: 10058-XX

Cable Sizes: N/A

Assembly Instructions: N/A



### FAKRA R/A PCB Mount Male

**Global Part Number: FA1-NXRP-PCB-10**

ARFA Part Number: FK1252XX-005-NT30G-50

Cable Sizes: N/A

Assembly Instructions: N/A



### FAKRA R/A SMT PCB Mount Male

**Global Part Number: FA1-NXRP-PCB-11**

ARFA Part Number: FK1252XX-010-NT30G-50

Cable Sizes: N/A

Assembly Instructions: N/A



### FAKRA R/A PCB Mount Male

**Global Part Number: FA1-NXRP-PCB-M**

ARFA Part Number:

Cable Sizes: N/A

Assembly Instructions: N/A

**Remark: Tape & Reel Packaging**



### FAKRA Straight SMT PCB Male, Die Cast body

**Global Part Number: FA1-NXSP-PCB-X**

ARFA Part Number:

Cable Sizes: N/A

Assembly Instructions: N/A

**Remark: Tape & Reel Packaging**



#### Dual Male FAKRA for Cable Group 4

**Global Part Number: FA2-NXSP-C04-9**

ARFA Part Number: FKT1121XX-008-NT30G-50

Cable Sizes: RG-58 type

Assembly Instructions: FAKRA C1



#### Dual Male FAKRA for Cable Group 1

**Global Part Number: FA2-NXSP-C01-9**

ARFA Part Number: FKT1121XX-007-NT30G-50

Cable Sizes: RG-174, 316 type

Assembly Instructions: FAKRA C1



#### Dual Male FAKRA for Cable Group 0

**Global Part Number: FA2-NXSP-C00-9**

ARFA Part Number: FKT1121XX-009-NT30G-50

Cable Sizes: RG-58/RG-174 Combo type

Assembly Instructions: FAKRA C1



#### Dual Male FAKRA for Cable Group 4, Second Generation

**Global Part Number: 2FA2-NXSP-C04-9**

ARFA Part Number:

Cable Sizes: RG-58 type

Assembly Instructions: FAKRA C1



#### Dual Male FAKRA for Cable Group 1, Second Generation

**Global Part Number: 2FA2-NXSP-C01-9**

ARFA Part Number:

Cable Sizes: RG-174, 316 type

Assembly Instructions: FAKRA C1



#### Dual Male FAKRA for Cable Group 0, Second Generation

**Global Part Number: 2FA2-NXSP-C00-9**

ARFA Part Number:

Cable Sizes: RG-58/RG-174 Combo type

Assembly Instructions: FAKRA C1



#### Dual Male FAKRA with Bracket for Cable Group 1

**Global Part Number: FC2-NEKSP-C01-X**

ARFA Part Number: FKT1121EKW-007-NT30G-50

Cable Sizes: RG-174, 316 type

Assembly Instructions: FAKRA C1

**Remark: Two in One**



#### Dual Male FAKRA with Bracket for Cable Group 10

**Global Part Number: FA2-NXSP-C10-0**

ARFA Part Number: FKT1321XX-002-NT30G-50

Cable Sizes: RG-178, 196 type

Assembly Instructions: FAKRA C1



#### Dual Male FAKRA with Bracket for Cable Group 4

**Global Part Number: FA2-NXSP-C04-0**

ARFA Part Number: FKT1321XX-008-NT30G-50

Cable Sizes: RG-58 type

Assembly Instructions: FAKRA C1



#### Dual Male FAKRA with Bracket for Cable Group 0

**Global Part Number: FA2-NXSP-C00-0**

ARFA Part Number: FKT1321XX-009-NT30G-50

Cable Sizes: RG-58/RG-174 Combo type

Assembly Instructions: FAKRA C1



#### Dual Male FAKRA with Bracket for Cable Group 0

**Global Part Number: FC2-NCDS-PC00-0**

ARFA Part Number: FKT1321CDW-009-NT30G-50

Cable Sizes: RG-58/RG-174 Combo type

Assembly Instructions: FAKRA C1

**Remark: Two in One**



#### Single R/A Female FAKRA for Cable Group 1

**Global Part Number: FA1-NXRJ-C01-0**

ARFA Part Number: FK6112XX-007-NT30G-50

Cable Sizes: RG-174, 316 type

Assembly Instructions: FAKRA C3



#### Single R/A Female FAKRA for Cable Group 4

**Global Part Number: FA1-NXRJ-C04-0**  
ARFA Part Number: FK6112XX-008-NT30G-50  
Cable Sizes: RG-58 type  
Assembly Instructions: FAKRA C3



#### Single R/A Female FAKRA for Cable Group 1

**Global Part Number: 2FA1-NXRJ-C01-0**  
ARFA Part Number: FK6112XX-027-NT30G-50  
Cable Sizes: RG-174, 316 type  
Assembly Instructions: FAKRA C3



#### Single R/A Female FAKRA for Cable Group 4

**Global Part Number: 2FA1-NXRJ-C04-0**  
ARFA Part Number: FK6112XX-028-NT30G-50  
Cable Sizes: RG-58 type  
Assembly Instructions: FAKRA C3



#### 360° Rotating Single R/A Female FAKRA for Cable Group 1

**Global Part Number: FA1-NXRJ-C01-3**  
ARFA Part Number: FK6112XX-037-NT30G-50  
Cable Sizes: RG-174, 316 type  
Assembly Instructions: FAKRA C3



#### 360° Rotating Single R/A Female FAKRA for Cable Group 4

**Global Part Number: FA1-NXRJ-C04-3**  
ARFA Part Number: FK6112XX-038-NT30G-50  
Cable Sizes: RG-58 type  
Assembly Instructions: FAKRA C3



#### Single Female FAKRA for Cable Group 1, Second Generation

**Global Part Number: 2FA1-NXSJ-C01-0**  
ARFA Part Number: FK6121XX-012-NT30G-50  
Cable Sizes: RG-174, 316 type  
Assembly Instructions: FAKRA C1



#### Single Female FAKRA for Cable Group 4

**Global Part Number: FA1-NXSJ-C04-0**  
ARFA Part Number: FK6121XX-008-NT30G-50  
Cable Sizes: RG-58 type  
Assembly Instructions: FAKRA C2



#### Single Female FAKRA for Cable Group 1

**Global Part Number: FA1-NXSJ-C01-0**  
ARFA Part Number: FK6121XX-007-NT30G-50  
Cable Sizes: RG-174, 316 type  
Assembly Instructions: FAKRA C2



#### Single Female FAKRA for Cable Group 9

**Global Part Number: FA1-NXSJ-C09-0**  
ARFA Part Number: FK6121XX-003-NT30G-50  
Cable Sizes: .057 OD cable type  
Assembly Instructions: FAKRA C2



#### Single Female FAKRA for Cable Group 10

**Global Part Number: FA1-NXSJ-C10-0**  
ARFA Part Number: FK6121XX-002-NT30G-50  
Cable Sizes: RG-178, 196, .071 OD cable type  
Assembly Instructions: FAKRA C2



#### Single Female FAKRA with Clip Provision at 6 o'clock for Cable Group 4

**Global Part Number: FA1-NXSJ-C04-6**  
ARFA Part Number: FK6121XX-010-NT30G-50  
Cable Sizes: RG-58 type  
Assembly Instructions: FAKRA C2



#### Single Female FAKRA with Clip Provision at 6 o'clock for Cable Group 1

**Global Part Number: FA1-NXSJ-C01-6**  
ARFA Part Number: FK6121XX-005-NT30G-50  
Cable Sizes: RG-174, 316 type  
Assembly Instructions: FAKRA C2





#### Dual Female FAKRA for Cable Group 4

**Global Part Number: FA2-NXSJ-C04-0**  
ARFA Part Number: FKT6121XX-008-NT30G-50  
Cable Sizes: RG-58 type  
Assembly Instructions: FAKRA C2



#### Dual Female FAKRA for Cable Group 1

**Global Part Number: FA2-NXSJ-C01-0**  
ARFA Part Number: FKT6121XX-007-NT30G-50  
Cable Sizes: RG-174, 316 type  
Assembly Instructions: FAKRA C2



#### Dual Female FAKRA with Clip Provision at 6 o'clock for Cable Group 1

**Global Part Number: FA2-NXSJ-C01-6**  
ARFA Part Number: FKT6121XX-005-NT30G-50  
Cable Sizes: RG-174, 316 type  
Assembly Instructions: FAKRA C2









#### Dual Female FAKRA with Clip Provision at 6 o'clock for Cable Group 4

**Global Part Number: FA2-NXSJ-C04-6**  
ARFA Part Number: FKT6121XX-010-NT30G-50  
Cable Sizes: RG-58 type  
Assembly Instructions: FAKRA C2



#### Dual Female FAKRA with Clip Provision at 6 o'clock for Cable Group 0

**Global Part Number: FA2-NXSJ-C00-6**  
ARFA Part Number: FKT6121XX-011-NT30G-50  
Cable Sizes: RG-58/RG-174 Combo type  
Assembly Instructions: FAKRA C2

	<p><b>RG 58 Type, Stranded Solid Copper Center Conductor</b></p> <p>Material Identification Number: 021A1  Product Description: T58SCPN96T-VB</p>
	<p><b>RG 58 Type-Low Loss, Stranded Solid Copper Center Conductor</b></p> <p>Material Identification Number: 021A8  Product Description: T58SC85T-VB</p>
	<p><b>RG 58 Type, Stranded Solid Copper Clad Steel Center Conductor</b></p> <p>Material Identification Number: 021G4  Product Description: T58STTCPN96T-VB</p>
	<p><b>RG 174 Type, Stranded Solid Copper Center Conductor</b></p> <p>Material Identification Number: 025FO  Product Description: T174STCSPN85T-VB</p>
	<p><b>RG 174 Type-Low Loss, Solid Copper Center Conductor</b></p> <p>Material Identification Number: 025F7  Product Description: T174PD93T-VB</p>
	<p><b>RG 62 Type-Low Loss, Solid Copper Center Conductor</b></p> <p>Material Identification Number: 021G1  Product Description: T62N94C-VB</p>



## Straight Male(P) FAKRA Cable Assembly Instructions (FAKRA C1)

STEP 1. All parts of the connector are shown.

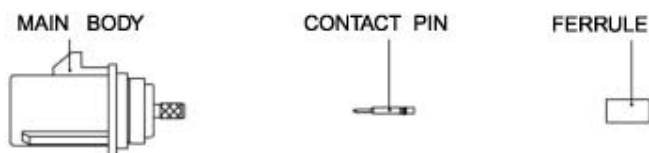

STEP 2. Strip the cable inner conductor, dielectric, braid and jacket as shown.



STEP 3. Insert the inner conductor into the CONTACT PIN. Crimp the center contact with the crimping tool. Slide the FERRULE onto the cable.



STEP 4. Insert the MAIN BODY into the braid and dielectric until it bottoms against the insulator.

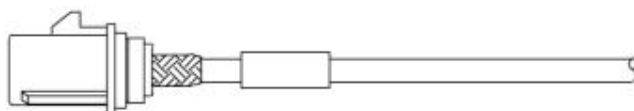

STEP 5. Slide the FERRULE over the braid and crimp. Verify pin height from end of SMB metal body to top of contact (.53-1.15mm).

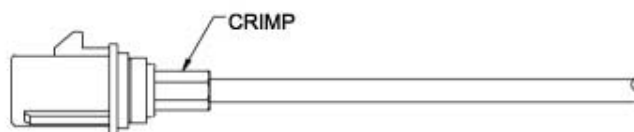

Cable Group	Stripping Length(mm)			Center Contact Crimp Tool	Ferrule Crimp Size
	A	B	C		
1	.118"(3 mm)	.110"(2.8 mm)	.205"(5.2 mm)	AFM8	Hex .128"(3.25 mm)
4	.118"(3 mm)	.067"(1.7 mm)	.327"(8.3 mm)	AFM8	Hex .213"(5.41 mm)
10	.118"(3 mm)	.102"(2.6 mm)	.205"(5.2 mm)	AFM8	Hex .128"(3.25 mm)

Please refer to FAKRA catalog for recommended tools.

## Straight Female(J) FAKRA Cable Assembly Instructions (FAKRA C2)

STEP 1. All parts of the connector are shown.

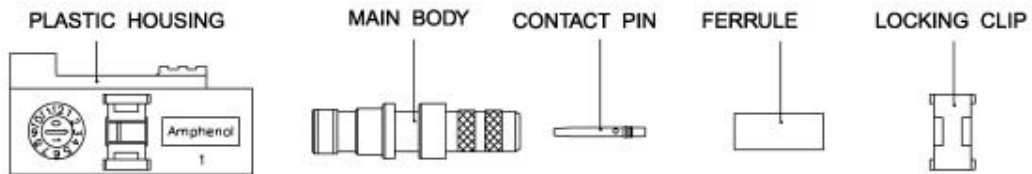

STEP 2. Strip the cable inner conductor, dielectric, braid and jacket as shown.



STEP 3. Insert the inner conductor into the CONTACT PIN. Crimp the center contact with the crimping tool. Slide the FERRULE onto the cable.



STEP 4. Insert the MAIN BODY into the braid and dielectric until it bottoms against the insulator. Slide the FERRULE over the braid and crimp.



STEP 5. Insert MAIN BODY into the PLASTIC HOUSING, and press the LOCKING CLIP into it. Verify pin height from end of SMB metal body to top of contact (1.18-1.81mm).

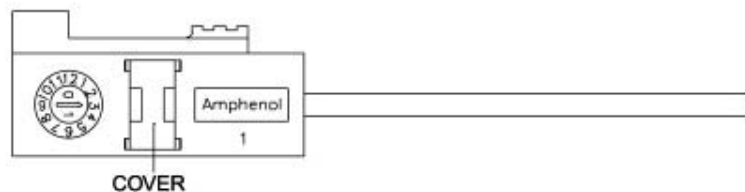

Cable Group	Stripping Length(mm)			Center Contact Crimp Tool	Ferrule Crimp Size
	A	B	C		
1	.118"(3 mm)	.110"(2.8 mm)	.205"(5.2 mm)	AFM8	Hex .128"(3.25 mm)
4	.118"(3 mm)	.067"(1.7 mm)	.327"(8.3 mm)	AFM8	Hex .213"(5.41 mm)
9	.095"(2.4 mm)	.228"(5.8 mm)	.224"(5.7 mm)	AFM8	Hex .128"(3.25 mm)
10	.118"(3 mm)	.102"(2.6 mm)	.205"(5.2 mm)	AFM8	Hex .128"(3.25 mm)

Please refer to FAKRA catalog for recommended tools.

## Right Angle Female(J) FAKRA Cable Assembly Instructions (FAKRA C3)

STEP 1. All parts of the connector are shown.

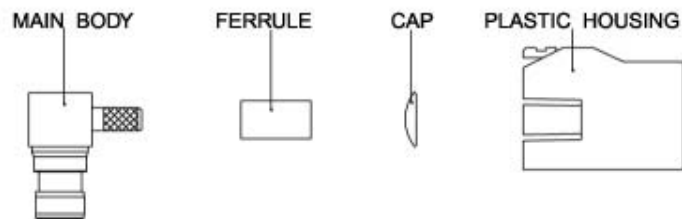

STEP 2. Strip the cable inner conductor, dielectric, braid and jacket as shown.



STEP 3. Slide the FERRULE onto the cable. Solder the inner conductor to the contact pin of the MAIN BODY. Insert the MAIN BODY into the braid and dielectric.

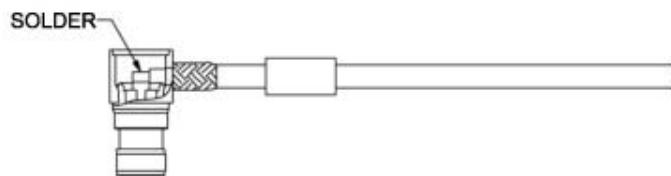

STEP 4. Slide the FERRULE over the braid and crimp. Press the cap into the MAIN BODY.

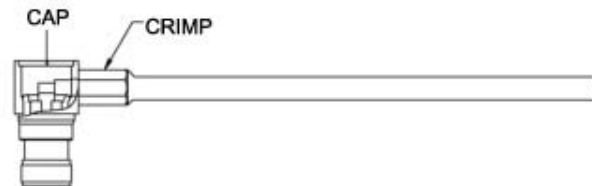

STEP 5. Insert the MAIN BODY into the PLASTIC HOUSING.

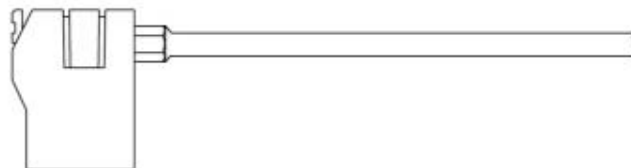

Cable Group	Stripping Length(mm)			Center Contact Termination	Ferrule Crimp Size
	A	B	C		
1	.106"(2.7 mm)	.028"(0.7 mm)	.217"(5.5 mm)	Solder	Hex .128"(3.25 mm)
4	.118"(3 mm)	.130"(3.3 mm)	.327"(8.3 mm)	Solder	Hex .213"(5.41 mm)
9	.106"(2.7 mm)	.028"(0.7 mm)	.217"(5.5 mm)	Solder	Hex .128"(3.25 mm)

Please refer to FAKRA catalog for recommended tools.

## Straight Male(P) FAKRA Cable Assembly Instructions (FAKRA C4)

STEP 1. All parts of the connector are shown.

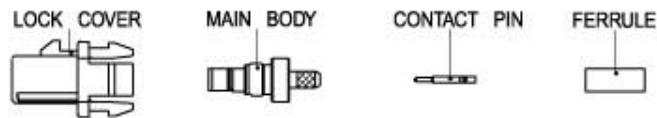

STEP 2. Strip the cable as shown.



STEP 3. Press the LOCK COVER into the PANEL.

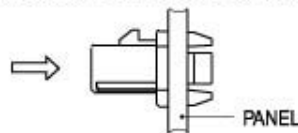

STEP 4. Insert inner conductor into the CONTACT PIN and crimp it.



STEP 5. Slide the FERRULE onto the cable, and insert the MAIN BODY into the braid and dielectric.

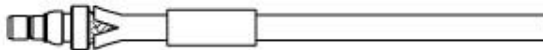

STEP 6. Slide the FERRULE over the braid and crimp it.

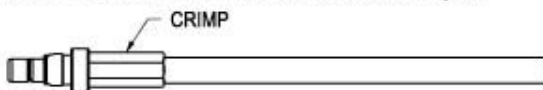

STEP 7. Insert the MAIN BODY into the LOCK COVER until a "Click" is obtained.

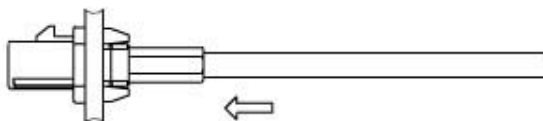

Cable Group	Stripping Length(mm)			Center Contact Crimp Tool	Ferrule Crimp Size
	A	B	C		
1	.118"(3 mm)	.110"(2.8 mm)	.205"(5.2 mm)	AFM8	Hex .128"(3.25 mm)
4	.118"(3 mm)	.067"(1.7 mm)	.327"(8.3 mm)	AFM8	Hex .213"(5.41 mm)
10	.118"(3 mm)	.110"(2.8 mm)	.205"(5.2 mm)	AFM8	Hex .128"(3.25 mm)

Please refer to FAKRA catalog for recommended tools.



# Parts Index

Global Part Number	ARFA Part Number	Description	Page
FA1-NXSP-C01-1	FK1121XX-007-NT30G-50	Single Male FAKRA for Cable Group 1	8
FA1-NXSP-C04-1	FK1121XX-008-NT30G-50	Single Male FAKRA for Cable Group 4	8
2FA1-NXSP-C01-1		Single Male FAKRA for Cable Group 1, Second Generation	8
2FA1-NXSP-C04-1		Single Male FAKRA for Cable Group 4, Second Generation	8
FA1-NXSP-C01-0	FK1321XX-007-NT30G-50	Single Male FAKRA with Bracket for Cable Group 1	8
FA1-NXSP-C04-0	FK1321XX-008-NT30G-50	Single Male FAKRA with Bracket for Cable Group 4	8
FA1-NXSP-C01-5	FK1321XX-023-NT30G-50	Single Male Panel Front Mount FAKRA for Cable Group 1	9
FA1-NXSP-C01-6	FK1321XX-026-NT30G-50	Single Male Panel Front Mount FAKRA for Cable Group 1	9
FA1-NXSP-PCB-0	FK1251XX-3GT30G-50	FAKRA Edgecard Male with two lockpins	9
FA1-NXSP-PCB-1	FK1251XX-001-3GT30G-50	FAKRA Edgecard Male	9
FA1-NXSP-PCB-2	FK1251XX-002-3GT30G-50	FAKRA PCB Mount Male	9
FC2-NKERP-PCB-S	FK1252KEW-NT30G-50	FAKRA R/A PCB Mount Male with Bracket	9
FA1-NXRP-PCB-7	FK1252XX-001-3GT30G-50	FAKRA R/A PCB Mount Male	10
FA1-NXRP-PCB-X		FAKRA R/A PCB Mount Male, Extended Nose	10
PSE-LP-PC-8-XX	10058-XX	FAKRA R/A PCB Mount Male	10
FA1-NXRP-PCB-10	FK1252XX-005-NT30G-50	FAKRA R/A PCB Mount Male, Die Cast body	10
FA1-NXRP-PCB-11	FK1252XX-010-NT30G-50	FAKRA R/A SMT PCB Mount Male, Die Cast body	10
FA1-NXRP-PCB-M		FAKRA R/A PCB Mount Male, Die Cast body	10
FA1-NXSP-PCB-X		FAKRA Straight SMT PCB Male, Die Cast body	11
FA2-NXSP-C04-9	FKT1121XX-008-NT30G-50	Dual Male FAKRA for Cable Group 4	11
FA2-NXSP-C01-9	FKT1121XX-007-NT30G-50	Dual Male FAKRA for Cable Group 1	11
FA2-NXSP-C00-9	FKT1121XX-009-NT30G-50	Dual Male FAKRA for Cable Group 0	11
2FA2-NXSP-C04-9		Dual Male FAKRA for Cable Group 4, Second Generation	11
2FA2-NXSP-C01-9		Dual Male FAKRA for Cable Group 1, Second Generation	11
2FA2-NXSP-C00-9		Dual Male FAKRA for Cable Group 0, Second Generation	12
FC2-NEKSP-C01-X	FKT1121EKW-007-NT30G-50	Dual Male FAKRA with Bracket for Cable Group 1	12
FA2-NXSP-C10-0	FKT1321XX-002-NT30G-50	Dual Male FAKRA with Bracket for Cable Group 10	12



Global Part Number	ARFA Part Number	Description	Page
FA2-NXSP-C04-0	FKT1321XX-008-NT30G-50	Dual Male FAKRA with Bracket for Cable Group 4	12
FA2-NXSP-C00-0	FKT1321XX-009-NT30G-50	Dual Male FAKRA with Bracket for Cable Group 0	12
FC2-NCDSP-C00-0	FKT1321CDW-009-NT30G-50	Dual Male FAKRA with Bracket for Cable Group 0	12
FA1-NXRJ-C01-0	FK6112XX-007-NT30G-50	Single R/A Female FAKRA for Cable Group 1	13
FA1-NXRJ-C04-0	FK6112XX-008-NT30G-50	Single R/A Female FAKRA for Cable Group 4	13
2FA1-NXRJ-C01-0	FK6112XX-027-NT30G-50	Single R/A Female FAKRA for Cable Group 1	13
2FA1-NXRJ-C04-0	FK6112XX-028-NT30G-50	Single R/A Female FAKRA for Cable Group 4	13
FA1-NXRJ-C01-3	FK6112XX-037-NT30G-50	360° Rotating Single R/A Female FAKRA for Cable Group 1	13
FA1-NXRJ-C04-3	FK6112XX-038-NT30G-50	360° Rotating Single R/A Female FAKRA for Cable Group 4	13
2FA1-NXSJ-C01-0	FK6121XX-012-NT30G-50	Low-cost Single Female FAKRA for Cable Group 1, Second Generation	14
FA1-NXSJ-C04-0	FK6121XX-008-NT30G-50	Single Female FAKRA for Cable Group 4	14
FA1-NXSJ-C01-0	FK6121XX-007-NT30G-50	Single Female FAKRA for Cable Group 1	14
FA1-NXSJ-C09-0	FK6121XX-003-NT30G-50	Single Female FAKRA for Cable Group 9	14
FA1-NXSJ-C10-0	FK6121XX-002-NT30G-50	Single Female FAKRA for Cable Group 10	14
FA1-NXSJ-C04-6	FK6121XX-010-NT30G-50	Single Female FAKRA with Clip Provision at 6 o'clock for Cable Group 4	14
FA1-NXSJ-C01-6	FK6121XX-005-NT30G-50	Single Female FAKRA with Clip Provision at 6 o'clock for Cable Group 1	15
FA2-NXSJ-C04-0	FKT6121XX-008-NT30G-50	Dual Female FAKRA for Cable Group 4	15
FA2-NXSJ-C01-0	FKT6121XX-007-NT30G-50	Dual Female FAKRA for Cable Group 1	15
FA2-NXSJ-C01-6	FKT6121XX-005-NT30G-50	Dual Female FAKRA with Clip Provision at 6 o'clock for Cable Group 1	15
FA2-NXSJ-C04-6	FKT6121XX-010-NT30G-50	Dual Female FAKRA with Clip Provision at 6 o'clock for Cable Group 4	15
FA2-NXSJ-C00-6	FKT6121XX-011-NT30G-50	Dual Female FAKRA with Clip Provision at 6 o'clock for Cable Group 0	15
021A1		RG 58 Type, Stranded Solid Copper Center Conductor	16
021A8		RG 58 Type-Low Loss, Stranded Solid Copper Center Conductor	16
021G4		RG 58 Type, Stranded Solid Copper Clad Steel Center Conductor	16
025F0		RG 174 Type, Stranded Solid Copper Center Conductor	16
025F7		RG 174 Type-Low Loss, Solid Copper Center Conductor	16
021G1		RG 62 Type-Low Loss, Solid Copper Center Conductor	16