



Chipsmall Limited consists of a professional team with an average of over 10 year of expertise in the distribution of electronic components. Based in Hongkong, we have already established firm and mutual-benefit business relationships with customers from,Europe,America and south Asia,supplying obsolete and hard-to-find components to meet their specific needs.

With the principle of “Quality Parts,Customers Priority,Honest Operation,and Considerate Service”,our business mainly focus on the distribution of electronic components. Line cards we deal with include Microchip,ALPS,ROHM,Xilinx,Pulse,ON,Everlight and Freescale. Main products comprise IC,Modules,Potentiometer,IC Socket,Relay,Connector.Our parts cover such applications as commercial,industrial, and automotives areas.

We are looking forward to setting up business relationship with you and hope to provide you with the best service and solution. Let us make a better world for our industry!



## Contact us

Tel: +86-755-8981 8866 Fax: +86-755-8427 6832

Email & Skype: info@chipsmall.com Web: www.chipsmall.com

Address: A1208, Overseas Decoration Building, #122 Zhenhua RD., Futian, Shenzhen, China





# CSM Series Capacitive Touch Sensor Display 15.0 x 15.0 x 3.2 mm

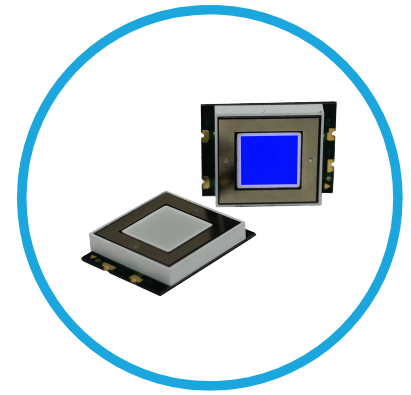

CSMS15CIC06 - Blue Capacitive Touch LED Sensor with a Display Size of 0.59 x 0.59 inches (15 x 15 mm) square

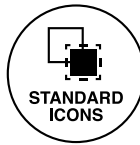

## Application

- Mobile communication devices
- Electronic devices
- Point of sale terminals
- Industrial control displays
- Touch screen monitors
- Media players
- Food service appliances
- Appliances and consumer equipments

## Key features

- Integrated touch sensing and LED display technology
- Enables the device interface to be more user friendly and intuitive
- Allow Top Mount and Reverse Mount design
- Available in one standard size: 15.0mm x 15.00mm x 3.2mm
- Available in 5 colors: super red, white, pure green, blue or yellow
- Touch sensor: integrated circuit (IC)
- Uniform illumination and high optical clarity due to LED technology
- Robust design due to no mechanical moving parts
- Simplifies devices design and manufacturability
- Optional overlay (icons): on/off, arrow, alarm (sold separately)
- Capacitive Touch Display can also be mounted behind clear glass or plastic layer such as polycarbonate or acrylic
- Capacitive sensor still functional when hands are wet
- Capacitive sensor still functional when hands are covered with certain types of gloves

## Ordering Data

The CSM Series ( Capacitive Touch Sensor LED Display ) is available in a range of standard features and options. To specify simply choose one option from each column.

Series	Mounting Type	Shape	Dimension	Polarity	IC	Color
C	SM	S	15	C	IC	
Cap Touch	Surface Mount SM Through-Hole <sup>1</sup> TH	Square	15 mm x 15 mm	Common Cathode	Integrated Circuit	Super Red 01 White 04 Pure Green 05 Blue 06 Yellow 07

<sup>1</sup>For Through-Hole version, please refer to CTH Series Datasheets

## Application Circuit

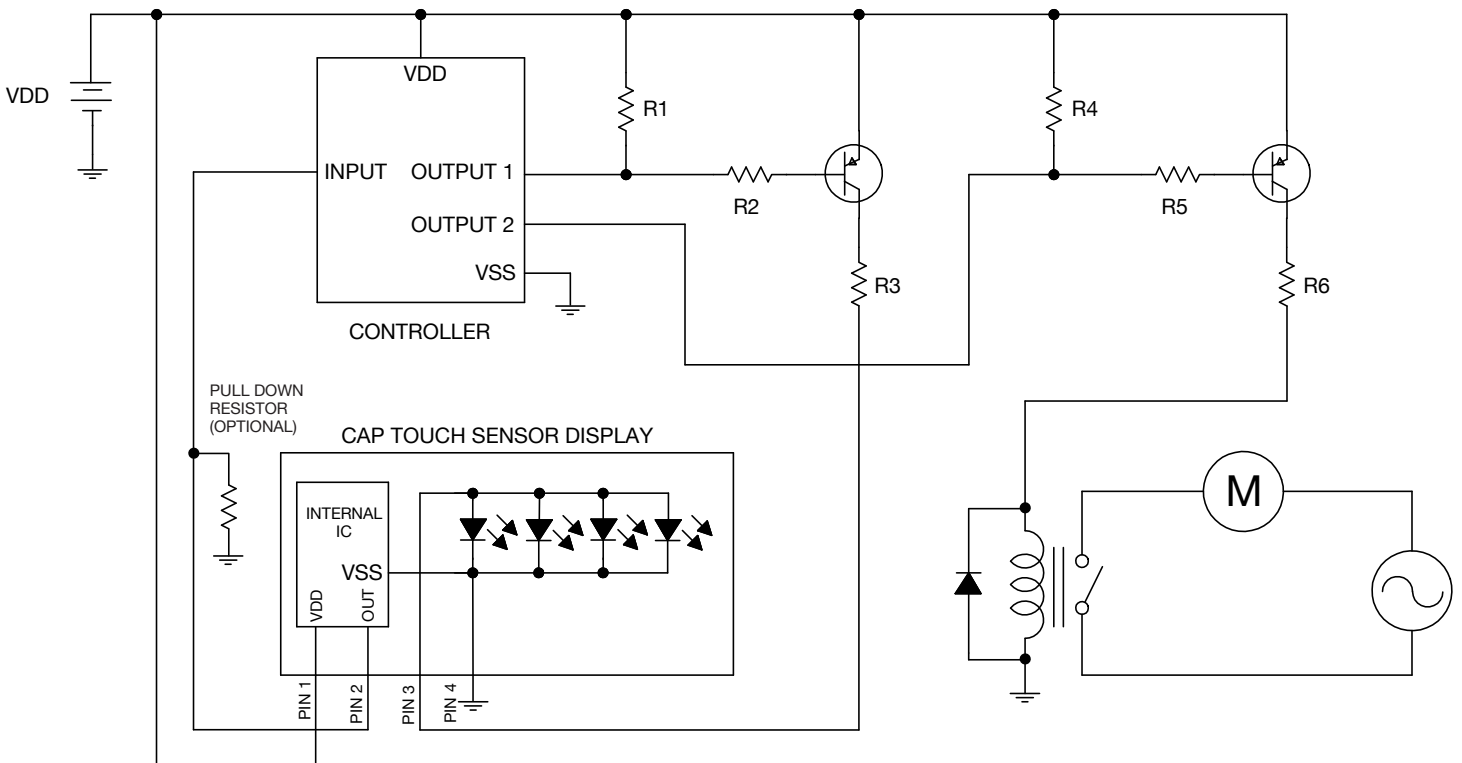

# Package Dimensions

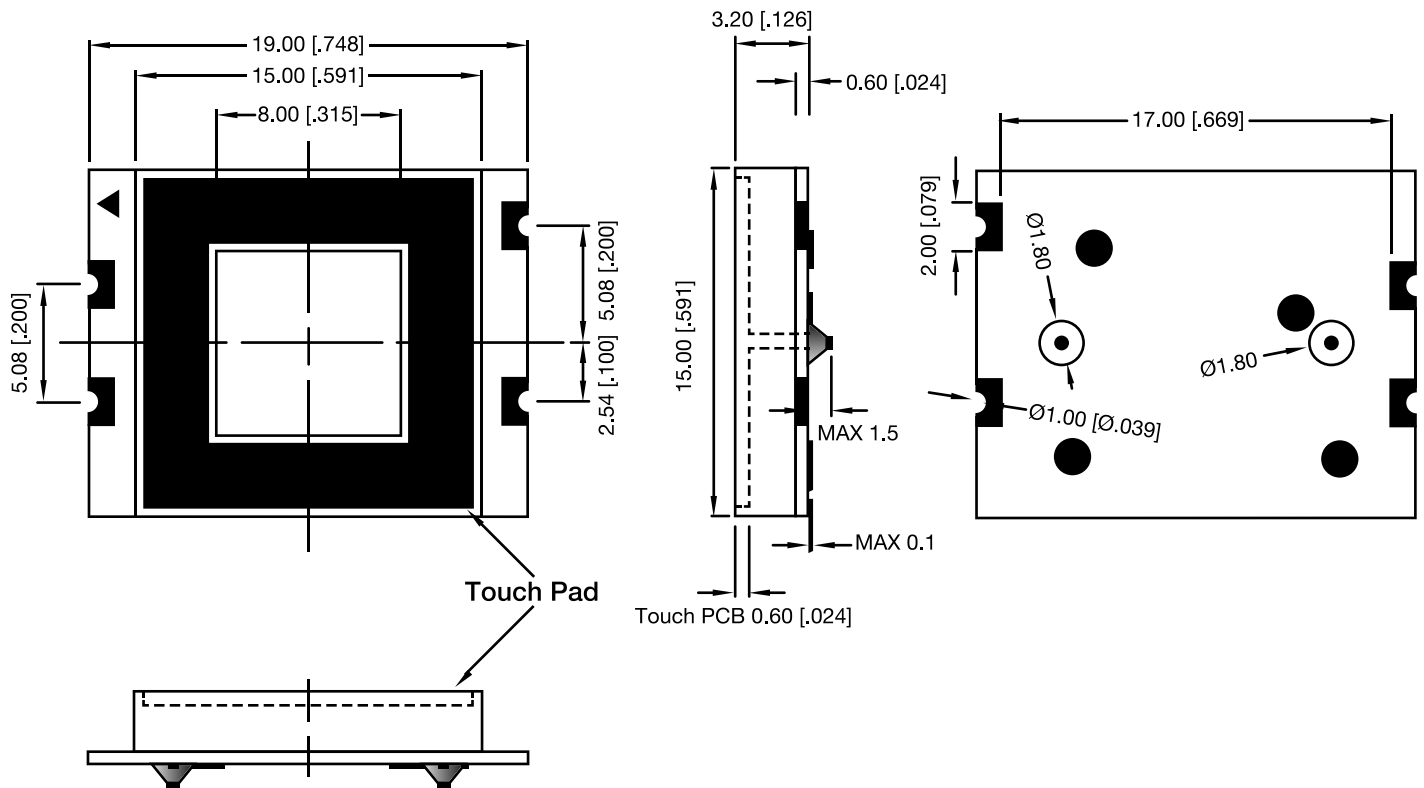

## Notes

- Dimensions are in millimeter [inch]  
Tolerance is  $\pm 0.25$  [0.010] and angle is  $\pm 1^*$  unless otherwise noted

## Features

- Touch Display with Drive IC
- SMD Type
- RoHS Compliant
- Low Power Consumption
- Easy Mounting on P.C. Board or Socket

## Typical Internal Equivalent Circuit

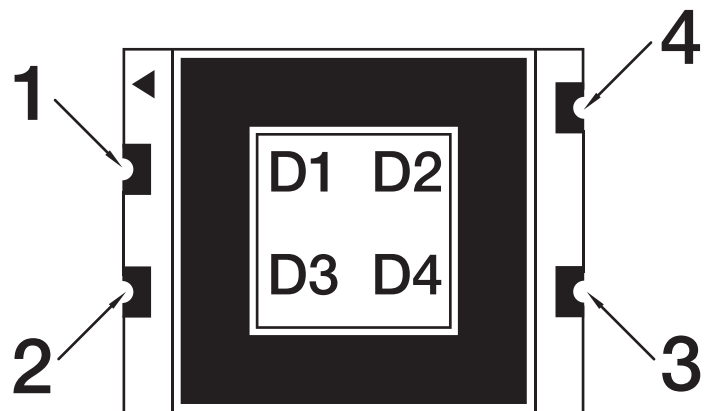

## Internal Circuit Diagram

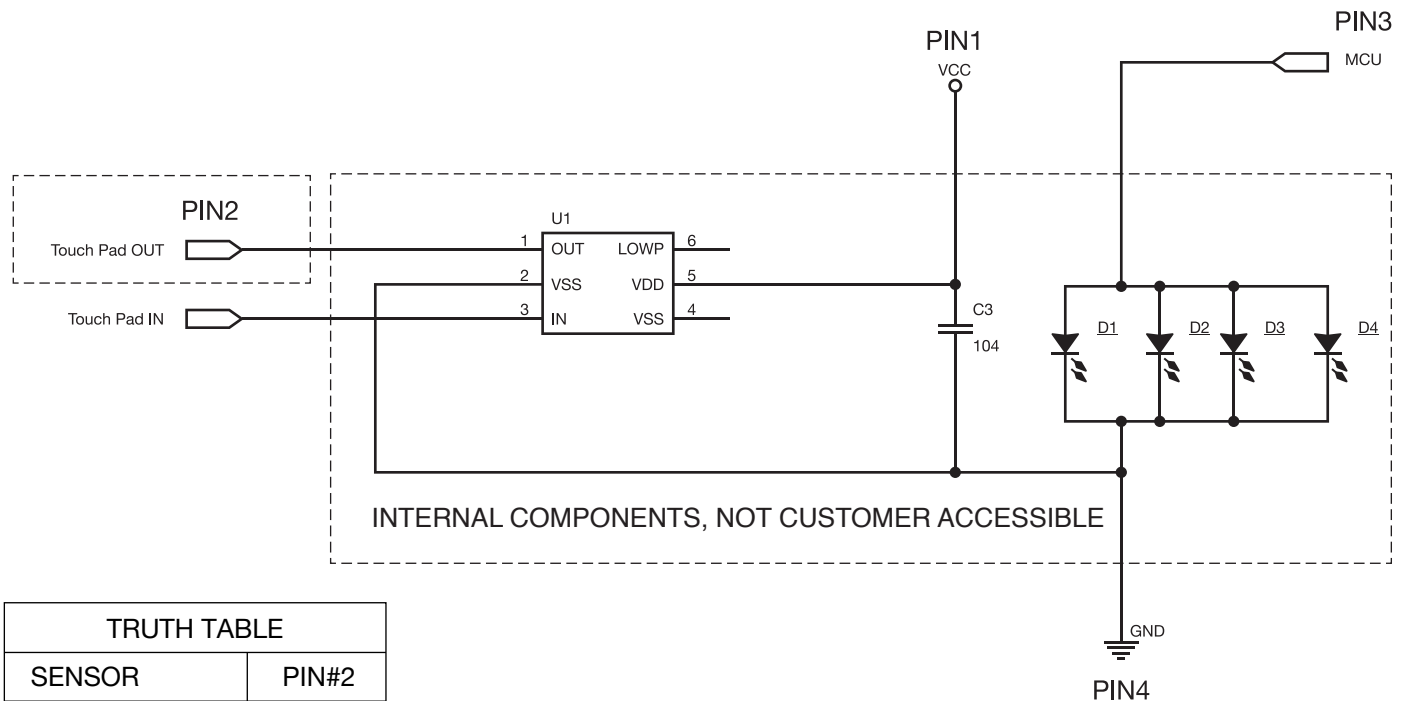

TRUTH TABLE	
SENSOR	PIN#2
NOT TOUCHED	LOW
TOUCHED	HIGH

## Internal IC Electrical Characteristics

(TA = 25°C, unless otherwise specified)

	Symbol	Min.	Typ.	Max.	Unit	Condition
Supply Voltage	$V_{DD}$	2.0	--	5.5	V	--
High Level Input Voltage	$V_{IH}$	3.5	--	5	V	$V_{DD} = 5V$
Low Level Input Voltage	$V_{IL}$	0	--	1.5	V	$V_{DD} = 5V$
Operating Current	$I_{DD1}$	--	16	--	$\mu A$	$V_{DD} = 5V$ No load
		--	3.5	--		$V_{DD} = 3V$ No load
Operating Current (SLRT = $V_{DD}$ )	$I_{DD2}$	--	10.5	--	$\mu A$	$V_{DD} = 5V$ No load
		--	2.5	--		$V_{DD} = 3V$ No load
Low Level Output Current	$I_{OL}$	--	30	--	$mA$	$V_{DD} = 3V$ $V_{OL} = 1V$
High Level Output Current	$I_{OH}$	--	8	--	$mA$	$V_{DD} = 3V$ $V_{OH} = 2V$

## ABSOLUTE MAXIMUM RATING FOR LED

(Ta=25°C)

	Symbol	Rating	Unit
Power Dissipation (Per Dice)	$P_D$	114	mW
Continuous Forward Current (Per Dice)	$I_F$	30	mA
Peak Current (Per Dice, duty cycle 1/10,1KHz)	$I_{FP}$	100	mA
Derating Liner from 25°C (Per Dice)	$\Delta I_F / \Delta T$	0.4	mA / °C
Reverse Voltage (Per Dice)	$V_R$	5	V
Operating Temp.	$T_{OPR}$	-40 ~ +105	°C
Storage Temp.	$T_{STG}$	-40 ~ +105	°C
Electrostatic Discharge (HBM)	ESD	1500	V
Hand Soldering Temperature	$T_{SOL}$	350	°C

## ELECTRO-OPTICAL CHARACTERISTICS

(Ta=25°C)

	Symbol	Min.	Typ.	Max.	Unit	Condition
Luminous Intensity	$I_v$	70	120	--	mcd	$I_F = 20 \text{ mA}$
Forward Voltage	$V_F$	--	3.2	3.8	V	$I_F = 20 \text{ mA}$
Dominant Wavelength	$\lambda_D$	--	465	--	nm	$I_F = 20 \text{ mA}$
Spectrum Radiation Bandwidth	$\Delta\lambda$	--	30	--	nm	$I_F = 20 \text{ mA}$
Reverse Current	$I_R$		-	100	$\mu\text{A}$	$V_R = 5\text{V}$

ELECTRICAL/OPTICAL CHARACTERISTICS CURVES

(Ta=25°C)

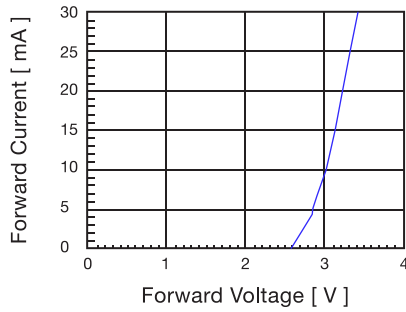

Fig 1. Forward Current vs. Forward Voltage

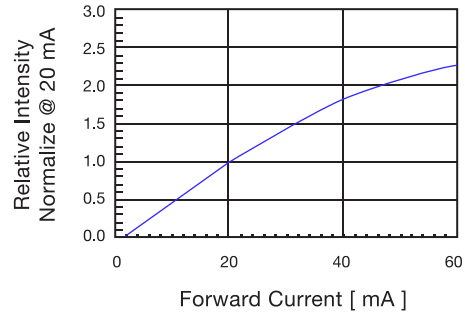

Fig 2. Relative Intensity vs. Forward Current

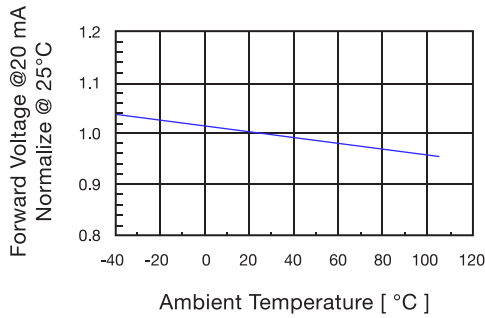

Fig 3. Forward Voltage vs. Temperature

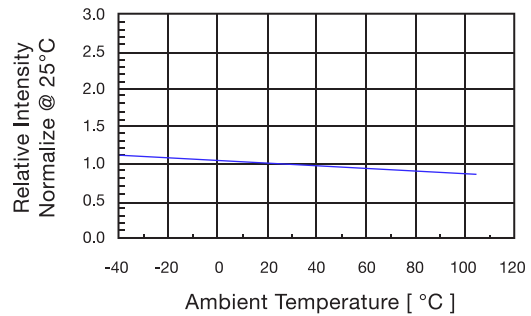

Fig 4. Relative Intensity vs. Temperature

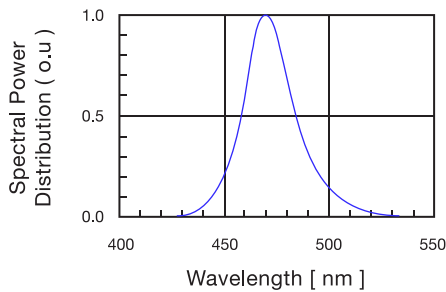

Fig 5. Spectral Power Distribution vs. Wavelength

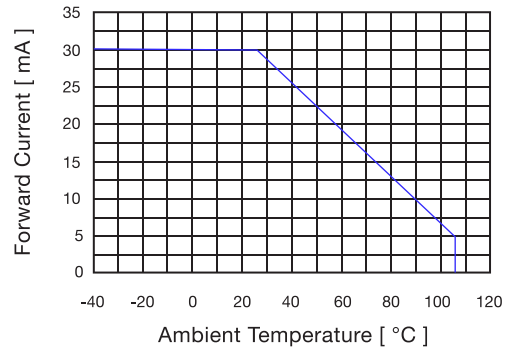
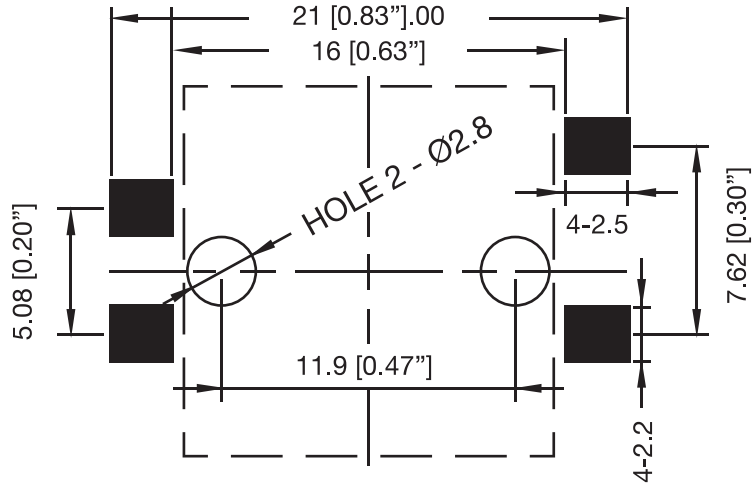
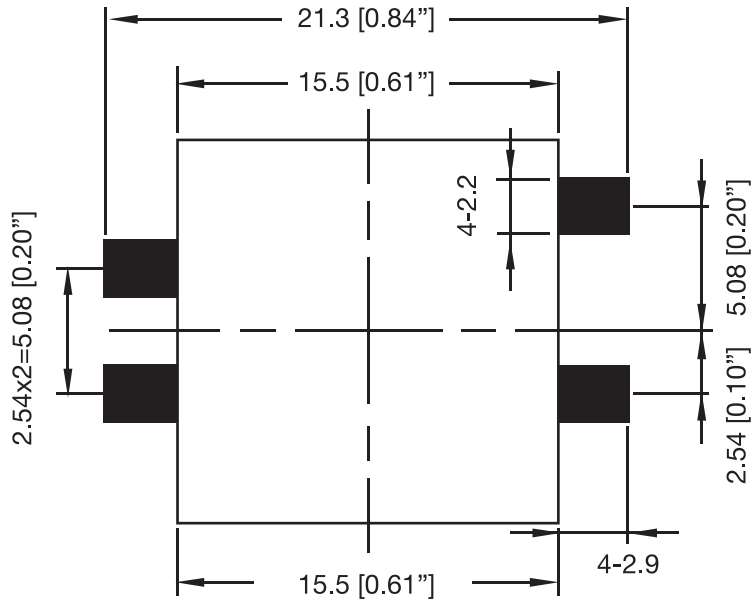

Fig 6. Forward current vs. Temperature

**SOLDERING PAD SIZE**



**Top Mount**



**Reverse Mount**

Dimensions are in millimeter [inch]



**SOLDERING CHARACTERISTICS**

**1. IR-reflow Condition (Pb free)**

Area	Title	Symbol	Min.	Max.	Unit
(1)Preheat	Ramp-up rate	$V_P$	1	5	°C/sec
	Temperature	$T_P$	150	--	°C
	Time	$t_p$	--	--	sec
(2)Equilibrium	Ramp-up rate	$V_E$	--	--	°C/sec
	Temperature	$T_E$	150	200	°C
	Time	$t_e$	60	120	sec
(3)Reflow	Ramp-up rate	$V_R$	1	5	°C/sec
	Temperature	$T_R$	220	--	°C
	Time	$t_r$	--	60	sec
(4)Cooling	Ramp-up rate	$V_{RP}$	--	260	°C
	Temperature	$t_{rp}$	--	10	sec
	Time	$V_C$	3	6	°C/sec

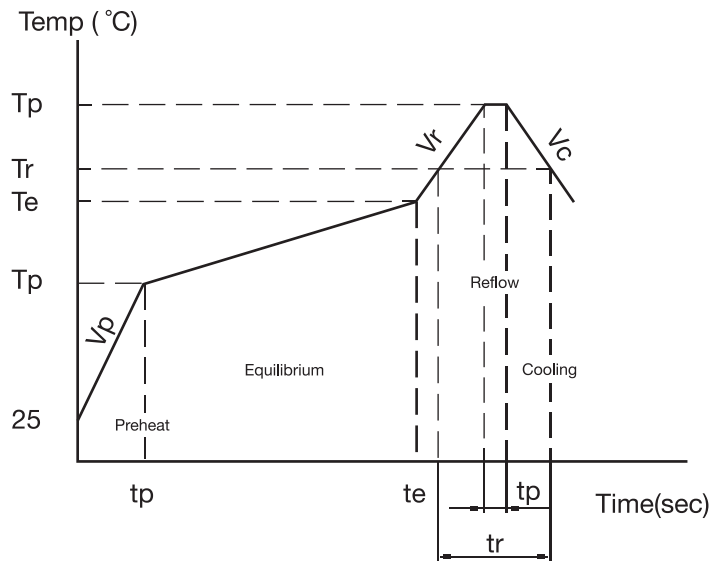

**2. Hand Soldering (Iron Condition)**



Soldering Iron: 30W Max  
 Temperature 350°C Max  
 Soldering Time: 3 Seconds Max (One Time)  
 Distance: 1.6mm min (From Seating Plane)

\* If you choose to add the overlay (optional) it should be applied after reflow

## Overlay (Sold Separately)

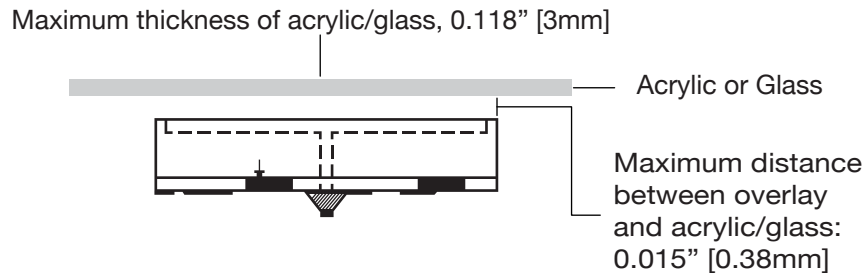
- Standard Icons: Arrow, On/OFF, Alarm
- Icons combines interactive control with color identification to ease and accelerate user interactions for any device
- Reverse printed translucent clear icons for capacitive touch sensor LED backlighting
- Overlay lamination with optically clear adhesive
- Optically clear adhesive for easy installation, high cohesive, and long term durability
- When the CTH or CSM are turned off you can still see the standard icon overlay
- Offers high-temperature capability, high hardness, use resistance, and chemical inertness
- Custom icons are also available upon request [contact a VCC representative]
- Suggested overlay size: 0.590" x 0.590"



Icon	Part Number
	CTHOVERLAYONOFF
	CTHOVERLAYARROW
	CTHOVERLAYALARM

For more information, please refer to the most recent overlay datasheet available on our website

## Overlay Installation Instructions

Before you begin set up your mat and antistatic wrist strap.

Professional service technicians use grounding straps to minimize the chances of electrostatic discharge (ESD) during normal maintenance involving electronic devices.

These antistatic devices may be placed around the wrists or ankles to ground the technician to the system being worked on. These straps release any static present on the technician's body and pass it harmlessly to ground potential.

Use the appropriate equipment.

An antistatic bag is a bag used to store electronic components, which are prone to damage caused electrostatic discharge (ESD).

### Steps:

Note: if using reflow soldering the overlay must be installed afterwards as a second operation

- 1) Peel the overlay (adhesive) off its white sheet without removing the transparent film (**Figure 1**)
- 2) Apply the overlay over the capacitive touch sensor component (**Figure 2**) without removing the protective face line. Be sure to align or orientate the overlay properly.
- 3) Be sure check for no contamination in the ignition zone this can be done with electrical test (**Figure 4,5,6**)
- 4) The protective film can either be removed in the assembly line or by the end user

Figure 1

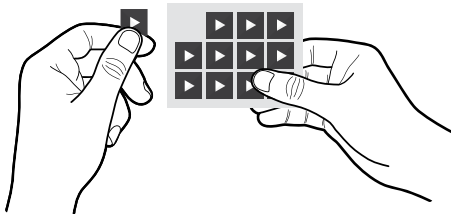

Figure 2

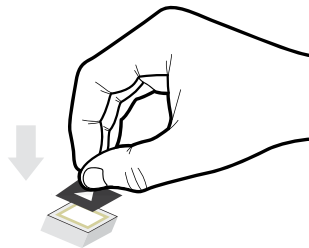

Figure 3

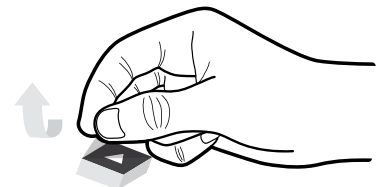

Figure 4

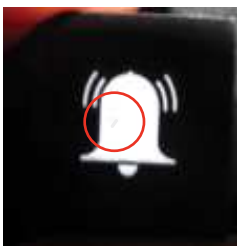
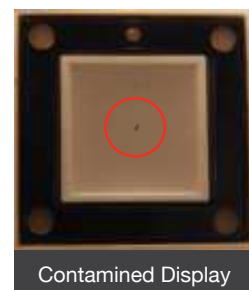

Figure 5



Figure 6



## Storage Method

### • Storage Conditions

#### A. Before opening the package:

The LEDs should be kept at  $-40^{\circ}\text{C} \sim 105^{\circ}\text{C}$  and RH: 45% ~ 85%. The LEDs should be used within a year. When storing the LEDs, moisture proof packaging with absorbent material (silica gel) is recommended.

#### B. After opening the package:

The LEDs should be kept at  $\leq 30^{\circ}\text{C}$  and  $\leq 70\% \text{RH}$ . The LEDs should be soldered within 168 hours (7) after opening the package. If unused LEDs remain, they should be stored in moisture proof packages, such as sealed containers with packages of moisture absorbent material (silica gel). It is also recommended to return the LEDs to the original moisture proof bag and to reseal the moisture proof bag again.

• If the moisture absorbent material (silica gel) has faded away or the LEDs have exceeded the storage time, baking treatment should be performed using the following conditions.

Baking treatment: more than 24 hours at  $65 \pm 5^{\circ}\text{C}$

## Reel Dimension

Dimensions are in millimeter [inch]

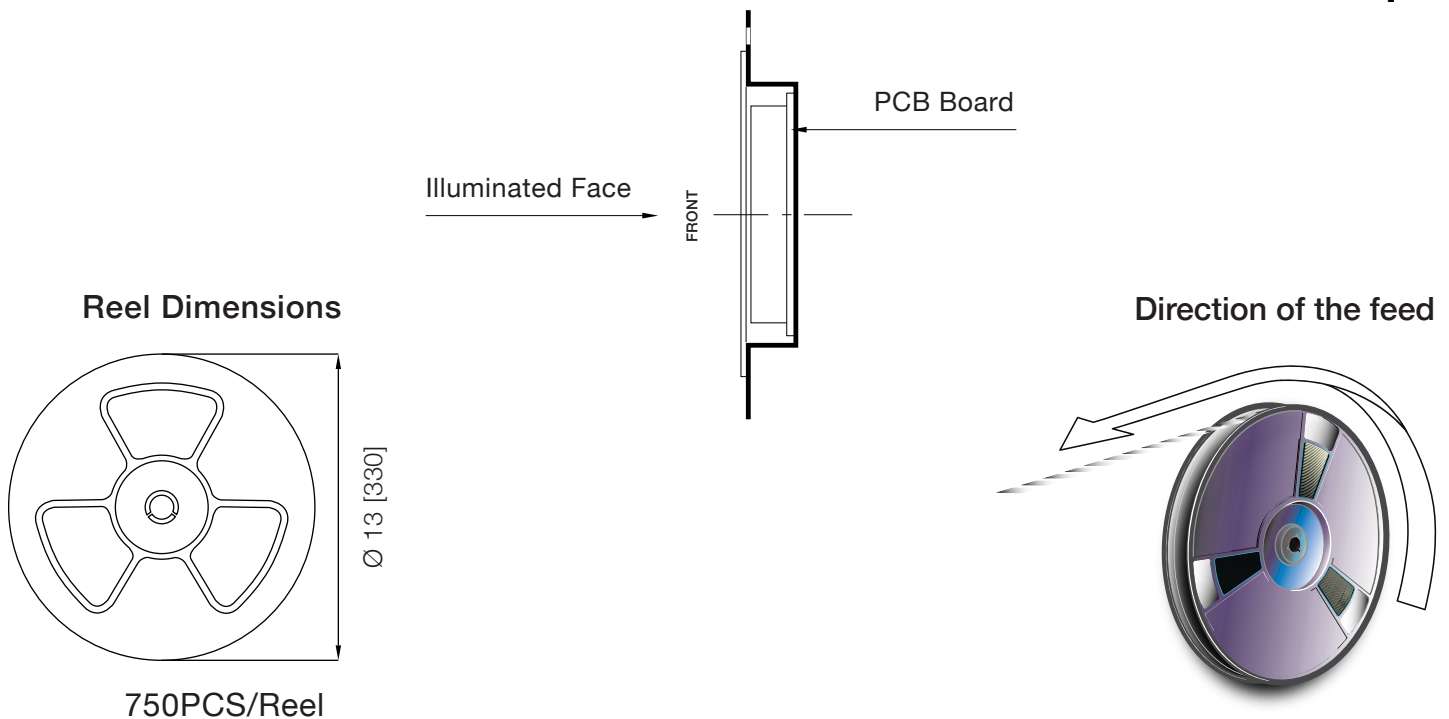

## Compliances and Approvals

