



Chipsmall Limited consists of a professional team with an average of over 10 year of expertise in the distribution of electronic components. Based in Hongkong, we have already established firm and mutual-benefit business relationships with customers from,Europe,America and south Asia,supplying obsolete and hard-to-find components to meet their specific needs.

With the principle of “Quality Parts,Customers Priority,Honest Operation,and Considerate Service”,our business mainly focus on the distribution of electronic components. Line cards we deal with include Microchip,ALPS,ROHM,Xilinx,Pulse,ON,Everlight and Freescale. Main products comprise IC,Modules,Potentiometer,IC Socket,Relay,Connector.Our parts cover such applications as commercial,industrial, and automotives areas.

We are looking forward to setting up business relationship with you and hope to provide you with the best service and solution. Let us make a better world for our industry!



Contact us

Tel: +86-755-8981 8866 Fax: +86-755-8427 6832

Email & Skype: info@chipsmall.com Web: www.chipsmall.com

Address: A1208, Overseas Decoration Building, #122 Zhenhua RD., Futian, Shenzhen, China



Product Type	Current Transformer
AMGIS Part Number	CT1030

SCHEMATIC:

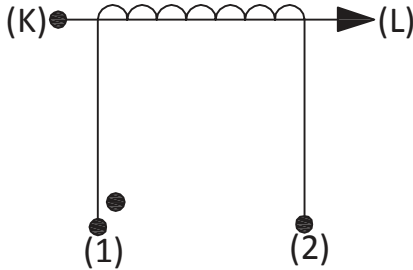

ELECTRICAL SPECIFICATION:

Rated input current	= 30Amps
Primary to Secondary isolation	= 2500VAC
Operating Frequency	= 50 / 60 Hz
Turns Ratio	= 1 : 1000
DC Resistance	= 48.00 Ω
Output Voltage	= 3.0V @ 30A / 100Ω, 0.0900W
Io @ Vrms : 4.38V	= 644μArms
Ratio Correction factor (RCF*)	= 1.02 @ 10% (Multiply current reading by this factor to compensate for transformer losses)

Volt/Amp at rated Ip for different loads			
100Ω	500Ω	2000Ω	5000Ω
0.10	0.47	0.95	1.16

MECHANICAL SPECIFICATION:

OUTPUT RESPONSE vs INPUT CURRENT @ RATED BURDEN :

Pin Side View

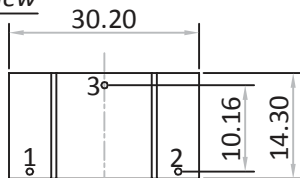

Front View

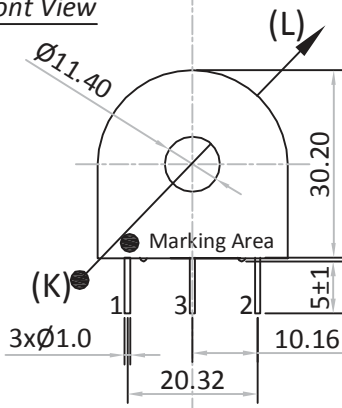

All dimensions are in mm
Linear dimensional tolerance ±0.2mm

Note : Un-Used pin → #3

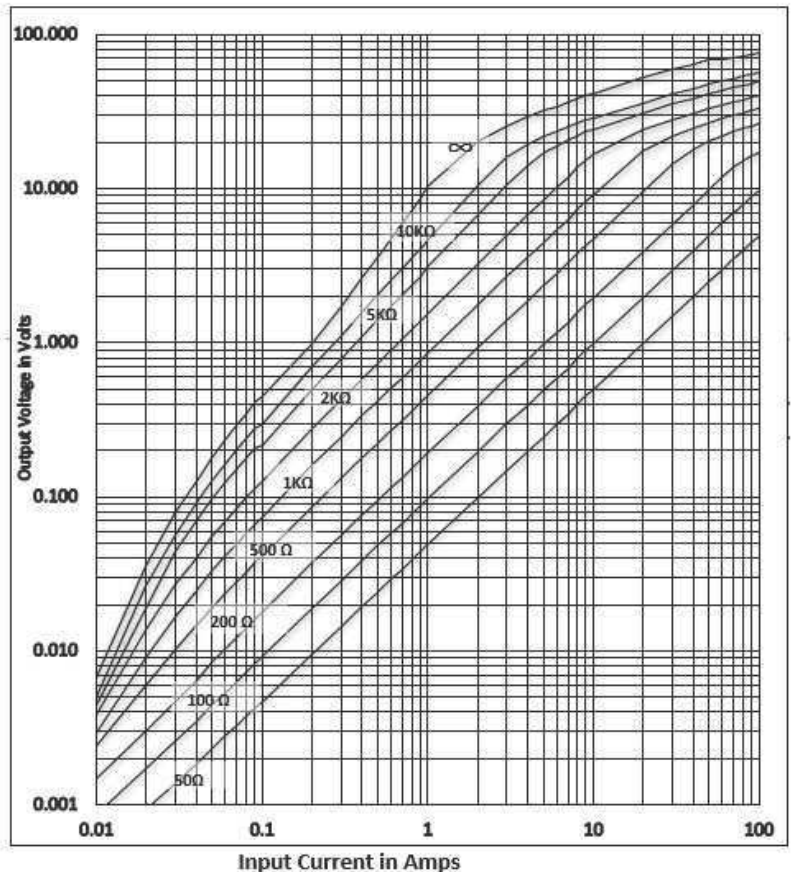

TYPICAL EXCITATION CURVE :

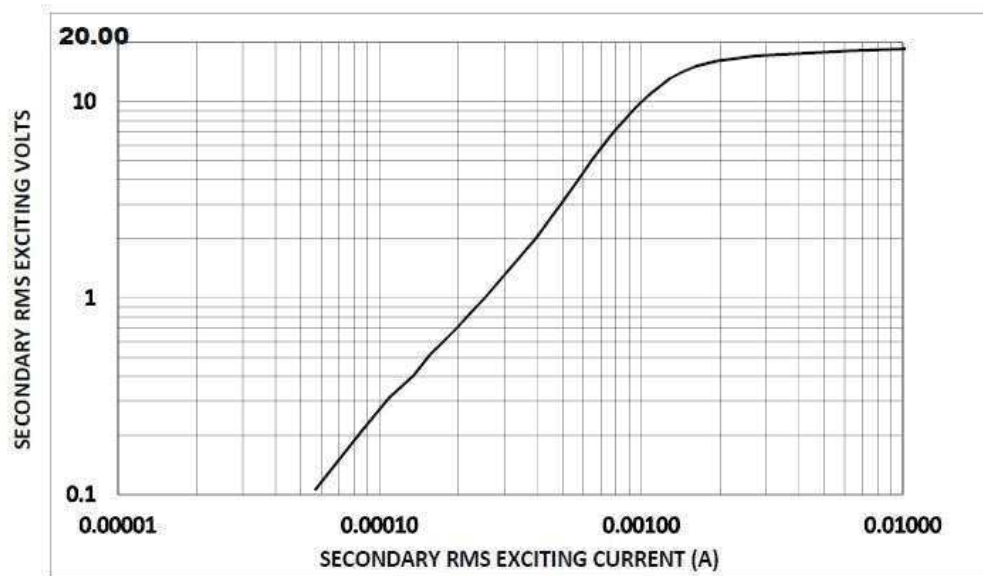

RATIO ERROR (%) vs RATED BURDEN @ INPUT CURRENT :

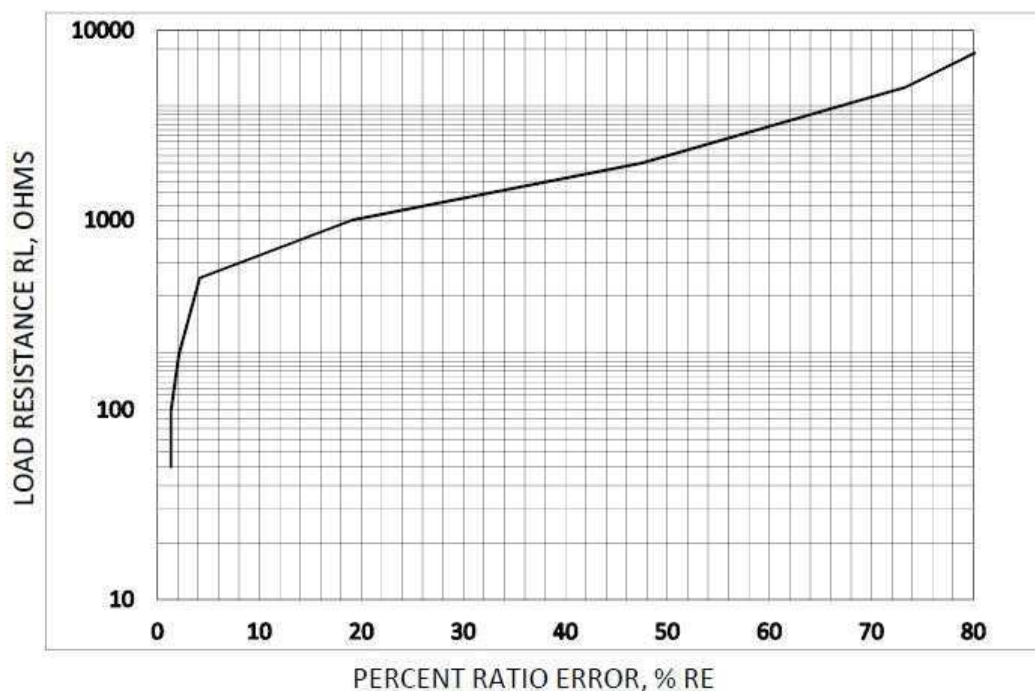

TRAF0 WEIGHT:

Approx. Weight = 0.0355 kg / pc

MARKING INFORMATION:

Amgis
 CT1030
 Yr/Wk code

 Dot mark for Start pin identification

-----Initial Issue-----	1	0	Balaji. R	18-Nov'2015
Changes	Issue	Rev	Initial	Date