



Chipsmall Limited consists of a professional team with an average of over 10 year of expertise in the distribution of electronic components. Based in Hongkong, we have already established firm and mutual-benefit business relationships with customers from,Europe,America and south Asia,supplying obsolete and hard-to-find components to meet their specific needs.

With the principle of "Quality Parts,Customers Priority,Honest Operation,and Considerate Service",our business mainly focus on the distribution of electronic components. Line cards we deal with include Microchip,ALPS,ROHM,Xilinx,Pulse,ON,Everlight and Freescale. Main products comprise IC,Modules,Potentiometer,IC Socket,Relay,Connector.Our parts cover such applications as commercial,industrial, and automotives areas.

We are looking forward to setting up business relationship with you and hope to provide you with the best service and solution. Let us make a better world for our industry!



Contact us

Tel: +86-755-8981 8866 Fax: +86-755-8427 6832

Email & Skype: info@chipsmall.com Web: www.chipsmall.com

Address: A1208, Overseas Decoration Building, #122 Zhenhua RD., Futian, Shenzhen, China





- Completely sealed switching chamber
- Three types of terminals
- UL approved

ELECTRICAL SPECIFICATIONS

- Max. current/voltage rating with resistive load and electrical life at full load: see table below
- Initial contact resistance : 10 mΩ max. at 1A 2VDC
- Insulation resistance : 1.000 MΩ min. at 500VDC
- Dielectric strength : 2.500 Vrms 50 Hz min. between terminals
3.000 Vrms 50 Hz min. between terminals and frame

ELECTRICAL RATING AND LIFE

| | | Alternate current | Direct current | UL |
|-------------|------------------|---|--|--------------------------------------|
| SINGLE POLE | ON-OFF and ON-ON | 15A 125/250VAC resistive 10.000 cycles | 15A 28VDC resistive 5A 28VDC lamp load 10.000 cycles | 10A 125/250 VAC according to UL 1054 |
| | Other functions | 10A 125/250VAC resistive 10.000 cycles | 10.000 cycles, T20°C 15A 28VDC resistive 15A 28VDC inductive 5A 28VDC lamp load | |
| DOUBLE POLE | ON-OFF and ON-ON | 15A 125/250VAC resistive 10.000 cycles | 15A 28VDC resistive 5A 28VDC lamp load 10.000 cycles | |
| | Other functions | 10A 125/250VAC resistive 10.000 cycles | 10.000 cycles, T20°C 15A 28VDC resistive 15A 28VDC inductive 5A 28VDC lamp load | |

MATERIALS

- Case : mineral filled polyester UL94-V0
- Bushing and cover : zamac
- Actuator : bright nickel
- Contacts : silver alloy
Gold plated : on request

AGENCY APPROVAL



File E83438

Availability : consult factory for details of approved models.

Marking : to order switches marked UL, complete appropriate box of ordering format.

GENERAL SPECIFICATIONS

- Torque : 2 Nm (1.47 Ft.lb) max. applied to nut
- Panel thickness : see "Mounting Accessories" on the following pages
- Mechanical life : 100.000 cycles
- Operating temperature : -40°C to +85°C
- Front panel sealing : IP67

CT series

Sealed toggle switches

Overview

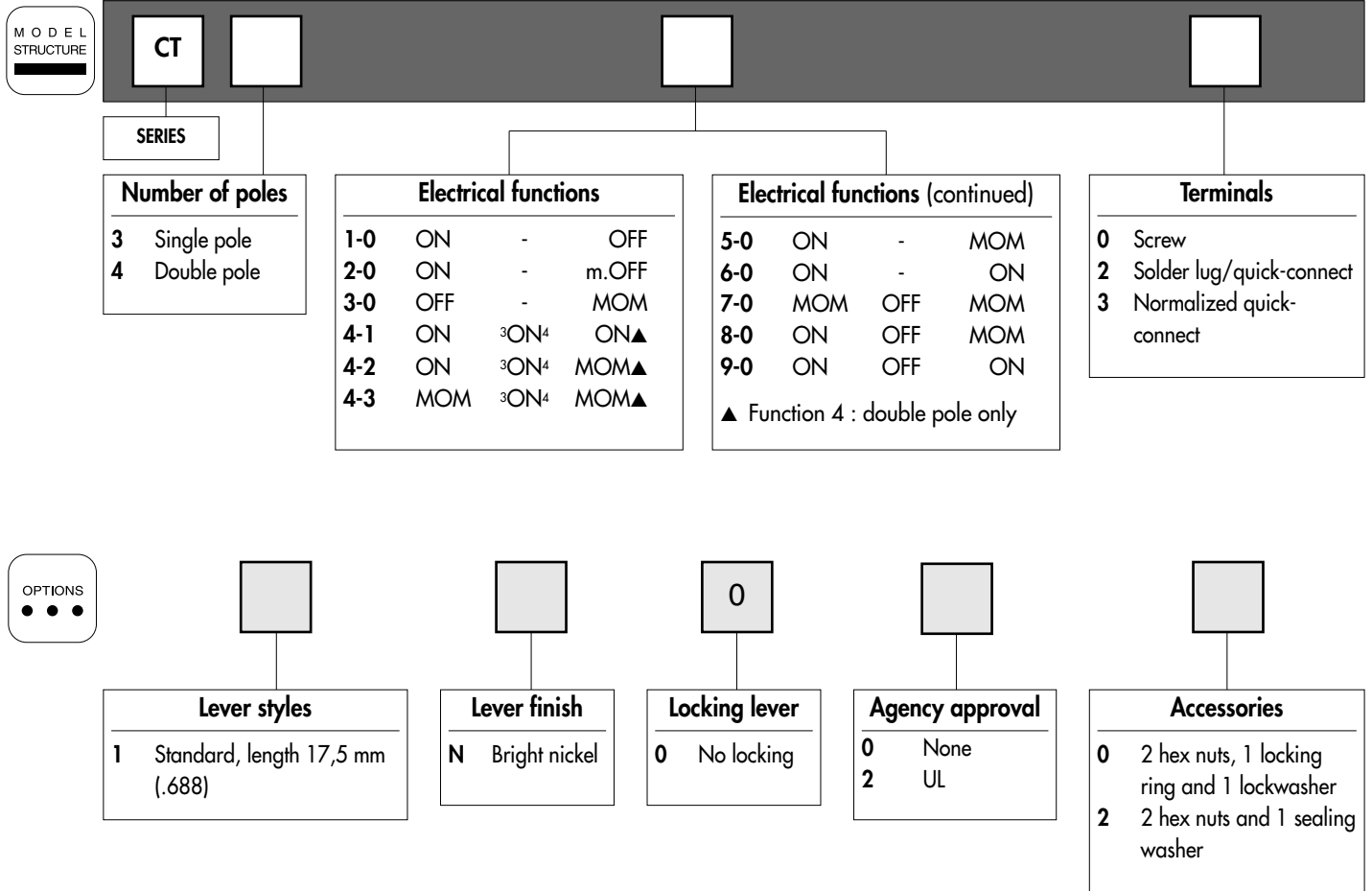

APEM has the ability to develop custom configurations. Please contact us with your requirements.



NOTICE : please note that not all combinations of above numbers are available. Refer to the following pages for further information.

ABOUT THIS SERIES

On the following pages, you will find successively :

- model structure of switches
- their options in the same order as in above chart

Dimensions : first dimensions are in mm while inches are shown as bracketted numbers.

Security caps are available to prevent inadvertent lever operation. On request.



Packaging unit : 25 pieces



CT series

Sealed toggle switches

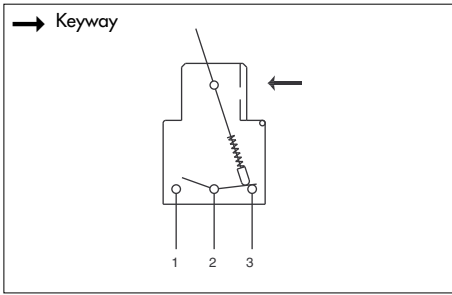

- Screw, solder lug or quick-connect terminals

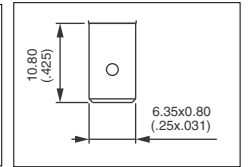
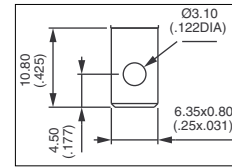
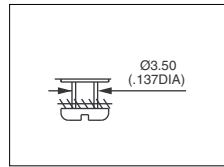

MODEL STRUCTURE

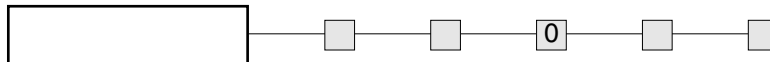

Shown with standard lever



| FUNCTIONS | | | BASIC PART NUMBER | | | | | |
|-----------|--------|-------|-------------------|-------------|-------------------------------------|-------------|------------------------------------|-------------|
| III | II | I | Screw terminals | | Solder lugs and quick-connect term. | | Normalized quick-connect terminals | |
| A2-A3 | *A3-B4 | A1-A2 | Single pole | Double pole | Single pole | Double pole | Single pole | Double pole |
| B5-B6 | A1-B6 | B5-B4 | | | | | | |
| ON | - | OFF | CT31-00 | CT41-00 | CT31-02 | CT41-02 | CT31-03 | CT41-03 |
| ON | - | m.OFF | CT32-00 | CT42-00 | CT32-02 | CT42-02 | CT32-03 | CT42-03 |
| OFF | - | MOM | CT33-00 | CT43-00 | CT33-02 | CT43-02 | CT33-03 | CT43-03 |
| ON | ON* | ON | | CT44-10 | | CT44-12 | | CT44-13 |
| ON | ON* | MOM | | CT44-20 | | CT44-22 | | CT44-23 |
| MOM | ON* | MOM | | CT44-30 | | CT44-32 | | CT44-33 |
| ON | - | MOM | CT35-00 | CT45-00 | CT35-02 | CT45-02 | CT35-03 | CT45-03 |
| ON | - | ON | CT36-00 | CT46-00 | CT36-02 | CT46-02 | CT36-03 | CT46-03 |
| MOM | OFF | MOM | CT37-00 | CT47-00 | CT37-02 | CT47-02 | CT37-03 | CT47-03 |
| ON | OFF | MOM | CT38-00 | CT48-00 | CT38-02 | CT48-02 | CT38-03 | CT48-03 |
| ON | OFF | ON | CT39-00 | CT49-00 | CT39-02 | CT49-02 | CT39-03 | CT49-03 |

→ Keyway

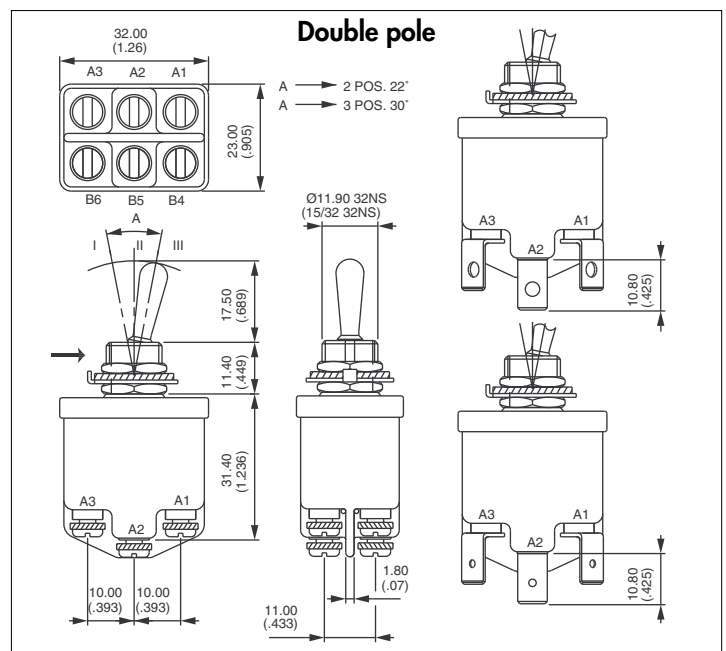
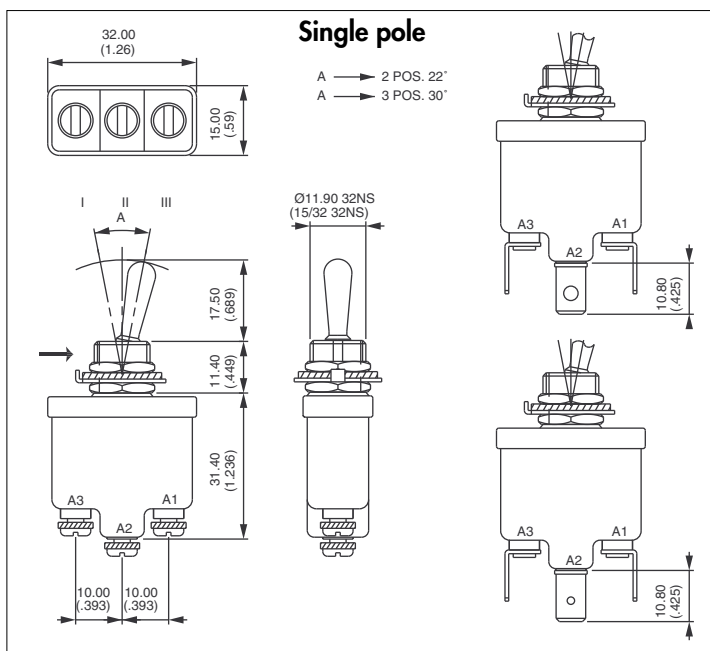

CT series

Sealed toggle switches

OPTIONS



LEVER STYLES

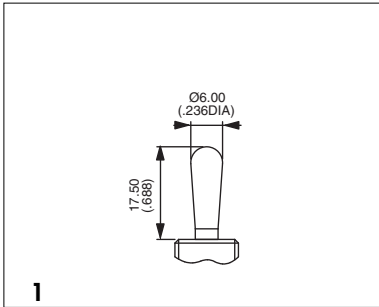
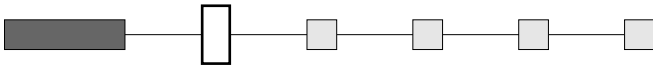

Standard

LEVER FINISH

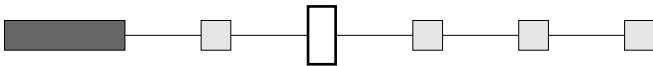

N Bright nickel

LOCKING LEVER

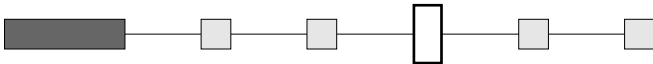

0 No locking

AGENCY APPROVAL

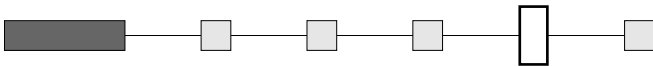

0 None
2 UL

APEM has the ability to develop custom configurations. Please contact us with your requirements.



CT series

Sealed toggle switches

MOUNTING ACCESSORIES

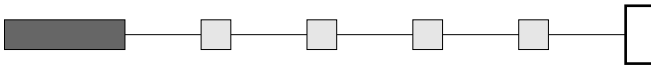

- 0 For NON-SEALED mounting (panel cut-out fig. 1, 2 or 3)
2 hex nuts 14 mm (.551) across flats, 1 locking ring U121 or U12, 1 lockwasher U13
Panel thickness : 5 mm (.196) max.
- 2 For SEALED mounting (panel cut-out fig. 2)
2 hex nuts 14 mm (.551) across flats and 1 sealing washer U60
Panel thickness : 4 mm (.157) max.

Special hardware : black cap nut U129. Order separately.

