



Chipsmall Limited consists of a professional team with an average of over 10 year of expertise in the distribution of electronic components. Based in Hongkong, we have already established firm and mutual-benefit business relationships with customers from,Europe,America and south Asia,supplying obsolete and hard-to-find components to meet their specific needs.

With the principle of “Quality Parts,Customers Priority,Honest Operation,and Considerate Service”,our business mainly focus on the distribution of electronic components. Line cards we deal with include Microchip,ALPS,ROHM,Xilinx,Pulse,ON,Everlight and Freescale. Main products comprise IC,Modules,Potentiometer,IC Socket,Relay,Connector.Our parts cover such applications as commercial,industrial, and automotives areas.

We are looking forward to setting up business relationship with you and hope to provide you with the best service and solution. Let us make a better world for our industry!



Contact us

Tel: +86-755-8981 8866 Fax: +86-755-8427 6832

Email & Skype: info@chipsmall.com Web: www.chipsmall.com

Address: A1208, Overseas Decoration Building, #122 Zhenhua RD., Futian, Shenzhen, China



CTS100LVEL58

LVPECL 2:1 Multiplexer

MLP8, MSOP8, SOIC8

Not recommended for new designs

FEATURES

- 440ps Propagation Delay
- Operating Voltage of 3.0 to 5.5V
- Internal Input Pull-down Resistors
- Direct Replacement for ON Semi MC100LVEL58
- ROHS Compliant Pb Free Packages

BLOCK DIAGRAM

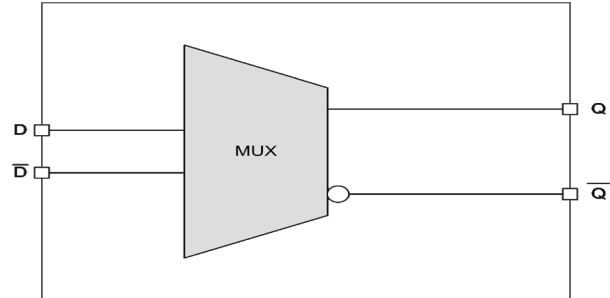

DESCRIPTION

The CTS100LVEL58 is a 2:1 multiplexer. The device is pin and functionally equivalent to the CTS100EL58. With AC performance similar to the CTS100EL58 device, the LVEL58 is ideal for the low voltage applications that require the ultimate in AC performance. If desired, the select input can be directly driven from a CMOS output.

The CTS100LVEL58 is a direct replacement for the ON Semi MC100LVEL58.

ENGINEERING NOTES

Functionality Table

SEL	Q
HIGH	D0
LOW	D1

ELECTRICAL SPECIFICATIONS

Absolute Maximum Ratings are those values beyond which device life may be impaired.

Symbol	Characteristic	Condition	Rating	Unit
V_{CC}	PECL Power Supply	$V_{EE} = 0V$	0 to +8.0	V
V_I	PECL Input Voltage	$V_{EE} = 0V$	0 to +6.0	V
V_{EE}	ECL Power Supply	$V_{CC} = 0V$	-8.0 to 0	V
V_I	ECL Input Voltage	$V_{CC} = 0V$	-6.0 to 0	V
I_{OUT}	Output Current	Continuous	50	mA
		Surge	100	
T_A	Operating Temperature Range		-40 to +85	°C
T_{STG}	Storage Temperature Range		-65 to +150	°C
ESD_{HBM}	Human Body Model		2500	V
ESD_{MM}	Machine Model		200	V
ESD_{CDM}	Charged Device Model		2500	V

ECL DC Characteristics ($V_{EE} = -3.0V$ to $-5.5V$, $V_{CC} = GND$)

Symbol	Characteristic	-40 °C			0 °C			25 °C			85 °C			Unit
		Min	Typ	Max	Min	Typ	Max	Min	Typ	Max	Min	Typ	Max	
V_{OH}	Output HIGH Voltage ¹	-1085	-1005	-880	-1025	-955	-880	-1025	-955	-880	-1025	-955	-880	mV
V_{OL}	Output LOW Voltage ¹	-1830	-1695	-1555	-1810	-1705	-1620	-1810	-1705	-1620	-1810	-1705	-1620	mV
V_{IH}	Input HIGH Voltage	-1165		-880	-1165		-880	-1165		-880	-1165		-880	mV
V_{IL}	Input LOW Voltage	-1810		-1475	-1810		-1475	-1810		-1475	-1810		-1475	mV
I_{IH}	Input HIGH Current			150			150			150			150	µA
I_{IL}	Input LOW Current	-150			-150			-150			-150			µA
I_{EE}	Power Supply Current		21	28		21	28		21	28		23	30	mA

¹ Each output is terminated through a 50Ω resistor to $V_{CC} - 2V$.

LVPECL DC Characteristics ($V_{EE} = \text{GND}$, $V_{CC} = +3.3\text{V}$)

Symbol	Characteristic	-40 °C			0 °C			25 °C			85 °C			Unit
		Min	Typ	Max	Min	Typ	Max	Min	Typ	Max	Min	Typ	Max	
V_{OH}	Output HIGH Voltage ¹	2215	2295	2420	2275	2345	2420	2275	2345	2420	2275	2345	2420	mV
V_{OL}	Output LOW Voltage ¹	1470	1605	1745	1490	1595	1680	1490	1595	1680	1490	1595	1680	mV
V_{IH}	Input HIGH Voltage	2135		2420	2135		2420	2135		2420	2135		2420	mV
V_{IL}	Input LOW Voltage	1490		1825	1490		1825	1490		1825	1490		1825	mV
I_{IH}	Input HIGH Current			150			150			150			150	μA
I_{IL}	Input LOW Current	-150			-150			-150			-150			μA
I_{EE}	Power Supply Current		21	28		21	28		21	28		23	30	mA

¹ Each output is terminated through a 50Ω resistor to $V_{CC} - 2\text{V}$.

PECL DC Characteristics ($V_{EE} = \text{GND}$, $V_{CC} = +5.0\text{V}$)

Symbol	Characteristic	-40 °C			0 °C			25 °C			85 °C			Unit
		Min	Typ	Max	Min	Typ	Max	Min	Typ	Max	Min	Typ	Max	
V_{OH}	Output HIGH Voltage ¹	3915	3995	4120	3975	4045	4120	3975	4045	4120	3975	4045	4120	mV
V_{OL}	Output LOW Voltage ¹	3170	3305	3445	3190	3295	3380	3190	3295	3380	3190	3295	3380	mV
V_{IH}	Input HIGH Voltage	3835		4120	3835		4120	3835		4120	3835		4120	mV
V_{IL}	Input LOW Voltage	3190		3525	3190		3525	3190		3525	3190		3525	mV
I_{IH}	Input HIGH Current			150			150			150			150	μA
I_{IL}	Input LOW Current	-150			-150			-150			-150			μA
I_{EE}	Power Supply Current		27	33		27	33		27	33		31	37	mA

¹ Each output is terminated through a 50Ω resistor to $V_{CC} - 2\text{V}$.

AC Characteristics ($V_{EE} = -3.0V$ to $-5.5V$, $V_{CC} = GND$ or $V_{EE} = GND$, $V_{CC} = +3.0V$ to $+5.0V$)

Symbol	Characteristic	-40 °C			0 °C			25 °C			85 °C			Unit
		Min	Typ	Max	Min	Typ	Max	Min	Typ	Max	Min	Typ	Max	
t_{PLH}/t_{PHL}	Propagation Delay to Output - D to Q	340	435	560				350	440	570	370	450	590	ps
	SEL to Q	540	455	570				360	460	580	380	470	600	ps
f_{MAX}	Max Toggle Freq							1.5						GHz
t_R/t_F	Output Rise/Fall Times Q (20%-80%)	100		260	100		260	100		260	100		260	ps

Pin Description and Configuration
Pin Assignments

Pin	Name	Type	Function
1	NC		
2	D0	Input	Data Input
3	D1	Input	Data Input
4	SEL	Input	Select Input
5	V_{EE}	Power	Negative Supply
6	\overline{Q}	Output	Data Output
7	Q	Output	Data Output
8	V_{CC}	Power	Positive Supply

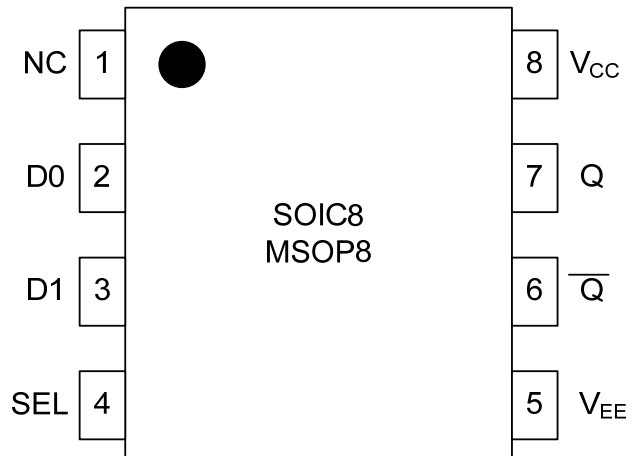
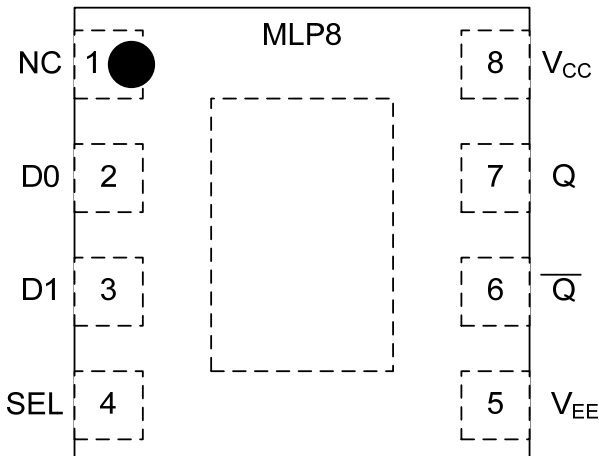

CTS100LVEL58

LVPECL 2:1 Multiplexer

MLP8, MSOP8, SOIC8

Not recommended for new designs

PACKAGE DIMENSIONS

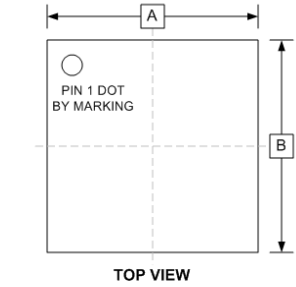

MLP8 (N)

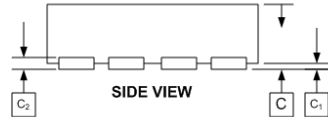
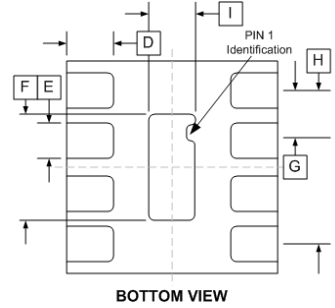

MILLIMETERS		
DIM	MIN	MAX
A	2.00±0.050	
B	2.00±0.050	
C	0.75±0.050	
C ₁	0.00	0.05
C ₂	0.203	Ref.
D	0.35±0.050	
E	0.25±0.050	
F	1.20±0.050	
G	0.500	BSC
H	1.500	REF
I	0.60±0.050	

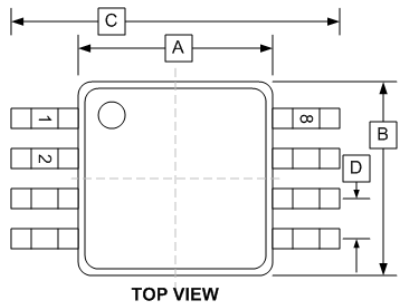
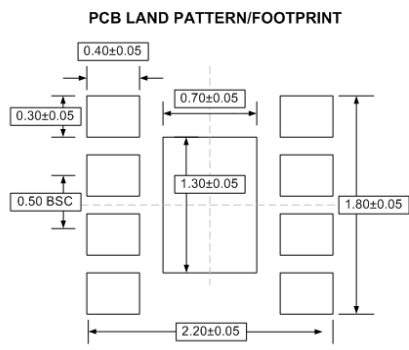

MSOP8 (T)

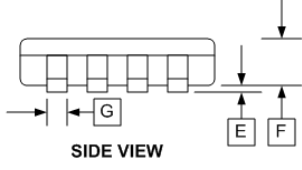
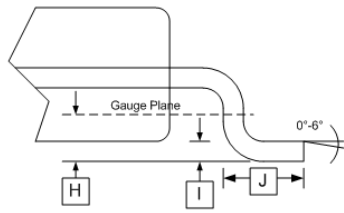

INCHES		
DIM	MIN	MAX
A	0.118±0.004	
B	0.118±0.004	
C	0.192±0.008	
D	0.0256	TYP
E	0.004±0.002	
F	0.034±0.002	
G	0.009±0.014	
H	0.010	
I	0.006±0.002	
J	0.021±0.004	

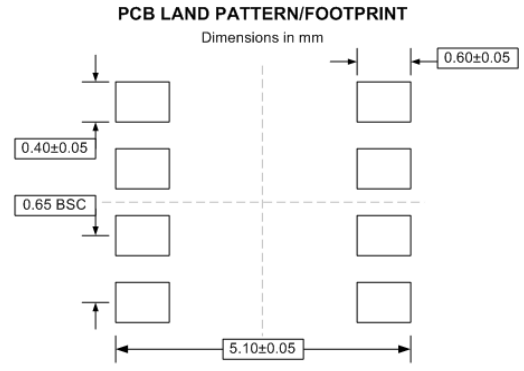

CTS100LVEL58
LVPECL 2:1 Multiplexer
 MLP8, MSOP8, SOIC8

Not recommended for new designs

PACKAGE DIMENSIONS

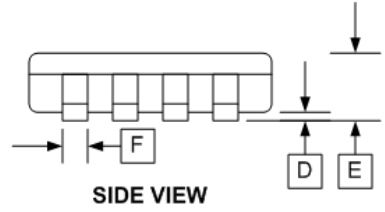
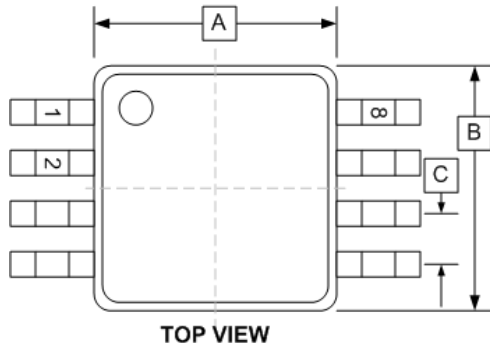

DIM	mm	
	MIN	MAX
A	3.81	3.99
B	4.80	4.98
C	1.27 BSC	
D	0.10	0.25
E	1.37	1.68
F	0.36	0.48
G	0.25	
H	0.19	0.25
I	0.41	0.86

SOIC8 (D)

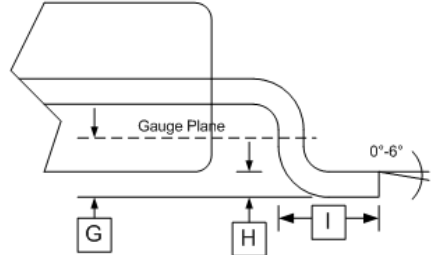

PCB LAND PATTERN/FOOTPRINT

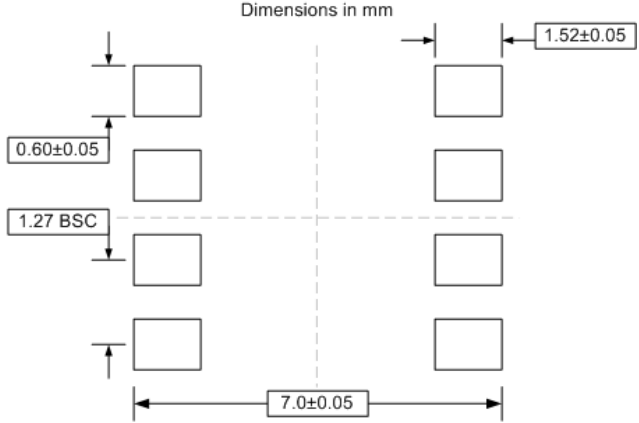

PART ORDERING INFORMATION

Part Number	Package	Marking
CTS100LVEL58DG	SOIC8	CTS100G / LVEL58 / YYWW
CTS100LVEL58TG	MSOP8	HL58G / YYWW
CTS100LVEL58NG	MLP8	L5G / YWW