



Chipsmall Limited consists of a professional team with an average of over 10 year of expertise in the distribution of electronic components. Based in Hongkong, we have already established firm and mutual-benefit business relationships with customers from,Europe,America and south Asia,supplying obsolete and hard-to-find components to meet their specific needs.

With the principle of “Quality Parts,Customers Priority,Honest Operation,and Considerate Service”,our business mainly focus on the distribution of electronic components. Line cards we deal with include Microchip,ALPS,ROHM,Xilinx,Pulse,ON,Everlight and Freescale. Main products comprise IC,Modules,Potentiometer,IC Socket,Relay,Connector.Our parts cover such applications as commercial,industrial, and automotives areas.

We are looking forward to setting up business relationship with you and hope to provide you with the best service and solution. Let us make a better world for our industry!



Contact us

Tel: +86-755-8981 8866 Fax: +86-755-8427 6832

Email & Skype: info@chipsmall.com Web: www.chipsmall.com

Address: A1208, Overseas Decoration Building, #122 Zhenhua RD., Futian, Shenzhen, China



GENERAL

Coiltronics 1210 Series Chip Inductors are ideally suited for signal and moderate power circuit SMT applications. Both the CTX32 and CTX32C Product Families are designed to provide superior reliability due to their rugged ceramic case construction. Precise manufacturing processes provide mechanically sound devices which maintain tolerance specifications. The devices are supplied in 8 mm tape and reel packaging which facilitates automatic assembly insertion.



Coiltronics designs and manufactures many standard and custom electro-magnetic components. Contact the factory or your nearest Coiltronics representative or distributor with your transformer and inductor requirements.

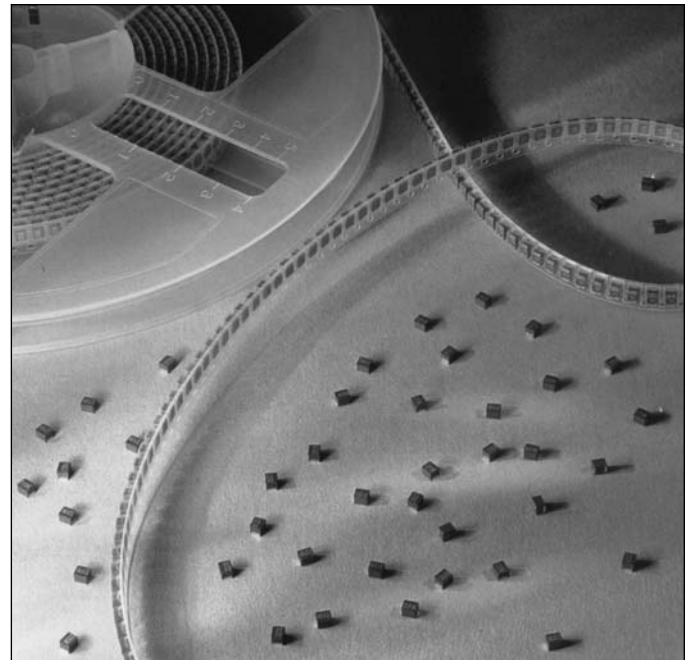

CONSTRUCTION DIMENSIONS

- Operating Temperature Range: -25°C to +85°C
- Storage Temperature Range: -40°C to +125°C
- Resistance to Soldering: Can withstand +260°C for up to 10 seconds
- Resistance to Solvents: Conforms to MIL-STD-202E
- Coefficient of Expansion: 6.7 x 10⁻⁶ppm/°C (typical)
- Insulation Resistance: 1000 Mohms minimum
- Flammability: Conforms to IEC 695-2-2

FEATURE - BENEFITS

- 1210 Series from factor means small footprint and low profile for high density applications
- High Q Rating assures performance reliability
- Tape and Reel Packaging for automatic assembly insertion
- Precision ceramic casing allows high temperature surface mounting and excellent thermal conduction
- Triple-plated terminals enhance reliable solderability
- Available in inductance ranges from 0.1 to 470 µH
- Low cost with high performance

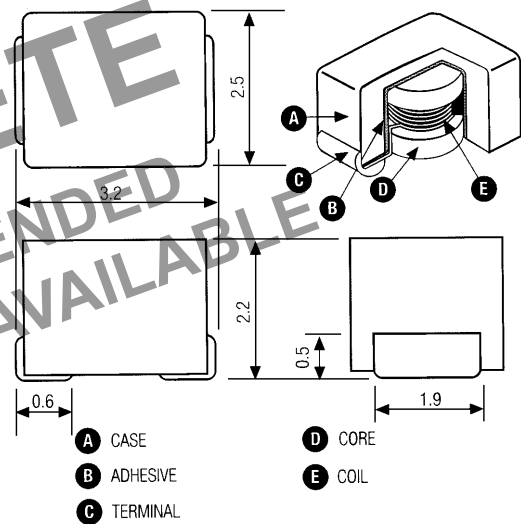

RECOMMENDED PAD LAYOUT PATTERN

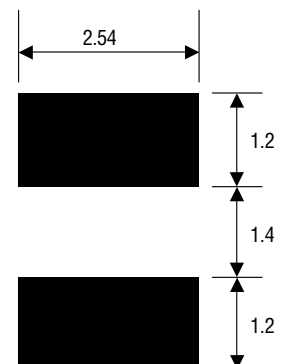

All dimensions in mm. Pad layout dimensions are nominal.

ORDERING INFORMATION

CTX32 and CTX32X Product Families are supplied in 8mm tape and reel packaging. Each reel contains 2000 inductors.

CTX32 Product Family

CTX32 Product Family Chip Inductors are ideally suited for low level signal circuit applications.

Coiltronics Part Number	Inductance $\mu\text{H}/\text{TOL}$	Q Min	Test MHz	SRF Min. MHz	R_{DC} Max. Ohms	I_{DC} Rated mA
CTX32T-R12-R	0.12+/-20%	30	25.2	500	.22	450
CTX32T-R15-R	0.15			450	.25	450
CTX32T-R18-R	0.18			400	.28	450
CTX32T-R22-R	0.22			350	.32	450
CTX32T-R27-R	0.27			320	.36	450
CTX32T-R33-R	0.33			300	.40	450
CTX32T-R39-R	0.39			250	.45	450
CTX32T-R47-R	0.47			220	.50	450
CTX32T-R56-R	0.56			180	.55	450
CTX32T-R68-R	0.68			160	.60	450
CTX32T-R82-R	0.82			140	.65	450
CTX32T-1R0-R	1.0		7.96	120	.70	400
CTX32T-1R2-R	1.2			100	.75	390
CTX32T-1R5-R	1.5			85	.85	370
CTX32T-1R8-R	1.8			80	.90	350
CTX32T-2R2-R	2.2			75	1.00	320
CTX32T-2R7-R	2.7			70	1.10	290
CTX32T-3R3-R	3.3			60	1.20	260
CTX32T-3R9-R	3.9			55	1.30	250
CTX32T-4R7-R	4.7			50	1.50	220
CTX32T-5R6-R	5.6			47	1.60	200
CTX32T-6R8-R	6.8			43	1.80	180
CTX32T-8R2-R	8.2			40	2.00	170
CTX32T-100-R	10.0+/-10%		2.52	36	2.10	150
CTX32T-120-R	12.0			33	2.50	140
CTX32T-150-R	15.0			30	2.80	130
CTX32T-180-R	18.0			27	3.30	120
CTX32T-220-R	22.0			25	3.70	110
CTX32T-270-R	27.0			20	5.00	80
CTX32T-330-R	33.0			17	5.60	70
CTX32T-390-R	39.0			16	6.40	65
CTX32T-470-R	47.0			15	7.00	60
CTX32T-560-R	56.0			13	8.00	55
CTX32T-680-R	68.0			12	9.00	50
CTX32T-820-R	82.0			11	10.00	45
CTX32T-101-R	100.0	20	0.796	10	10.00	40
CTX32T-121-R	120.0			10	11.00	70
CTX32T-151-R	150.0			8	15.00	65
CTX32T-181-R	180.0			7	17.00	60
CTX32T-221-R	220.0			7	21.00	50
CTX32T-271-R	270.0			6	28.00	45
CTX32T-331-R	330.0			5	34.00	40
CTX32T-391-R	390.0			5	42.00	35
CTX32T-471-R	470.0			4	40.00	25

Current ratings are achieved by reducing initial inductance values 10%

DC BIAS CHARACTERISTICS

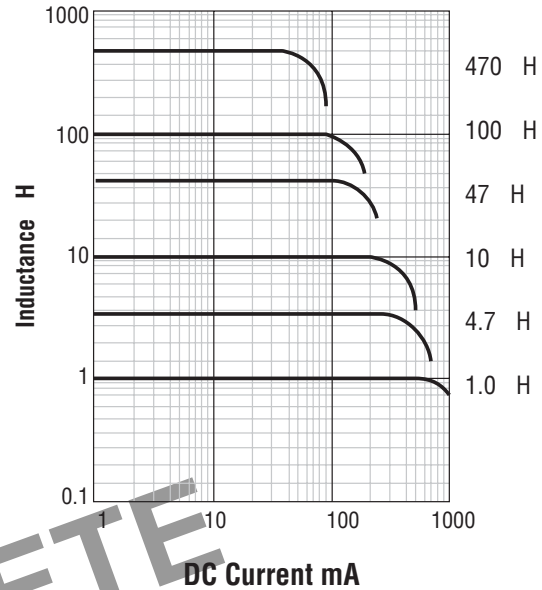

INDUCTANCE VS. FREQUENCY

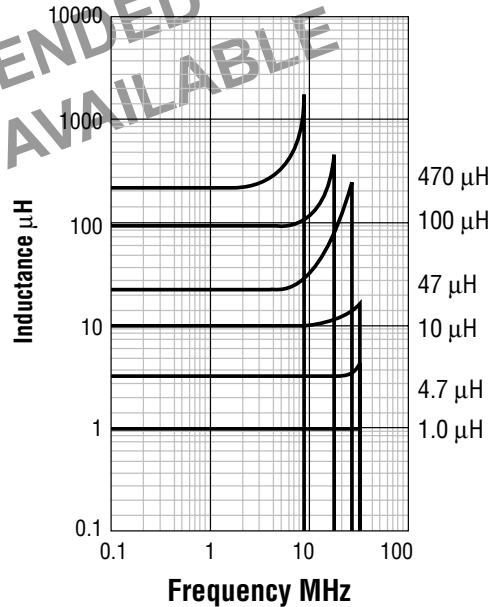

TEMPERATURE CHARACTERISTICS

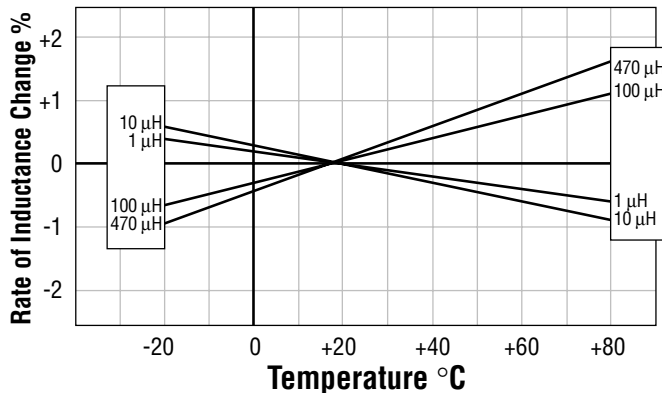

Q VS. FREQUENCY CHARACTERISTICS

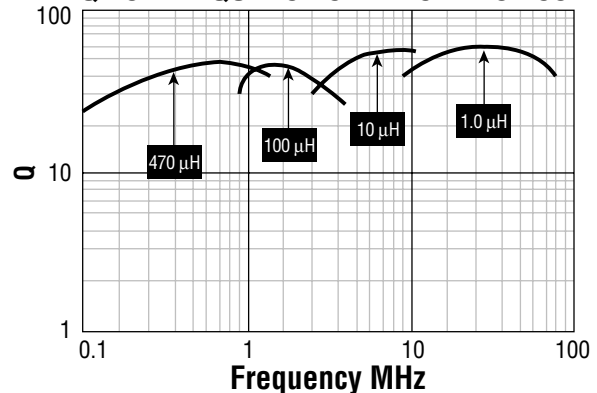

CTX32C Product Family

Coiltronics CTX32C Product Family Chip Inductors are ideally suited for moderate power circuit applications. They deliver twice the DC current carrying capability with less than half the DC resistance as the CTX32 Series.

Coiltronics Part Number	Inductance $\mu\text{H}/\text{TOL}$	Q Min	Test MHz	SRF Min.MHz	R_{DC} Max.Ohms	I_{DC} Rated mA
CTX32CT-1R0-R	10.0+/-20%	10	7.96	100	.15	850
CTX32CT-1R5-R	1.5			80	.18	700
CTX32CT-2R2-R	2.2			68	.23	600
CTX32CT-3R3-R	3.3			54	.28	500
CTX32CT-4R7-R	4.7	15		46	.34	430
CTX32CT-6R8-R	6.8			38	.42	360
CTX32CT-100-R	10.0+/-10%		2.52	30	.50	300
CTX32CT-150-R	15.0			26	.74	250
CTX32CT-220-R	22.0			21	1.15	210
CTX32CT-330-R	33.0			17	1.65	170
CTX32CT-470-R	47.0			14	2.25	150
CTX32CT-680-R	68.0			12	3.70	120
CTX32CT-101-R	100.0		0.796	10	5.00	100
CTX32CT-151-R	150.0	20		8	8.00	85
CTX32CT-221-R	220.0			7	11.00	70
CTX32CT-331-R	330.0			6	16.00	60

Current ratings are achieved by reducing initial inductance values 10%

DC BIAS CHARACTERISTICS

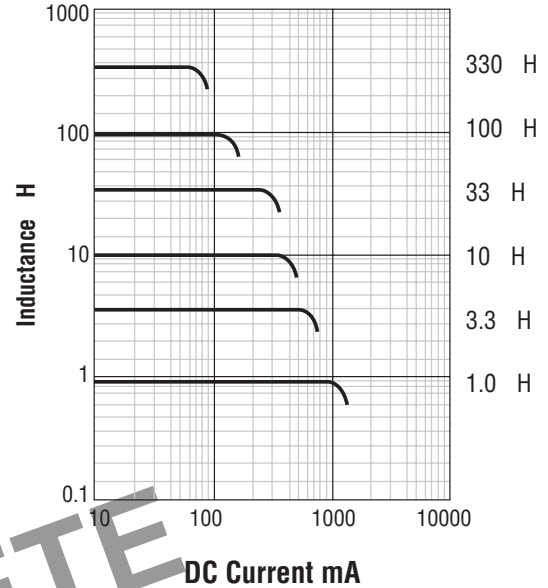

INDUCTANCE VS. FREQUENCY

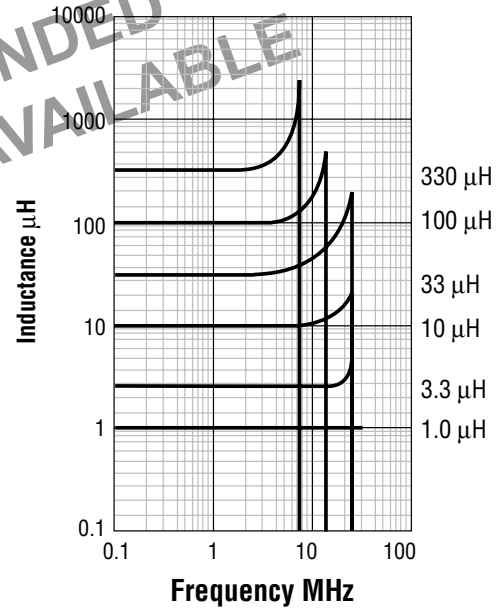

Q VS. FREQUENCY CHARACTERISTICS

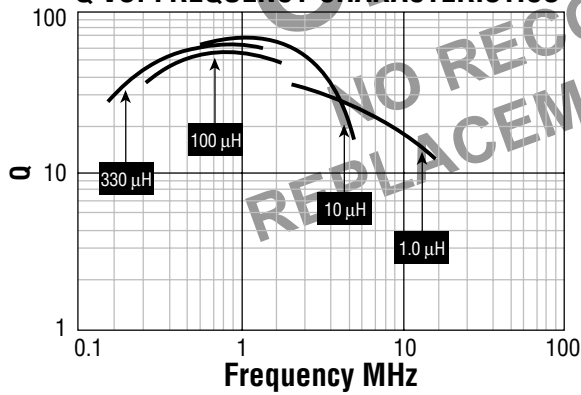

TEMPERATURE CHARACTERISTICS

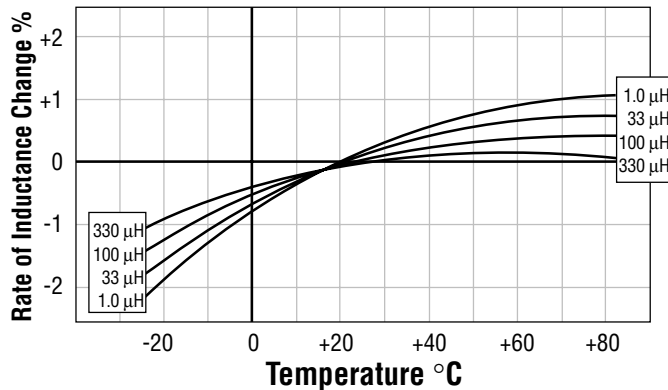

OBSOLETE
NO RECOMMENDED
REPLACEMENT AVAILABLE