



Chipsmall Limited consists of a professional team with an average of over 10 year of expertise in the distribution of electronic components. Based in Hongkong, we have already established firm and mutual-benefit business relationships with customers from,Europe,America and south Asia,supplying obsolete and hard-to-find components to meet their specific needs.

With the principle of "Quality Parts,Customers Priority,Honest Operation,and Considerate Service",our business mainly focus on the distribution of electronic components. Line cards we deal with include Microchip,ALPS,ROHM,Xilinx,Pulse,ON,Everlight and Freescale. Main products comprise IC,Modules,Potentiometer,IC Socket,Relay,Connector.Our parts cover such applications as commercial,industrial, and automotives areas.

We are looking forward to setting up business relationship with you and hope to provide you with the best service and solution. Let us make a better world for our industry!



Contact us

Tel: +86-755-8981 8866 Fax: +86-755-8427 6832

Email & Skype: info@chipsmall.com Web: www.chipsmall.com

Address: A1208, Overseas Decoration Building, #122 Zhenhua RD., Futian, Shenzhen, China



Cat. No. W195-E1-5

**SYSMAC CV-series
CV500/CV1000/CV2000/CVM1
Programmable Controllers**

INSTALLATION GUIDE

OMRON

Notice:

OMRON products are manufactured for use according to proper procedures by a qualified operator and only for the purposes described in this manual.

The following conventions are used to indicate and classify precautions in this manual. Always heed the information provided with them. Failure to heed precautions can result in injury to people or damage to property.

 **DANGER** Indicates an imminently hazardous situation which, if not avoided, will result in death or serious injury.

 **WARNING** Indicates a potentially hazardous situation which, if not avoided, could result in death or serious injury.

 **Caution** Indicates a potentially hazardous situation which, if not avoided, may result in minor or moderate injury, or property damage.

OMRON Product References

All OMRON products are capitalized in this manual. The word “Unit” is also capitalized when it refers to an OMRON product, regardless of whether or not it appears in the proper name of the product.

The abbreviation “Ch,” which appears in some displays and on some OMRON products, often means “word” and is abbreviated “Wd” in documentation in this sense.

The abbreviation “PC” means Programmable Controller and is not used as an abbreviation for anything else.

Visual Aids

The following headings appear in the left column of the manual to help you locate different types of information.

Note Indicates information of particular interest for efficient and convenient operation of the product.

1, 2, 3... 1. Indicates lists of one sort or another, such as procedures, checklists, etc.

© OMRON, 1992

All rights reserved. No part of this publication may be reproduced, stored in a retrieval system, or transmitted, in any form, or by any means, mechanical, electronic, photocopying, recording, or otherwise, without the prior written permission of OMRON.

No patent liability is assumed with respect to the use of the information contained herein. Moreover, because OMRON is constantly striving to improve its high-quality products, the information contained in this manual is subject to change without notice. Every precaution has been taken in the preparation of this manual. Nevertheless, OMRON assumes no responsibility for errors or omissions. Neither is any liability assumed for damages resulting from the use of the information contained in this publication.

TABLE OF CONTENTS

PRECAUTIONS	
1 Intended Audience	
2 General Precautions	
3 Safety Precautions	
4 Operating Environment Precautions	
5 Application Precautions	
6 Conformance to EC Directives	
SECTION 1	
Introduction	
1-1 Control Systems	
1-2 The Role of the PC	
1-3 PC Operation	
1-4 CV-series Manuals	
1-5 C-series–CV-series System Compatibility	
1-6 Networks and Remote I/O Systems	
1-7 New CPUs and Related Units	
1-8 CPU Comparison	
1-9 Improved Specifications	
SECTION 2	
System Configuration and Components	
2-1 System Configuration	
2-2 Racks	
2-3 Rack Components	
SECTION 3	
Installation	
3-1 Assembly	
3-2 Installation Environment	
3-3 Mounting Racks	
3-4 Power Supply Units	
3-5 Wiring I/O Units	
3-6 Compliance with EC Directives	
SECTION 4	
Inspection and Maintenance	
4-1 CPU Battery	
4-2 Memory Card Battery	
4-3 Output Unit Fuses	
4-4 Output Unit Relays	
SECTION 5	
Troubleshooting	
5-1 Error Messages and Alarm Outputs	
5-2 Troubleshooting Flowcharts	
5-3 Error Processing and Correction	
Appendices	
A Standard Models	
B Specifications	
Glossary	
Index	
Revision History	

About this Manual:

This manual describes the installation of the SYSMAC CV-series Programmable Controllers (CV500, CV1000, CV2000, and CVM1). This manual is designed to be used together with three CV-series PC operation manuals. The entire set of CV-series PC manuals is listed below. Only the basic portions of the catalog numbers are given; be sure you have the most recent version for your area.

Manual	Cat. No.
CV-series PC Installation Guide	W195
CV-series PC Operation Manual: SFC	W194
CV-series PC Operation Manual: Ladder Diagrams	W202
CV-series PC Operation Manual: Host Interface	W205

Programming and operating CV-series PCs are performed with the CV Support Software (CVSS), the SYSMAC Support Software (SSS), and the CV-series Programming Console for which the following manuals are available.

Product	Manuals
CVSS	The CV Series Getting Started Guidebook (W203) and the CV Support Software Operation Manuals: Basics (W196), Offline (W201), and Online (W200).
SSS	SYSMAC Support Software Operation Manuals: Basics (W247), C-series PC Operations (W248), and CVM1 Operations (W249)
CV-series Programming Console	CVM1-PRS21-E Programming Console Operation Manual (W222)

Note The CVSS does not support new instructions added for version-2 CVM1 PCs. The SSS does not support SFC programming (CV500, CV1000, or CV2000).

Section 1 introduces programmable controllers in general and provides tables of the Units that can be used with CV-series PCs and operation manuals available for CV-series products. Special products used to create networks, enable remote I/O, or provide additional programming capabilities are also provided. Tables are also provided of new products included for the first time in this version of the manual, along with a comparison of CPU capabilities, and a list of improvements made in recent CPU versions.

Section 2 describes the overall configuration that the PC System can take and introduces the main Units used in the system configuration.

Section 3 provides procedures on installing and wiring.

Section 4 provides information on ongoing maintenance.

Section 5 describes general troubleshooting and provides troubleshooting flowcharts.

Appendix A provides tables of C- and CV-series products that can be used with CV-series PCs.

Appendix B provides general PC specifications, dimensions, and I/O Unit specifications (including internal circuit configurations and wiring diagrams).

 **WARNING** Failure to read and understand the information provided in this manual may result in personal injury or death, damage to the product, or product failure. Please read each section in its entirety and be sure you understand the information provided in the section and related sections before attempting any of the procedures or operations given.

PRECAUTIONS

This section provides general precautions for using the Programmable Controller (PC) and related devices.

The information contained in this section is important for the safe and reliable application of the Programmable Controller. You must read this section and understand the information contained before attempting to set up or operate a PC system.

- 1 Intended Audience
- 2 General Precautions
- 3 Safety Precautions
- 4 Operating Environment Precautions
- 5 Application Precautions
- 6 Conformance to EC Directives

1 Intended Audience

This manual is intended for the following personnel, who must also have knowledge of electrical systems (an electrical engineer or the equivalent).

- Personnel in charge of installing FA systems.
- Personnel in charge of designing FA systems.
- Personnel in charge of managing FA systems and facilities.

2 General Precautions

The user must operate the product according to the performance specifications described in the operation manuals.

Before using the product under conditions which are not described in the manual or applying the product to nuclear control systems, railroad systems, aviation systems, vehicles, combustion systems, medical equipment, amusement machines, safety equipment, and other systems, machines, and equipment that may have a serious influence on lives and property if used improperly, consult your OMRON representative.

Make sure that the ratings and performance characteristics of the product are sufficient for the systems, machines, and equipment, and be sure to provide the systems, machines, and equipment with double safety mechanisms.

This manual provides information for programming and operating the Unit. Be sure to read this manual before attempting to use the Unit and keep this manual close at hand for reference during operation.

 **WARNING** It is extremely important that a PC and all PC Units be used for the specified purpose and under the specified conditions, especially in applications that can directly or indirectly affect human life. You must consult with your OMRON representative before applying a PC System to the above-mentioned applications.

3 Safety Precautions

 **WARNING** Do not attempt to take any Unit apart while the power is being supplied. Doing so may result in electric shock.

 **WARNING** Do not touch any of the terminals or terminal blocks while the power is being supplied. Doing so may result in electric shock.

 **WARNING** Do not attempt to disassemble, repair, or modify any Units. Any attempt to do so may result in malfunction, fire, or electric shock.

 **WARNING** There is a lithium battery built into the SRAM Memory Cards. Do not short the positive and negative terminals of the battery, charge the battery, attempt to take it apart, subject it to pressures that would deform it, incinerate it, or otherwise mistreat it. Doing any of these could cause the battery to erupt, ignite, or leak.

 **Caution** Tighten the screws on the terminal block of the AC Power Supply Unit to the torque specified in the operation manual. The loose screws may result in burning or malfunction.

4 Operating Environment Precautions

 **Caution** Do not operate the control system in the following places:

- Locations subject to direct sunlight.
- Locations subject to temperatures or humidity outside the range specified in the specifications.
- Locations subject to condensation as the result of severe changes in temperature.
- Locations subject to corrosive or flammable gases.
- Locations subject to dust (especially iron dust) or salts.
- Locations subject to exposure to water, oil, or chemicals.
- Locations subject to shock or vibration.

 **Caution** Take appropriate and sufficient countermeasures when installing systems in the following locations:

- Locations subject to static electricity or other forms of noise.
- Locations subject to strong electromagnetic fields.
- Locations subject to possible exposure to radioactivity.
- Locations close to power supplies.

 **Caution** The operating environment of the PC System can have a large effect on the longevity and reliability of the system. Improper operating environments can lead to malfunction, failure, and other unforeseeable problems with the PC System. Be sure that the operating environment is within the specified conditions at installation and remains within the specified conditions during the life of the system.

5 Application Precautions

Observe the following precautions when using the PC System.

 **WARNING** Always heed these precautions. Failure to abide by the following precautions could lead to serious or possibly fatal injury.

- Always ground the system to 100 Ω or less when installing the Units. Not connecting to a ground of 100 Ω or less may result in electric shock.
- Always turn OFF the power supply to the PC before attempting any of the following. Not turning OFF the power supply may result in malfunction or electric shock.
 - Mounting or dismounting I/O Units, Memory Cassettes, or any other Units.
 - Setting switches.
 - Connecting cables or wiring the system.
 - Connecting or disconnecting the connectors.

 **Caution** Failure to abide by the following precautions could lead to faulty operation of the PC or the system, or could damage the PC or PC Units. Always heed these precautions.

- Fail-safe measures must be taken by the customer to ensure safety in the event of incorrect, missing, or abnormal signals caused by broken signal lines, momentary power interruptions, or other causes.

- Interlock circuits, limit circuits, and similar safety measures in external circuits (i.e., not in the Programmable Controller) must be provided by the customer.
- Always use the power supply voltage specified in the operation manuals. An incorrect voltage may result in malfunction or burning.
- Take appropriate measures to ensure that the specified power with the rated voltage and frequency is supplied. Be particularly careful in places where the power supply is unstable. An incorrect power supply may result in malfunction.
- Install external breakers and take other safety measures against short-circuiting in external wiring. Insufficient safety measures against short-circuiting may result in burning.
- Do not apply voltages to the Input Units in excess of the rated input voltage. Excess voltages may result in burning.
- Do not apply voltages or connect loads to the Output Units in excess of the maximum switching capacity. Excess voltages or loads may result in burning.
- Disconnect the functional ground terminal when performing withstand voltage tests. Not disconnecting the functional ground terminal may result in burning.
- Install the Unit properly as specified in the operation manual. Improper installation of the Unit may result in malfunction.
- Be sure that all the mounting screws, terminal screws, and cable connector screws are tightened to the torque specified in the relevant manuals. Incorrect tightening torque may result in malfunction.
- Use crimp terminals for wiring. Do not connect bare stranded wires directly to terminals. Connection of bare stranded wires may result in burning.
- Double-check all the wiring before turning on the power supply. Incorrect wiring may result in burning.
- Be sure that the terminal blocks, Memory Units, expansion cables, and other items with locking devices are properly locked into place. Improper locking may result in malfunction.
- Check the user program for proper execution before actually running it on the Unit. Not checking the program may result in an unexpected operation.
- Confirm that no adverse effect will occur in the system before attempting any of the following. Not doing so may result in an unexpected operation.
 - Changing the operating mode of the PC.
 - Force-setting/force-resetting any bit in memory.
 - Changing the present value of any word or any set value in memory.
- Resume operation only after transferring to the new CPU Unit the contents of the DM Area, HR Area, and other data required for resuming operation. Not doing so may result in an unexpected operation.
- Do not pull on the cables or bend the cables beyond their natural limit. Doing either of these may break the cables.
- Do not place objects on top of the cables. Doing so may break the cables.

6 Conformance to EC Directives

The CV-series PCs that comply with EC Directives must be installed as follows:

- 1, 2, 3... 1. The CV-series PCs are designed for installation inside control panels. The PC must be installed within a control panel.
2. Use reinforced insulation or double insulation for the DC power supplies to be connected to the DC I/O Units for CV500-PS211. Use separate power supplies as the external power supplies for the Relay Output Units and the power supplies for the DC I/O Units.
3. To meet the EC Directives (Low Voltage Directive), the maximum switching capacity while the CV500-PS211 is being operated is 24 VDC/2 A.

4. PCs complying with EC Directives also conform to the Common Emission Standard (EN50081-2). When a PC is built into a machine, however, noise can be generated by switching devices using relay outputs and cause the overall machine to fail to meet the Standards. If this occurs, surge killers must be connected or other measures taken external to the PC.

The following methods represent typical methods for reducing noise, and may not be sufficient in all cases. Required countermeasures will vary depending on the devices connected to the control panel, wiring, the configuration of the system, and other conditions.

Countermeasures

Refer to EN50081-2 for more details.

Countermeasures are not required if the frequency of load switching for the whole system including the PC is less than 5 times per minute.

Countermeasures are required if the frequency of load switching for the whole system including the PC is 5 or more times per minute.

Countermeasure Examples

When switching an inductive load, connect a surge protector, diodes, etc., in parallel with the load or contact as shown below.

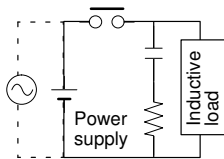
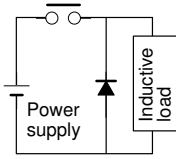
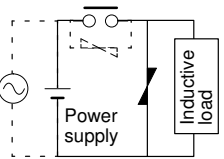
Circuit	Current		Characteristic	Required element
	AC	DC		
<p>CR method</p> 	Yes	Yes	<p>If the load is a relay or solenoid, there is a time lag between the moment the circuit is opened and the moment the load is reset.</p> <p>If the supply voltage is 24 or 48 V, insert the surge protector in parallel with the load. If the supply voltage is 100 to 200 V, insert the surge protector between the contacts.</p>	<p>The capacitance of the capacitor must be 1 to 0.5 μF per contact current of 1 A and resistance of the resistor must be 0.5 to 1 Ω per contact voltage of 1 V. These values, however, vary with the load and the characteristics of the relay. Decide these values from testing, and take into consideration that the capacitance suppresses spark discharge when the contacts are separated and the resistance limits the current that flows into the load when the circuit is closed again.</p> <p>The dielectric strength of the capacitor must be 200 to 300 V. If the circuit is an AC circuit, use a capacitor with no polarity.</p>
<p>Diode method</p> 	No	Yes	<p>The diode connected in parallel with the load changes energy accumulated by the coil into a current, which then flows into the coil so that the current will be converted into Joule heat by the resistance of the inductive load.</p> <p>This time lag, between the moment the circuit is opened and the moment the load is reset, caused by this method is longer than that caused by the CR method.</p>	<p>The reversed dielectric strength value of the diode must be at least 10 times as large as the circuit voltage value. The forward current of the diode must be the same as or larger than the load current.</p> <p>The reversed dielectric strength value of the diode may be two to three times larger than the supply voltage if the surge protector is applied to electronic circuits with low circuit voltages.</p>
<p>Varistor method</p> 	Yes	Yes	<p>The varistor method prevents the imposition of high voltage between the contacts by using the constant voltage characteristic of the varistor. There is time lag between the moment the circuit is opened and the moment the load is reset.</p> <p>If the supply voltage is 24 or 48 V, insert the varistor in parallel with the load. If the supply voltage is 100 to 200 V, insert the varistor between the contacts.</p>	---

When switching a load with a high inrush current such as an incandescent lamp, suppress the inrush current as shown below.

Countermeasure 1

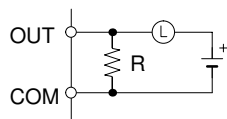

Providing a dark current of approx. one-third of the rated value through an incandescent lamp

Countermeasure 2

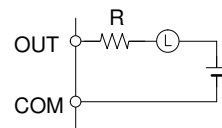

Providing a limiting resistor

SECTION 1

Introduction

This section provides general information about Programmable Controllers and how they fit into a Control System. It also lists the C-series products that can be used with the CV-series PCs and operation manuals available for CV-series products. Finally, this section introduces Systems that can be used to create networks and enable remote I/O.

- 1-1 Control Systems
- 1-2 The Role of the PC
- 1-2-1 Input Devices
- 1-2-2 Output Devices
- 1-3 PC Operation
- 1-4 CV-series Manuals
- 1-5 C-series–CV-series System Compatibility
- 1-6 Networks and Remote I/O Systems
- 1-7 New CPUs and Related Units
- 1-8 CPU Comparison
- 1-9 Improved Specifications
- 1-9-1 Upgraded Specifications
- 1-9-2 Version-1 CPUs
- 1-9-3 Version-2 CVM1 PCs

1-1 Control Systems

A Control System is the electronic equipment needed to control a particular process. It may include everything from a process control computer, to the factory computer, down through the PCs, and then on down through the network to the I/O devices: control components like the switches, stepping motors, solenoids, and sensors which monitor and control mechanical operations.

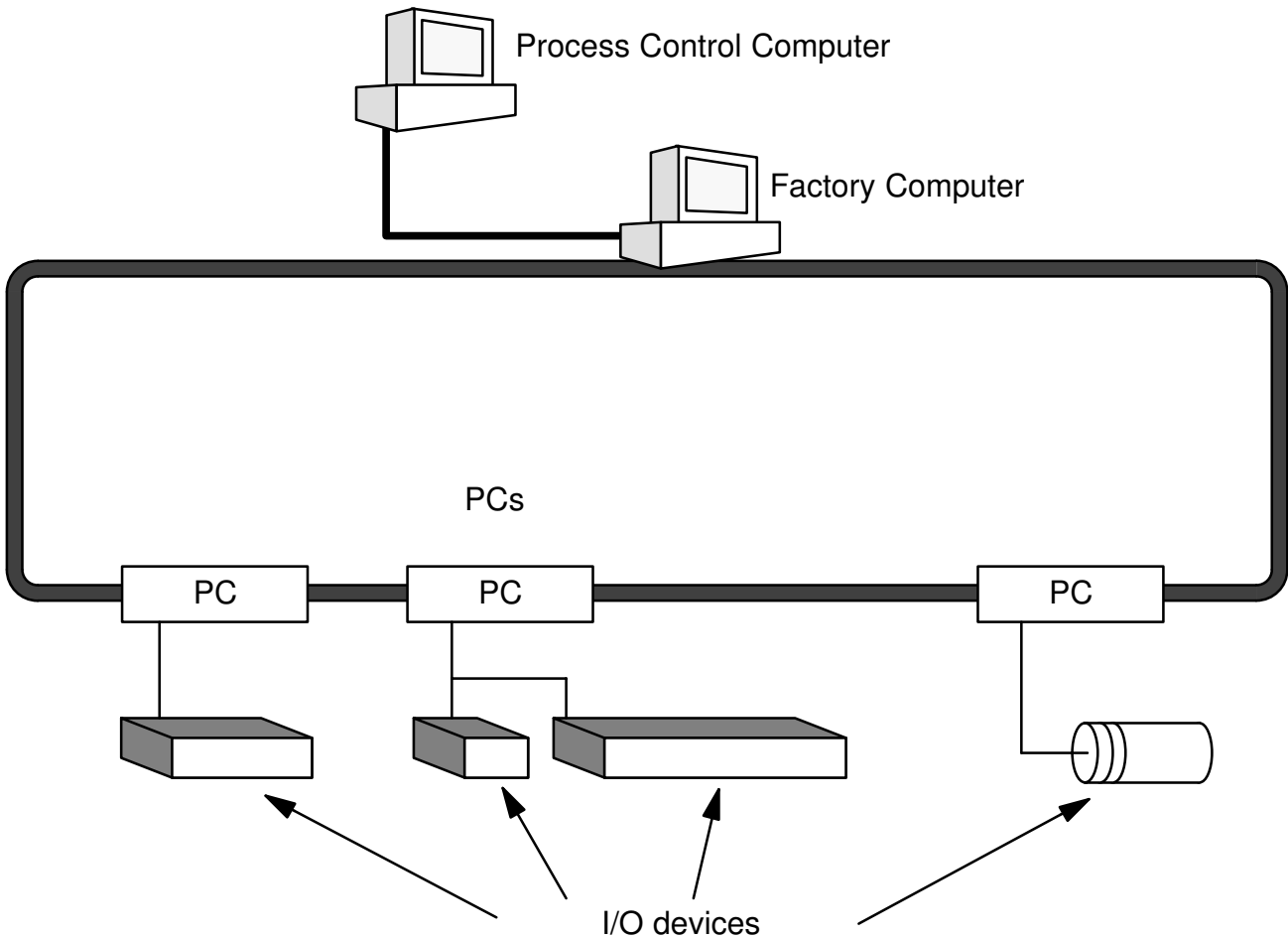

A Control System can involve very large applications where many different models of PC are networked together or it could be an application as small as a single PC controlling a number of output devices.

1-2 The Role of the PC

The PC is the part of the Control System that directly controls the manufacturing process. According to the program stored in its memory, the PC accepts data from the input devices connected to it and uses this data to monitor the controlled system. When the program calls for some action to take place, the PC sends data to the output devices connected to it to cause that action to take place. The PC may be used to control a simple, repetitive task, or it may be connected to other PCs or to a host computer in order to integrate the control of a complex process.

1-2-1 Input Devices

PCs can receive inputs from either automated or manual devices. The PC could receive data from the user via a pushbutton switch, keyboard, or similar device. Automated inputs could come from a variety of devices: micro-switches, timers, encoders, photoelectric sensors, and so on. Some devices, like the limit switch shown below, turn ON or OFF when the equipment actually makes contact with them. Other devices, like the photoelectric sensor and proximity sensor shown below, use other means, such as light or inductance, in order to get information about the equipment being monitored.

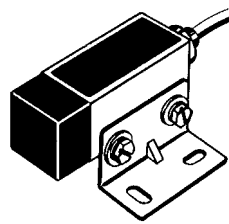

Photoelectric Sensor

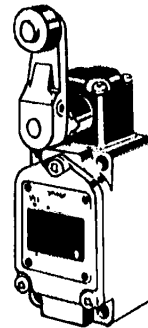

Limit Switch

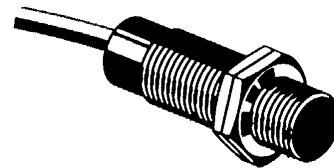

Proximity Sensor

1-2-2 Output Devices

A PC can output to a myriad of devices for use in automated control. Almost anything that you can think of could be controlled by a PC. Some of the most common devices are motors, solenoids, servomotors, stepping motors, valves, switches, indicator lights, buzzers, and alarms. Some of these output devices, such as the motors, solenoids, servomotors, stepping motors, and valves, affect the controlled system directly. Others, such as the indicator lights, buzzers, and alarms, provide outputs to notify personnel operating or monitoring the system.

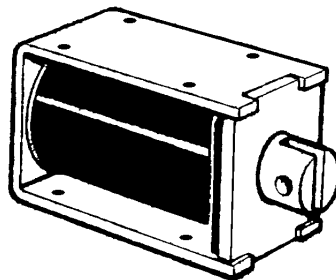

Solenoid

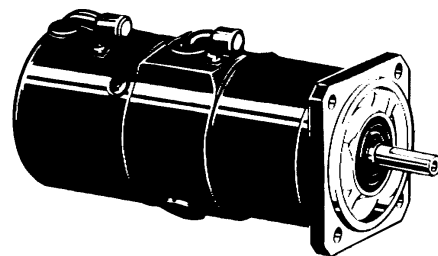

Servomotor

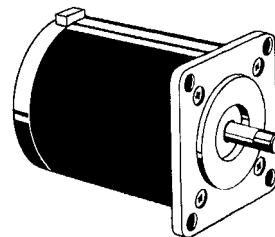

Stepping Motor

1-3 PC Operation

PCs operate by monitoring input signals and providing output signals. When changes are detected in input signals, the PC reacts through the user-programmed internal logic to produce output signals. The PC continually executes the program in its memory to achieve this control.

Block Diagram of PC

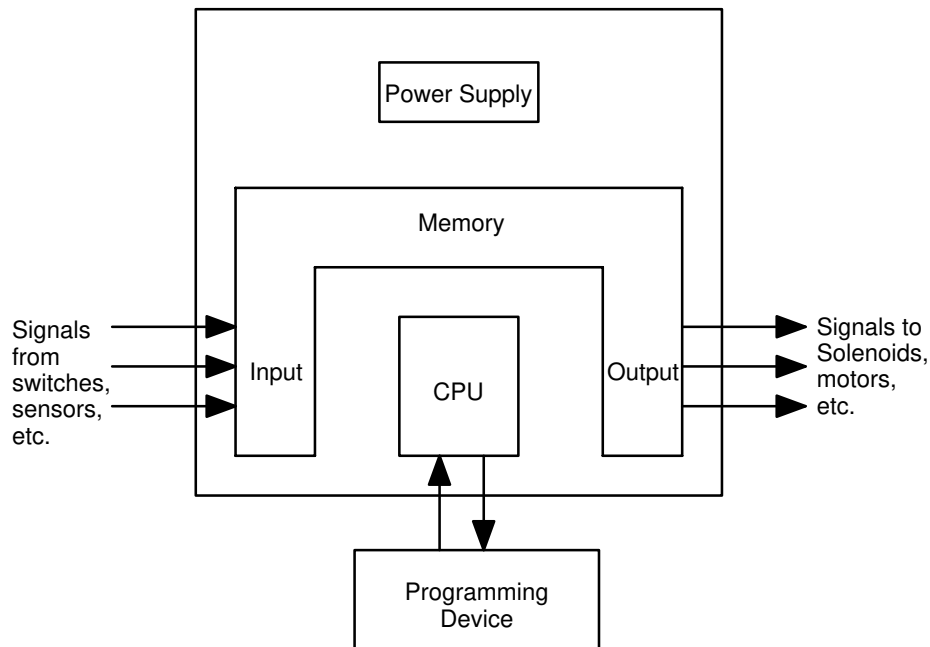

A program for your applications must be designed and stored in the PC. This program is then executed as part of the cycle of internal operations of the PC.

Execution Cycle

When a PC operates, i.e., when it executes its program to control an external system, a series of operations are performed inside the PC. These internal operations can be broadly classified into the following four categories. Refer to the *CV-series PCs Operation Manual: Ladder Diagrams* for details.

- 1, 2, 3...**
1. Common (or overseeing) processes, such as watchdog timer operation and testing the program memory.
 2. Data input and output.
 3. Program execution.
 4. Peripheral device servicing.

Cycle Time

The total time required for a PC to perform all these internal operations is called the cycle time.

Timing is one of the most important factors in designing a Control System. For accurate operations, it is necessary to have answers to such questions as these:

- How long does it take for the PC to execute all the instructions in its memory?
- How long does it take for the PC to produce a control output in response to a given input signal?

The cycle time of the PC can be automatically calculated and monitored, but it is necessary to have an understanding of the timing relationships within the PC for effective System design and programming. Refer to the *CV-series PCs Operation Manual: Ladder Diagrams* for details on internal PC processing and to the *CVSS Operation Manuals* for details on monitoring the cycle time.

1-4 CV-series Manuals

The following manuals are available for the various CV-series products. Other manuals are also available for compatible C-series products (see next section). Catalog number suffixes have been omitted; be sure you have the most recent version for your region.

Product	Manual	Cat. No.
CV-series PCs	CV-series PCs Installation Guide	W195
	CV-series PCs Operation Manual: SFC	W194
	CV-series PCs Operation Manual: Ladder Diagrams	W202
	CV-series PCs Operation Manual: Host Link System, CV500-LK201 Host Link Unit	W205
CV Support Software (CVSS)	The CV Series Getting Started Guidebook	W203
	CV Support Software Operation Manual: Basics	W196
	CV Support Software Operation Manual: Offline	W201
	CV Support Software Operation Manual: Online	W200
SYSMAC Support Software (SSS)	SYSMAC Support Software Operation Manual: Basics	W247
	SYSMAC Support Software Operation Manual: CVM1 PCs	W249
Graphic Programming Console (GPC)	CV500-MP311-E Graphic Programming Console Operation Manual	W216
Programming Console	CVM1-PRS21-E Programming Console Operation Manual	W222
SYSMAC NET Link System	SYSMAC NET Link System Manual	W213
SYSMAC LINK System	SYSMAC LINK System Manual	W212
SYSMAC BUS/2 Remote I/O System	SYSMAC BUS/2 Remote I/O System Manual	W204
CompoBus/D (DeviceNet)	CompoBus/D (DeviceNet) Operation Manual	W267
CV-series Ethernet Unit	CV-series Ethernet System Manual	W242
BASIC Unit	BASIC Unit Reference Manual	W207
	BASIC Unit Operation Manual	W206
Personal Computer Unit	Personal Computer Unit Operation Manual	W251
	Personal Computer Unit Technical Manual	W252
Motion Control Unit	Motion Control Unit Operation Manual: Introduction	W254
	Motion Control Unit Operation Manual: Details	W255
Temperature Controller Data Link Unit	CV500-TDL21 Temperature Controller Data Link Unit	W244
Memory Card Writer	CV500-MCW01-E Memory Card Writer Operation Manual	W214
Optical Fiber Cable	Optical Fiber Cable Installation Guide	W156

1-5 C-series–CV-series System Compatibility

The following table shows when C-series Units can be used and when CV-series Units must be used. Any C-series Unit or Peripheral Device not listed in this table cannot be used with the CV-series PCs.

Unit		C Series	CV Series	Remarks
CPU Rack	CPU	No	Yes	CV500-CPU01-EV1, CV1000-CPU01-EV1, CV2000-CPU01-EV1, CVM1-CPU01-EV2, CVM1-CPU11-EV2, and CVM1-CPU21-EV2
	Power Supply	No	Yes	CV500-PS221, CV500-PS211, and CVM1-PA208
	CPU Backplane	No	Yes	CV500-BC031, CV500-BC051, CV500-BC101, CVM1-BC103, and CVM1-BC053
	I/O Control Unit	No	Yes	CV500-IC□01
Expansion CPU Backplane		No	Yes	CV500-BI111
Expansion I/O Backplane		No	Yes	CV500-BI042, CV500-BI062, CV500-BI112, CVM1-BI114, and CVM1-BI064 (C500 Expansion I/O Racks can be used with certain limitations.)
16-/32-/64-point I/O Units		Yes	Yes	---
Special I/O Units		Yes	Yes	Applicable Units include Analog Input, Analog Output, High-speed Counter, PID, Position Control, Magnetic Card, ASCII, ID Sensor, and Ladder Program I/O Units (The C500-ASC03 cannot be used.)
BASIC Unit		No	Yes	CV500-BSC□1
Personal Computer Unit		No	Yes	CV500-VP213-E/217-E/223-E/227-E
Temperature Control Data Link Unit		No	Yes	CV500-TDL21
Link Systems	SYSMAC NET	No	Yes	CV500-SNT31
	SYSMAC LINK	No	Yes	CV500-SLK11 and CV500-SLK21
	Host Link Unit	No	Yes	CV500-LK201
	Ethernet Unit	No	Yes	CV500-ETN01
Remote I/O Systems	SYSMAC BUS Units	Yes	Yes	---
	SYSMAC BUS/2	No	Yes	CV500-RM211/221 and CV500-RT211/221
Peripheral Devices	CV Support Software	No	Yes (See note.)	CV500-ZS3AT1-EV2 (3 1/2" floppy disks) and CV500-ZS5AT1-EV2 (5 1/4" floppy disks) for IBM PC/AT compatible
	SYSMAC Support Software (SSS)	Yes	Yes (See note.)	C500-ZL3AT1-E (3.5" floppy disks) for IBM PC/AT compatible
	Graphic Programming Console	Yes (Main unit only)	Yes (System Cassette) (See note.)	GPC: 3G2C5-GPC03-E System Cassette: CV500-MP311-E
	Programming Console	No	Yes (See note.)	CVM1-PRS21-EV1 (set)

Note The CVSS does not support new instructions added for version-2 CVM1 PCs. The SSS does not support SFC programming (CV500, CV1000, and CV2000). New instructions added for version-2 CVM1 PCs are also supported by version-1 CV-series Programming Consoles.

1-6 Networks and Remote I/O Systems

Systems that can be used to create networks and enable remote I/O are introduced in this section. Refer to the operation manuals for the Systems for details.

SYSMAC NET Link System

The SYSMAC NET Link System is a LAN (local area network) for use in factory automation systems. The SYSMAC NET Link System can consist of up to 128 nodes among which communications may be accomplished via datagrams, data transfers, or automatic data links.

Datagrams transmit and receive data using a command/response format. Commands can be issued from the user program by the DELIVER COMMAND instruction (CMND(194)).

Data can also be transmitted and received using the NETWORK SEND and NETWORK RECEIVE (SEND(192)/RCV(193)) instructions in the user program. Up to 256 words of data can be transferred for each instruction.

Automatic data links allow PCs and computers to create common data areas.

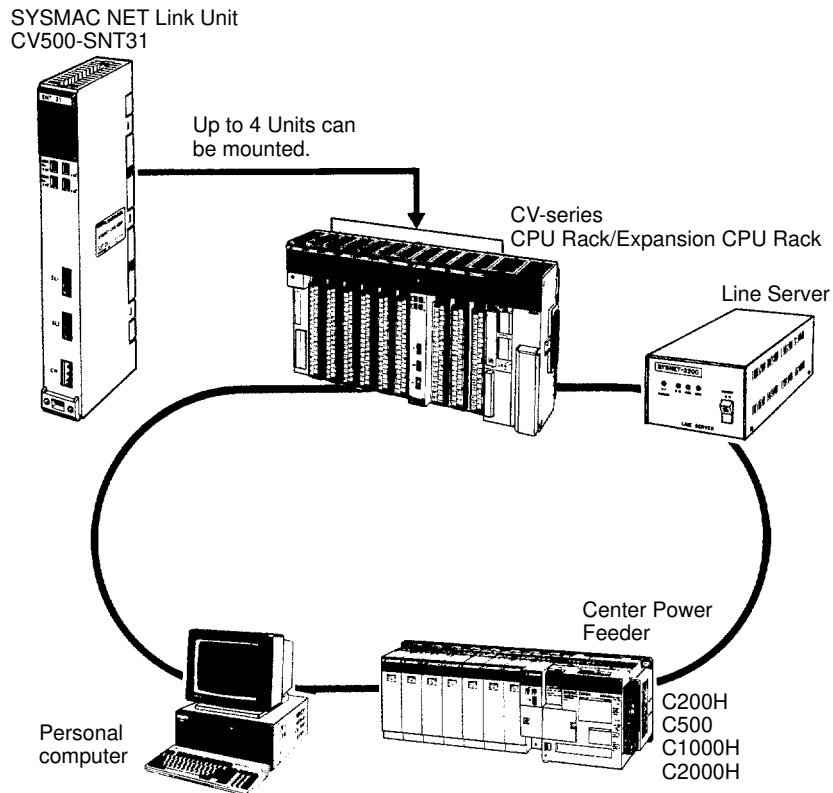

Note Up to four SYSMAC NET Link Units (CV500-SNT31) can be mounted to the CPU Rack and/or Expansion CPU Rack of each CV-series PC.

SYSMAC LINK System

Networks can also be created using SYSMAC LINK Systems. A SYSMAC LINK System can consist of up to 62 PCs, including the CV500, CV1000, CV2000, CVM1, C200H, C1000H, and C2000H. Communications between the PCs is accomplished via datagrams, data transfers, or automatic data links in ways similar to the SYSMAC NET Link System.

The main differences between SYSMAC NET Link and SYSMAC LINK Systems is in the structure of automatic data links and in the system configuration, e.g., only PCs can be linked in SYSMAC LINK Systems, whereas other devices can form nodes in SYSMAC NET Link Systems.

Datagrams transmit and receive data using a command/response format. Commands can be issued from the user program by the DELIVER COMMAND instruction (CMND(194)).

Data can also be transmitted and received using the NETWORK SEND and NETWORK RECEIVE (SEND(192)/RCV(193)) instructions in the user program. Up to 256 words of data can be transferred for each instruction.

Automatic data links allow PCs and computers to create common data areas.

SYSMAC LINK Unit
 CV500-SLK11 (optical)
 CV500-SLK21 (wired)

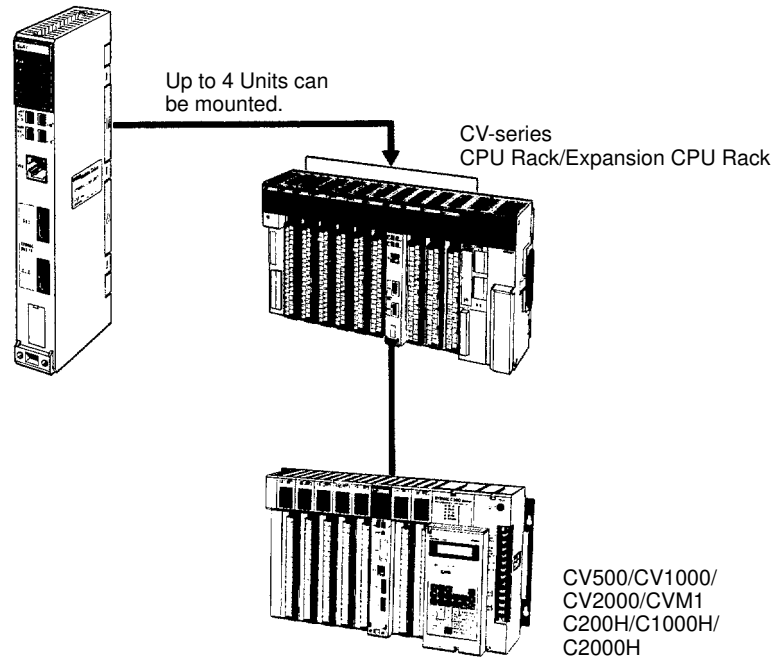

Note Up to four SYSMAC LINK Units (CV500-SLK11/21) can be mounted the CPU Rack and/or Expansion CPU Rack of each CV-series PC.

SYSMAC BUS/2 Remote I/O System

Remote I/O can be enabled by adding a SYSMAC BUS/2 Remote I/O System to the PC. The SYSMAC BUS/2 Remote I/O System is available in two types: optical and wired.

Two Remote I/O Master Units, optical or wired, can be mounted to the CV500 or CVM1-CPU01-EV2 CPU Rack or Expansion CPU Rack. Four Remote I/O Master Units can be mounted to the CV1000, CV2000, or CVM1-CPU11/21-EV2 CPU Rack or Expansion CPU Rack.

Up to eight Remote I/O Slave Racks can be connected per PC.

Slaves can be used to provide up to 1,024 remote I/O points for the CV500 or CVM1-CPU01-EV2; up to 2,048 remote I/O points for the CV1000, CV2000, or CVM1-CPU11/21-EV2. These limits are the totals for all Slaves control by one PC.

A Programming Device (such as the CVSS) can be connected to up to two Remote I/O Slave Units for each Remote I/O Master Unit as long as a total of no more than four Programming Devices are connected per PC.

Remote I/O Master Unit
CV500-RM211 (optical)
CV500-RM221 (wired)

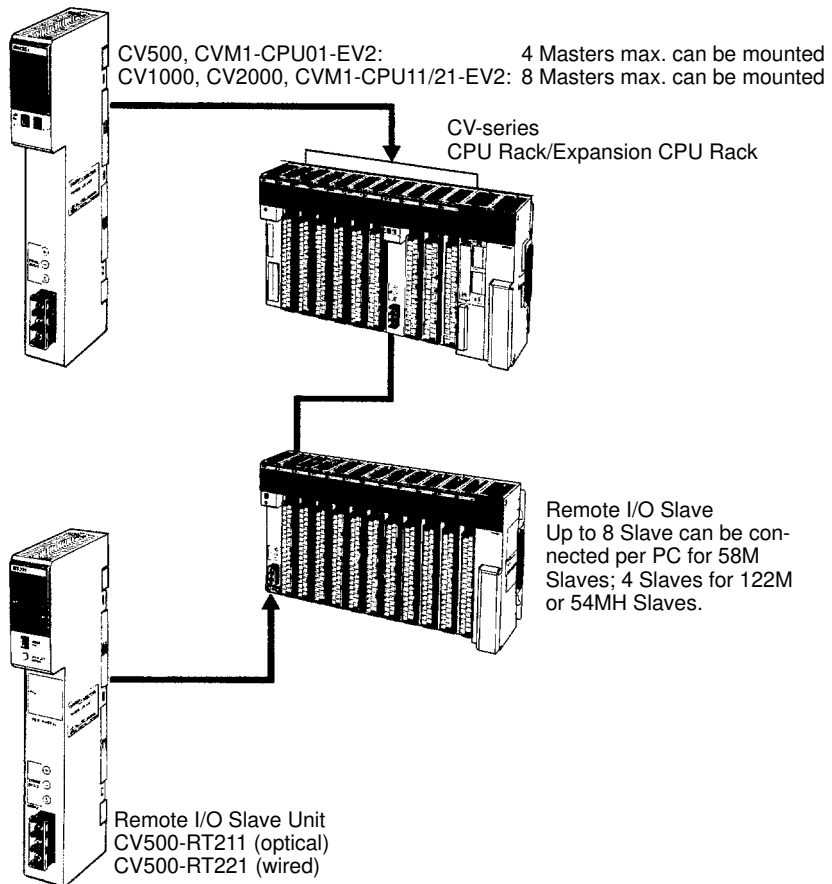

SYSMAC BUS Remote I/O System

Remote I/O can also be enabled by using the C-series SYSMAC BUS Remote I/O System with CV-series PC.

Remote I/O Master Units can be mounted on any slot of the CPU Rack, Expansion CPU Rack, or Expansion I/O Rack. Up to four Masters can be mounted for the CV500 or CVM1-CPU01-EV2, up to eight Masters for the CV1000, CV2000, or CVM1-CPU11/21-EV2.

For each Master, up to two Slave Racks can be connected for the CV500 or CVM1-CPU01-EV2; up to eight Slave Racks for the CV1000, CV2000, or CVM1-CPU11/21-EV2. No more than 16 Slave Racks can be connected per PC.

Slaves can be used to provide up to 512 remote I/O points for the CV500 or CVM1-CPU01-EV2; up to 1,024 remote I/O points for the CV1000, CV2000, or CVM1-CPU11-EV2; up to 2,048 remote I/O points for the CVM1-CPU21-EV2. These limits are the totals for all Slaves control by one PC.

Programming Devices cannot be connected to SYSMAC BUS Slave Racks.

Remote I/O Master Unit
 3G2A5-RM001-(P)EV1 (optical)
 C500-RM201 (wired)

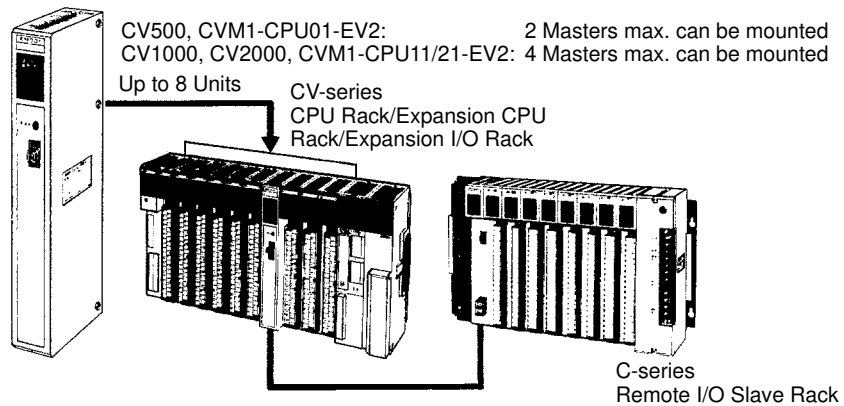

Host Link System (SYSMAC WAY)

The CV-series PCs can be connected to a host computer with the host link connector via the CPU or a CV500-LK201 Host Link Unit mounted to a Rack.

RS-232C or RS-422 communications can be used depending on the switch setting. When RS-422 is selected, up to 32 PCs can be connected to a single host.

Data is transmitted and received by commands and responses.

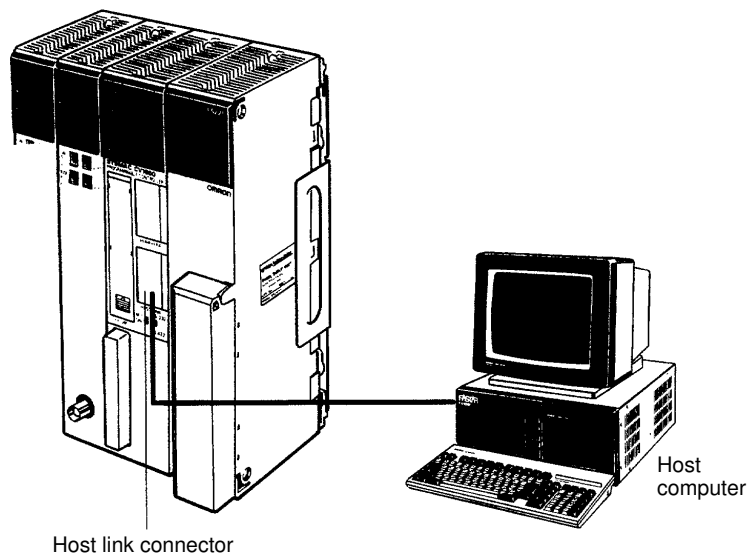

BASIC Unit

The BASIC Unit can be connected to a personal computer to enable communications with the PC using the BASIC programming language. Up to 512 bytes (256 words) of data can be transferred between the BASIC Unit and the CPU by the PC READ/WRITE command without using the PC program.

Up to 256 words of data can also be transferred between the BASIC Unit and the PC's CPU by using the NETWORK SEND and NETWORK RECEIVE (SEND(192)/RECV(193)) instructions in the PC program.

Data can also be transferred to other BASIC Units mounted on the same PC, or to BASIC Units mounted to other PCs connected by networks formed using a SYSMAC NET Link or SYSMAC LINK System. RS-232C, RS-422, Centronics, and GPIB interfaces are available.

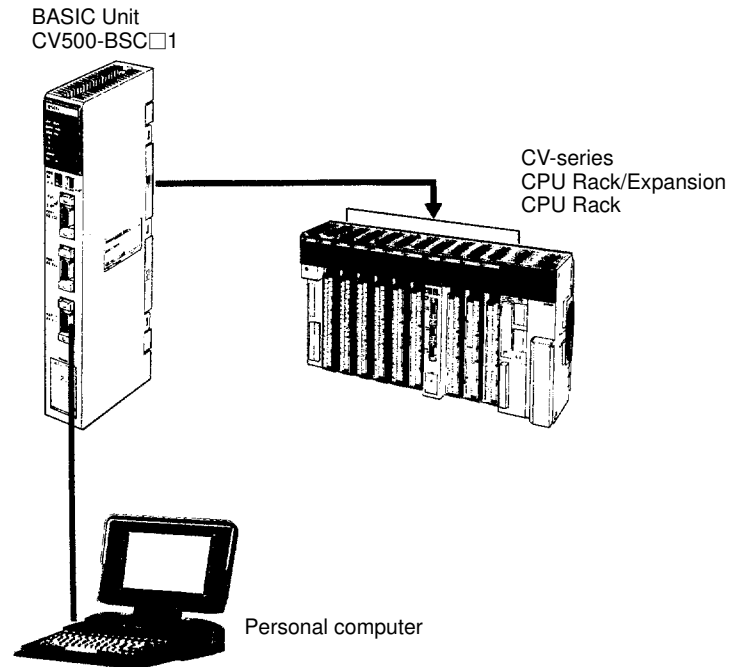

Personal Computer Unit

The Personal Computer Unit is a full-fledged IBM PC/AT compatible that can be used to run independent programming directly on a Rack to eliminate the need for separate installation space. It can run along or connected to any of the normal peripherals supported by IBM PC/AT compatibles (mice, keyboards, monitors, data storage devices, etc.), and as a CPU Bus Unit, the Personal Computer Unit interfaces directly to the PC's CPU through the CPU bus to eliminate the need for special interface hardware, protocols, or programming.

1-7 New CPUs and Related Units

The following new CV-series CPUs and related Units are included in this version of the manual for the first time. Refer to relevant sections of this manual or the *CV-series PC Operation Manual: Ladder Diagrams* for further details.

Unit	Model number	Main specifications
CPU	CVM1-CPU01-EV2	I/O capacity: 512 pts; Ladder diagrams only
	CVM1-CPU11-EV2	I/O capacity: 1,024 pts; Ladder diagrams only
	CVM1-CPU21-EV2	I/O capacity: 2,048 pts; Ladder diagrams only
	CV500-CPU01-EV1	I/O capacity: 512 pts; Ladder diagrams or SFC + ladder diagrams
	CV1000-CPU01-EV1	I/O capacity: 1,024 pts; Ladder diagrams or SFC + ladder diagrams
	CV2000-CPU01-EV1	I/O capacity: 2,048 pts; Ladder diagrams or SFC + ladder diagrams
Temperature Controller Data Link Unit	CV500-TDL21	Connects up to 64 temperature control devices via 2 ports.

1-8 CPU Comparison

The following table shows differences between the various CV-series CPUs.

CPU		CVM1-CPU01-EV2	CVM1-CPU11-EV2	CVM1-CPU21-EV2	CV500-CPU01-EV1	CV1000-CPU01-EV1	CV2000-CPU01-EV1
Program- ming	Ladder diagrams	Supported	Supported	Supported	Supported	Supported	Supported
	SFC	Not supported	Not supported	Not supported	Supported	Supported	Supported
	Instructions	284	284	285	169	170	170
Speed	Basic instructions (ms)	0.15 to 0.45	0.125 to 0.375	0.125 to 0.375	0.15 to 0.45	0.125 to 0.375	0.125 to 0.375
	Other instructions (ms)	0.6 to 9.9	0.5 to 8.25	0.5 to 8.25	0.6 to 9.9	0.5 to 8.25	0.5 to 8.25
Program capacity (see note)		30K words	30K words	62K words	30K words	62K words	62K words
Local I/O capacity		512 pts	1,024 pts	2,048 pts	512 pts	1,024 pts	2,048 pts
Remote I/O capacity	SYSMAC BUS/2	1,024 pts	2,048 pts	2,048 pts	1,024 pts	2,048 pts	2,048 pts
	SYSMAC BUS	512 pts	1,024 pts	2,048 pts	512 pts	1,024 pts	1,024 pts
DM Area		8K words	24K words	24K words	8K words	24K words	24K words
Expansion DM Area		Not supported	Not supported	32K words each for 8 banks	Not supported	32K words each for 8 banks	32K words each for 8 banks
Timers		512	1,024	1,024	512	1,024	1,024
Counters		512	1,024	1,024	512	1,024	1,024
SFC steps		None	None	None	512	1,024	1,024
Step Flags		None	None	None	512	1,024	1,024
Transition Flags		None	None	None	512	1,024	1,024

Note The useable program capacity is 28K words or 60K words.

1-9 Improved Specifications

1-9-1 Upgraded Specifications

The following improvements are applicable to all CV500-CPU01-E and CV1000-CPU01-E CPUs with lot numbers in which the rightmost digit is 3 (□□□3) or higher.

- 1, 2, 3...** 1. The MLPX(110) (4-TO-16 DECODER) instruction has been improved to also function as a 8-to-256 decoder and the DMPX(111) (16-TO-4 ENCODER) instruction has been improved to also function as a 256-to-8 encoder. To enable this improvement, the digit designator (Di) has been changed as shown below.

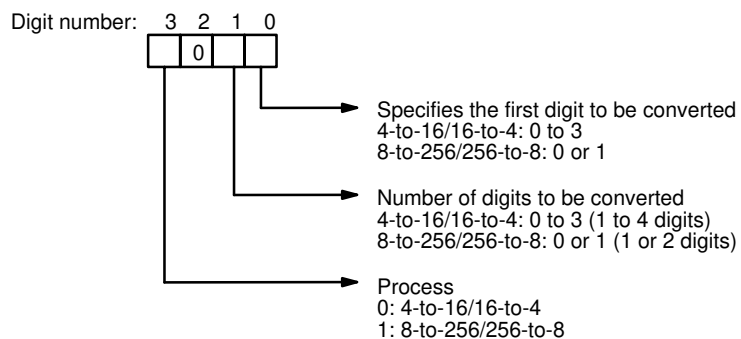

2. The following operating parameter has been added to the PC Setup.
- JMP(004) 0000 Processing
Y: Enable multiple usage (default)
N: Disable multiple usage