



Chipsmall Limited consists of a professional team with an average of over 10 year of expertise in the distribution of electronic components. Based in Hongkong, we have already established firm and mutual-benefit business relationships with customers from,Europe,America and south Asia,supplying obsolete and hard-to-find components to meet their specific needs.

With the principle of “Quality Parts,Customers Priority,Honest Operation,and Considerate Service”,our business mainly focus on the distribution of electronic components. Line cards we deal with include Microchip,ALPS,ROHM,Xilinx,Pulse,ON,Everlight and Freescale. Main products comprise IC,Modules,Potentiometer,IC Socket,Relay,Connector.Our parts cover such applications as commercial,industrial, and automotives areas.

We are looking forward to setting up business relationship with you and hope to provide you with the best service and solution. Let us make a better world for our industry!



## Contact us

Tel: +86-755-8981 8866 Fax: +86-755-8427 6832

Email & Skype: info@chipsmall.com Web: www.chipsmall.com

Address: A1208, Overseas Decoration Building, #122 Zhenhua RD., Futian, Shenzhen, China





PERFORMANCE SPECIFICATION	MIN	TYP	MAX	UNITS
Lower Frequency:			3318	MHz
Upper Frequency:	3467			MHz
Tuning Voltage:	0.1		16	VDC
Supply Voltage:	7.6	8.0	8.4	VDC
Output Power:	+3.0	+5.0	+7.0	dBm
Supply Current:		25	35	mA
Harmonic Suppression (2 <sup>nd</sup> Harmonic):		-15	-10	dBc
Pushing:		0.5	1.0	MHz/V
Pulling, all Phases:		3.0	5.0	MHz pk-pk
Tuning Sensitivity:		20		MHz/V
Phase Noise @ 10kHz offset:		-106	-104	dBc/Hz
Phase Noise @ 100kHz offset:		-129	-127	dBc/Hz
Load Impedance:		50		$\Omega$
Input Capacitance:			22	pF
Operating Temperature Range:	-40		+85	$^{\circ}$ C
Storage Temperature Range:	-45		+90	$^{\circ}$ C

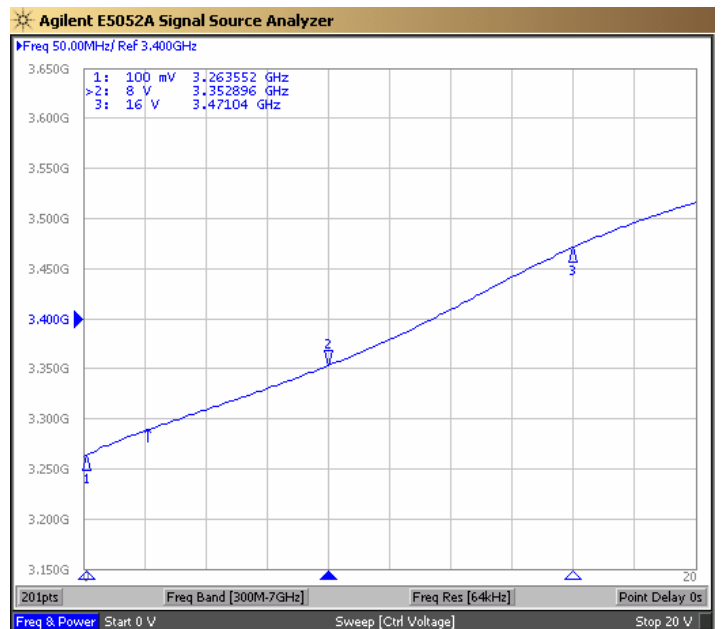
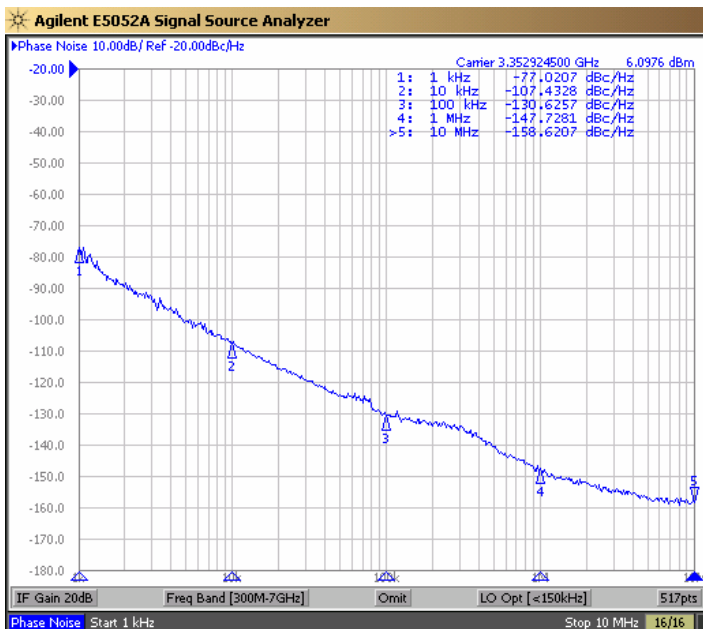

Phase Noise (1 Hz BW, Typical)

Tuning Curve (Typical)

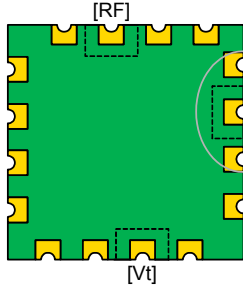

**BOTTOM VIEW**



 Gold Finish  
 Solder Mask

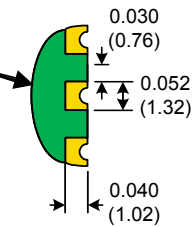

**SIDE VIEW**

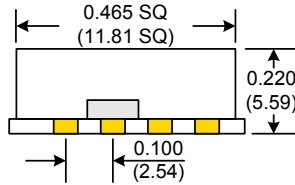

**TOP VIEW**

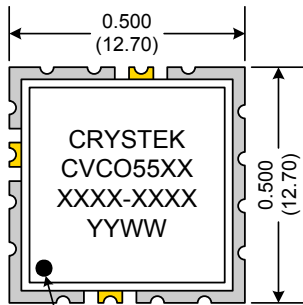

TOP ORIENTATION MARK

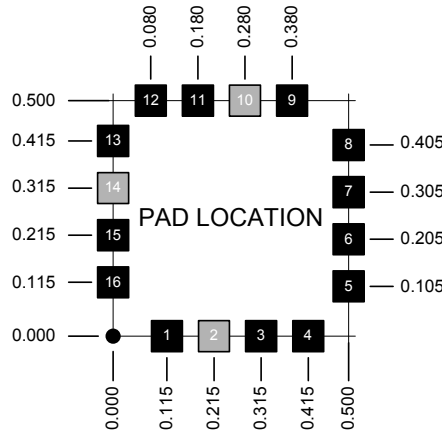

Pad	Connection
2	Vt
10	RF-OUTPUT
14	Vcc
Others	GROUND

- Unless otherwise specified, Dimensions are in: IN (mm)
- Pad Location Dimensions are in: Inches

**TAPE AND REEL**

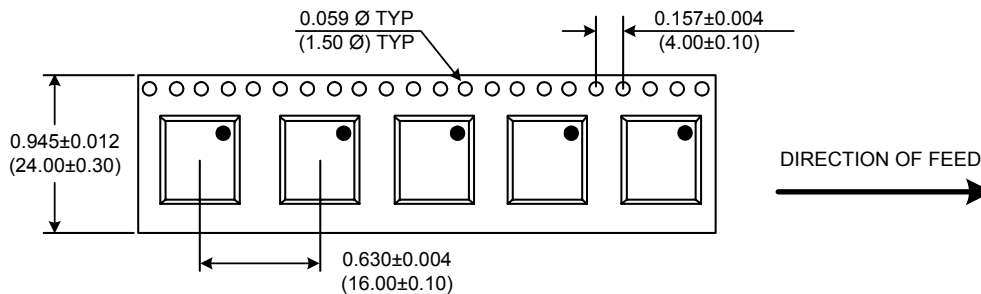

Drawing not to scale

**Product Control:**

Crystek Part Number:	CVCO55CC-3318-3467	Release Date:	15-Feb-08
Revision Level:	A	Responsible:	C. Vales

Specification is subject to change without notice