



Chipsmall Limited consists of a professional team with an average of over 10 year of expertise in the distribution of electronic components. Based in Hongkong, we have already established firm and mutual-benefit business relationships with customers from,Europe,America and south Asia,supplying obsolete and hard-to-find components to meet their specific needs.

With the principle of “Quality Parts,Customers Priority,Honest Operation,and Considerate Service”,our business mainly focus on the distribution of electronic components. Line cards we deal with include Microchip,ALPS,ROHM,Xilinx,Pulse,ON,Everlight and Freescale. Main products comprise IC,Modules,Potentiometer,IC Socket,Relay,Connector.Our parts cover such applications as commercial,industrial, and automotives areas.

We are looking forward to setting up business relationship with you and hope to provide you with the best service and solution. Let us make a better world for our industry!



## Contact us

Tel: +86-755-8981 8866 Fax: +86-755-8427 6832

Email & Skype: info@chipsmall.com Web: www.chipsmall.com

Address: A1208, Overseas Decoration Building, #122 Zhenhua RD., Futian, Shenzhen, China



# Socket Connectors

Socket connectors are typically used to interconnect PC boards or points on a backplane through headers or pins on .100 in. x .100 in. spacing.

They feature an advanced mechanical design which includes CW's patented offset-tine (Torq-Tite™) contact for positive gas-tight cable termination. The nose end of the contact provides a long, dual cantilever for a longer wiping action and improved self-cleaning of the mating pin. The extra length also results in a longer and more reliable working life.

The preassembled cover design allows fast, reliable assembly to extruded, bonded or laminated cable and features built-in cable alignment. These features permit the use of simplified termination equipment.

CW's socket connectors meet Mil-DTL-83503/7 specifications and are listed on the U.S. Defense Department's Qualified Products List.

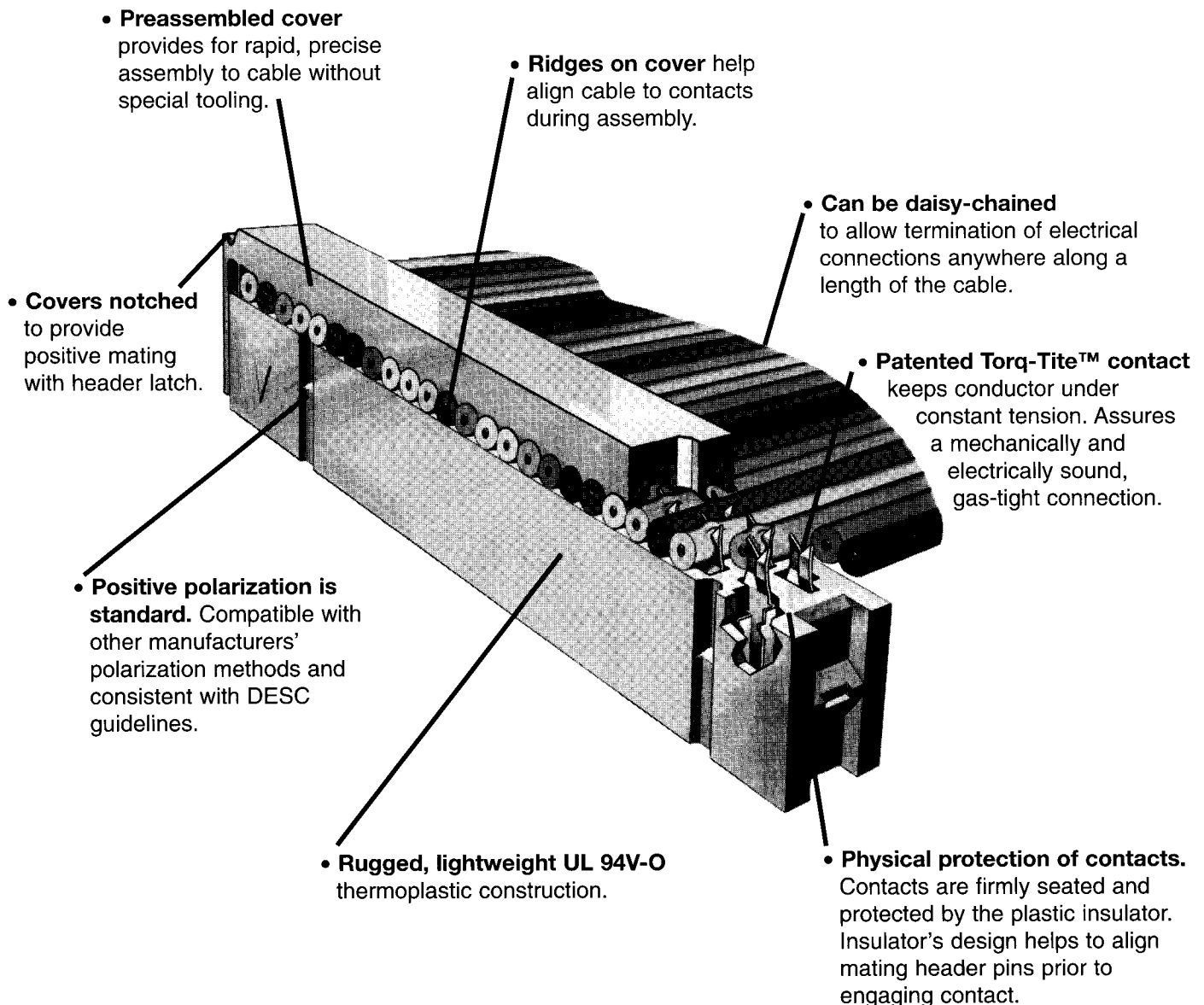

## Contact

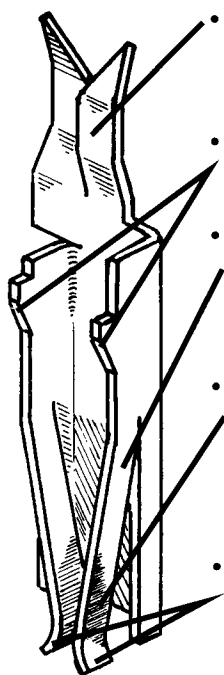

- **Torq-Tite™ offset tines** place conductor under tension. Reactive forces assure gas tightness
- **Double barbs bite into plastic**, retaining contact firmly in insulator.
- **Long cantilever of contact leaves** provide less angular deflection during insertion/withdrawal cycling.
- **Contact nose location** assures longer "wipe" on entering pin—to clean surfaces better and reduce electrical resistance.
- **Two contact leaves** insure integrity of contact, particularly under shock and vibration.

## Socket Connector Features

- 10, 14, 16, 20, 26, 34, 40, 50, 60 contact versions.
- 30  $\mu$  in. gold (in mating area) over 50  $\mu$  in. nickel-plated phosphor bronze contacts standard: optional gold plating thicknesses or tin-lead plating also available.
- **Fully interchangeable with competitive sockets and headers.** Meets Mil-DTL-83503 specifications; mateable with standard headers having contacts on .100 in. centers.
- **Insulated metal strain relief cover.** Protects contacts from excessive strain on cable.
- **Optional polarizing key** available.
- **Molded covers can be readily removed** and connectors reused.
- Mil-DTL-83503 approved.

## Socket Contact

All CW socket connectors incorporate our patented Torq-Tite™ contact for positive, gas-tight cable terminations. An extra long, dual-cantilevered contact on the mating end assures a reliable connection even under vibration. The contact's mating area is located near the face of the connector to provide a longer, self cleaning wipe on the corresponding header pins.

## Strain Relief

With the CWR-210 series sockets, an insulated, metal strain relief strap provides increased protection from forces applied to the cable, consistent with the requirements of Mil-DTL-83503. The connector is designed with a recess in the molded cover to allow the bend in the cable to fall within the connector's profile. This feature permits closer connector spacing than is possible with socket connectors from other manufacturers.

## Polarization

Choose your polarization method from one of three options:

**Method I:** Grooves in sockets CWR-210 and 220 match up with ribs on mating headers. (Mil-DTL-83503 approved method.)

**Method II:** Plastic key (**CWN-Key-1**) inserted into socket contact prevents mismatching if corresponding header contact is removed.

**Method III:** In addition to mating socket grooves and header slots, central polarizing key on one socket side (CWR-217 and CWR-227) mates with matching central header slot.

## Assembly

A factory preassembled cover eliminates the need for complicated assembly tooling. The connector cover aligns the cable to the contacts. The individual conductors are terminated by applying opposing parallel forces on the connector cover and base.

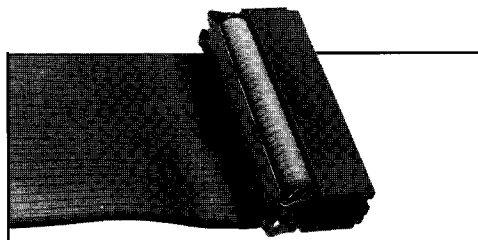

Method I

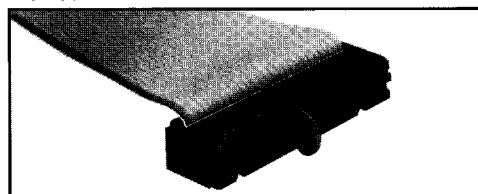

Method II

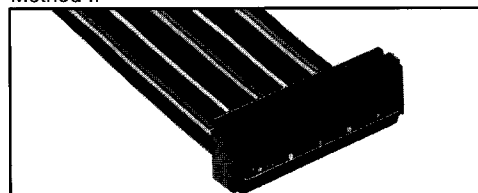

Method III

# Sockets

## Engineering Dimensions

### Dimensions

Socket Connector  
with Metal Strain Relief Strap

CONNECTOR DIMENSIONS				
NO. CONTS.	A	B	C	D
10	.400 (10.16)	.515 (13.08)	.677 (17.20)	.690 (17.53)
14	.600 (15.24)	.715 (18.16)	.877 (22.28)	.890 (22.61)
16	.700 (17.78)	.815 (20.70)	.977 (24.82)	.990 (25.15)
20	.900 (22.86)	1.015 (25.78)	1.177 (29.90)	1.190 (30.23)
26	1.200 (30.48)	1.315 (33.40)	1.477 (37.52)	1.490 (37.85)
34	1.600 (40.64)	1.715 (43.56)	1.877 (47.68)	1.890 (48.01)
40	1.900 (48.26)	2.015 (51.18)	2.177 (55.30)	2.190 (55.63)
50	2.400 (60.96)	2.515 (63.88)	2.677 (68.00)	2.690 (68.33)
60	2.900 (73.66)	3.015 (76.58)	3.177 (80.70)	3.190 (81.03)

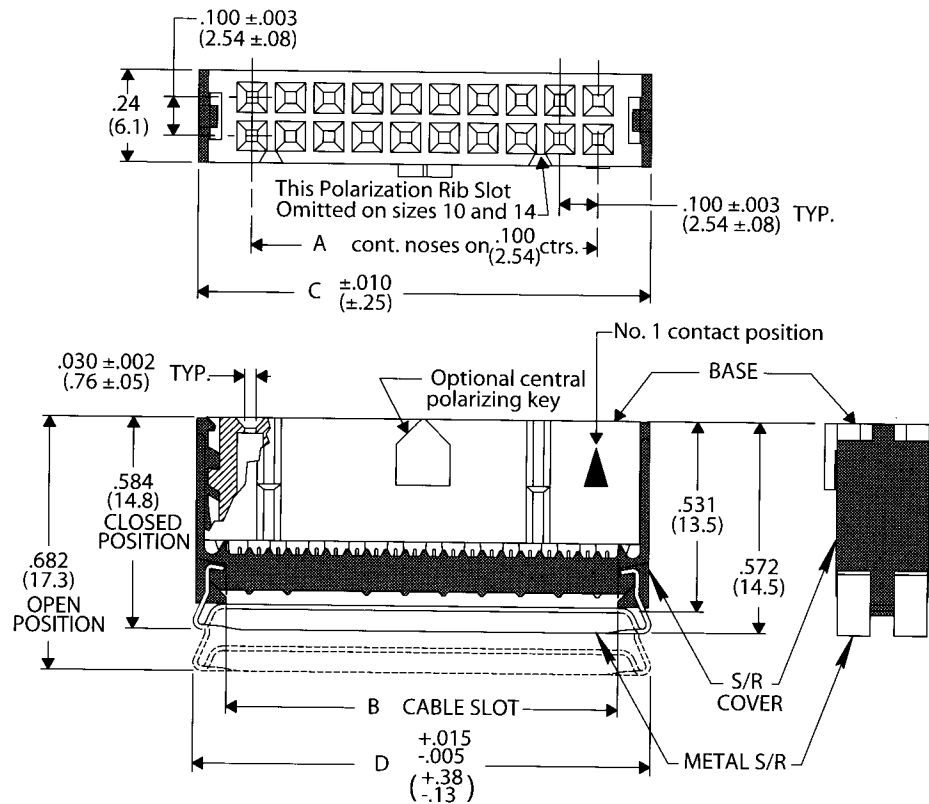

Socket Connector  
with Non-Strain Relief Cover

CONNECTOR DIMENSIONS			
NO. CONTS.	A	B	C
10	.400 (10.16)	.515 (13.08)	.677 (17.20)
14	.600 (15.24)	.715 (18.16)	.877 (22.28)
16	.700 (17.78)	.815 (20.70)	.977 (24.82)
20	.900 (22.86)	1.015 (25.78)	1.177 (29.90)
26	1.200 (30.48)	1.315 (33.40)	1.477 (37.52)
34	1.600 (40.64)	1.715 (43.56)	1.877 (47.68)
40	1.900 (48.26)	2.015 (51.18)	2.177 (55.30)
50	2.400 (60.96)	2.515 (63.88)	2.677 (68.00)
60	2.900 (73.66)	3.015 (76.58)	3.177 (80.70)

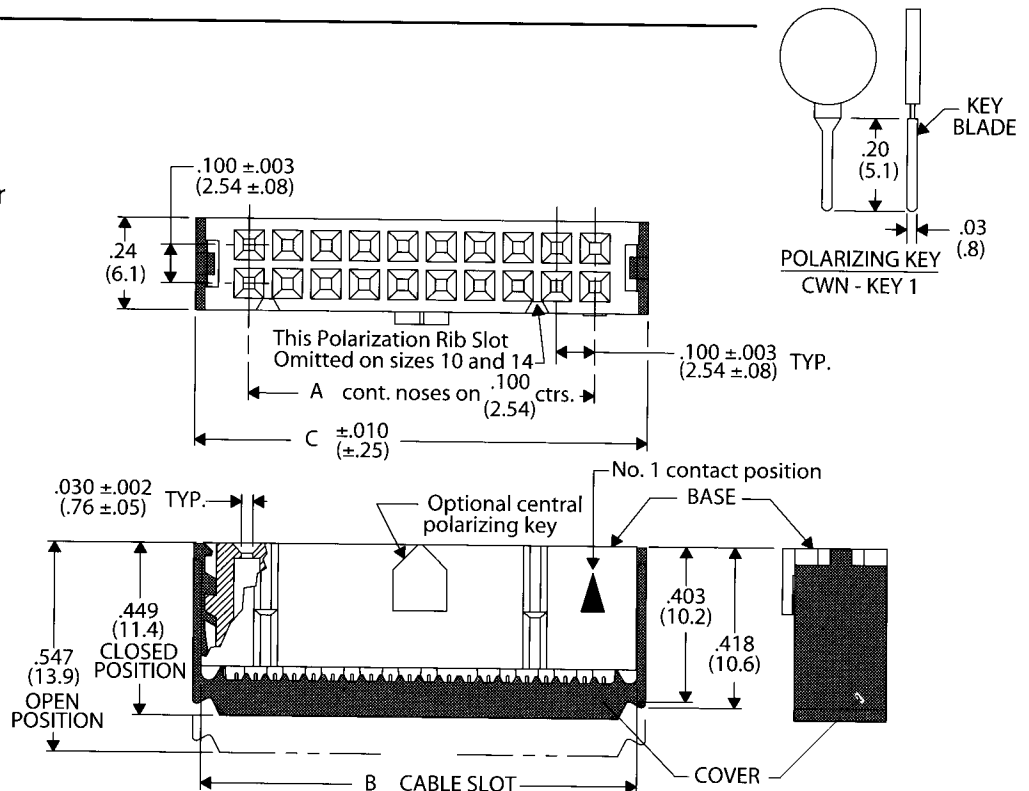

# Specifications and Ordering Information

## Specifications

- Contacts: phosphor bronze, standard.
- Contact Plating: 30µ in. gold (in mating area) over 50µ in. nickel, standard; 10µ in. gold (in mating area) over 50µ in. nickel, optional; 50µ in. gold (in mating area) over 50µ in. nickel, optional; 100µ in. 60/40 tin-lead optional.
- Insulator Material: UL 94V-O flame-retardant thermoplastic
- Strain Relief Strap Material: insulated stainless steel
- Color: blue
- Operating Temperature: -55°C to +125°C
- Current Rating: 1A (maximum) per contact
- Dielectric Withstand Voltage: greater than 500 Vdc at sea level
- Insulation Resistance: greater than 5x10<sup>9</sup> ohms
- Withdrawal force 2-8 oz/contact, typical
- Cover pull-off force 8 oz/contact minimum (force along contacts' primary axes)

## How to Order Socket Connectors

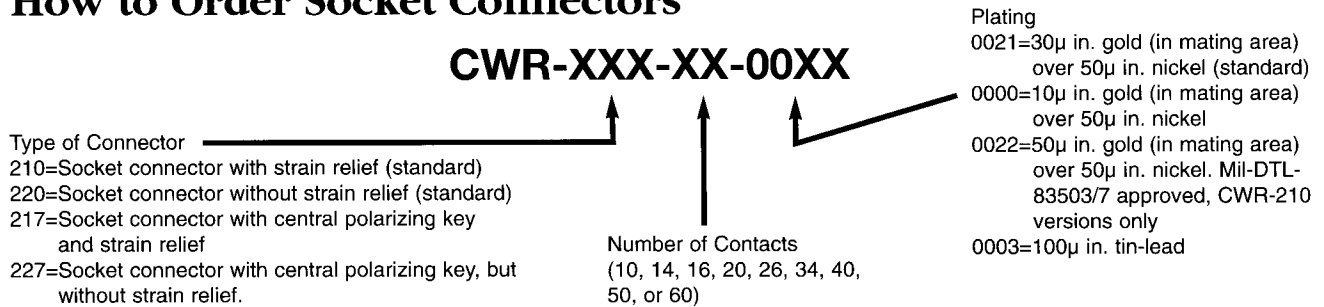

## How to Order Socket Cable Assemblies

Cable assemblies with two socket connectors on a prescribed length of color-coded cable are available with the connectors oriented per drawings 9-1 or 9-2. (#1 contacts oriented on brown conductor.) For other lengths, orientations, numbers or combinations of connectors, contact the factory or your local value-added distributor.

