



Chipsmall Limited consists of a professional team with an average of over 10 year of expertise in the distribution of electronic components. Based in Hongkong, we have already established firm and mutual-benefit business relationships with customers from,Europe,America and south Asia,supplying obsolete and hard-to-find components to meet their specific needs.

With the principle of “Quality Parts,Customers Priority,Honest Operation,and Considerate Service”,our business mainly focus on the distribution of electronic components. Line cards we deal with include Microchip,ALPS,ROHM,Xilinx,Pulse,ON,Everlight and Freescale. Main products comprise IC,Modules,Potentiometer,IC Socket,Relay,Connector.Our parts cover such applications as commercial,industrial, and automotives areas.

We are looking forward to setting up business relationship with you and hope to provide you with the best service and solution. Let us make a better world for our industry!



Contact us

Tel: +86-755-8981 8866 Fax: +86-755-8427 6832

Email & Skype: info@chipsmall.com Web: www.chipsmall.com





Address: A1208, Overseas Decoration Building, #122 Zhenhua RD., Futian, Shenzhen, China

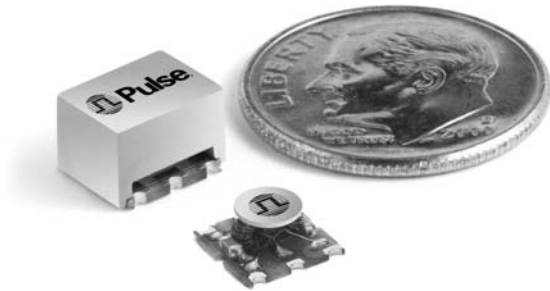

RF SPLITTER/COMBINERS

High Isolation for Cable Media Products and Distribution Equipment : 2-Way; 0°



-  High isolation splitters
-  Operating bandwidth: 5MHz to 1000MHz
-  Excellent amplitude balance
-  Ideal for cable distribution equipment and set top box applications
-  235°C peak IR reflow temperature rating

Electrical Specifications @ 25°C — Operating Temperature -40°C to +85°C

Part Number	Frequency (MHz)	Z (Ω)	Isolation			Return Loss		
			@ 5-40MHz (dB TYP/MIN)	@ 40-600MHz (dB TYP/MIN)	@ 600-1000MHz (dB TYP/MIN)	@ 5-40MHz (dB TYP/MIN)	@ 40-600MHz (dB TYP/MIN)	@ 600-1000MHz (dB TYP/MIN)
CX4012L	5 - 1000	75	20/16.5	27/22	27/22	16/12.5	21/18.5	19/18
Part Number	Frequency (MHz)	Z (Ω)	@ 5-500MHz (dB TYP/MIN)	@ 501-870MHz (dB TYP/MIN)	@ 871-1000MHz (dB TYP/MIN)	@ 5-500MHz (dB TYP/MIN)	@ 501-870MHz (dB TYP/MIN)	@ 871-1000MHz (dB TYP/MIN)
CX4024	5 - 1000	75	30/20	25/18	18/15	30/23	25/20	17/10

Additional Specifications

Part Number	Insertion Loss (Above 3dB)				Amplitude Unbalance		
	@ 5-40MHz (dB TYP/MAX)	@ 40-600MHz (dB TYP/MAX)	@ 600-870MHz (dB TYP/MAX)	@ 870-1000MHz (dB TYP/MAX)	@ 5-40MHz (dB TYP/MAX)	@ 40-1000MHz (dB TYP/MAX)	
CX4012L	0.4/0.8	0.4/0.6	0.65/0.85	1.0/1.2	0.3/0.4	0.2/0.3	
Part Number	@ 5-500MHz (dB TYP/MAX)	@ 501-870MHz (dB TYP/MAX)	@ 871-1000MHz (dB TYP/MAX)	@ 5-500MHz (dB MAX)	@ 501-870MHz (dB MAX)	@ 871-1000MHz (dB MAX)	
CX4024	0.5/0.8	0.8/1.0	1.0/1.3	0.1	0.2	0.3	

NOTE: Optional Tape & Reel packaging can be ordered by adding a "T" suffix to the part number (ex: CX4012LT).

Mechanicals

CX4024

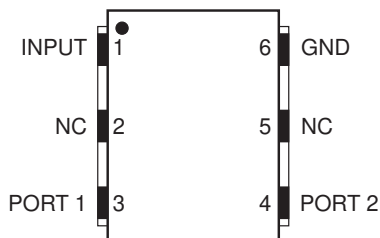

Power Rating: 1 Watt, MAX

Dimensions: $\frac{\text{Inches}}{\text{mm}}$

Unless otherwise specified, all tolerances are $\pm \frac{.005}{0,13}$

Weight0.35 grams
Tape & Reel850/reel
Tube65/tube

CX4012L

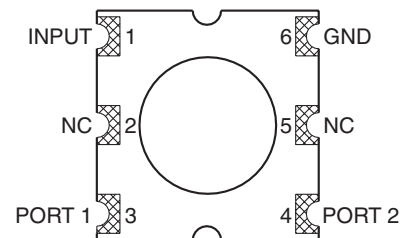

Power Rating: 1 Watt, MAX

Dimensions: $\frac{\text{Inches}}{\text{mm}}$

Unless otherwise specified, all tolerances are $\pm \frac{.005}{0,13}$

Weight0.35 grams
Tape & Reel2200/reel

RF SPLITTER/COMBINERS

High Isolation for Cable Media Products and Distribution Equipment : 2-Way; 0°



Mechanicals

CX4024

CX4012L

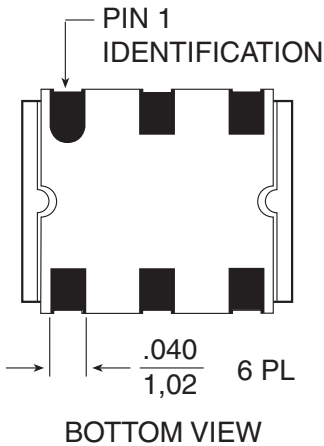
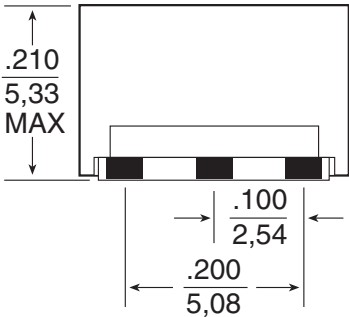
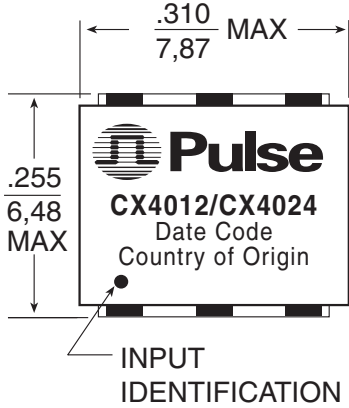

BOTTOM VIEW

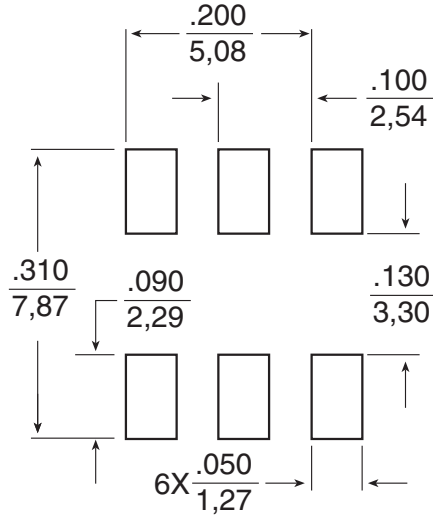

**SUGGESTED PAD LAYOUT
(Common to all parts)**

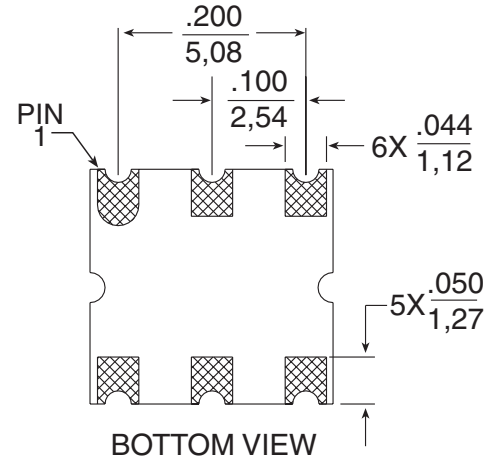
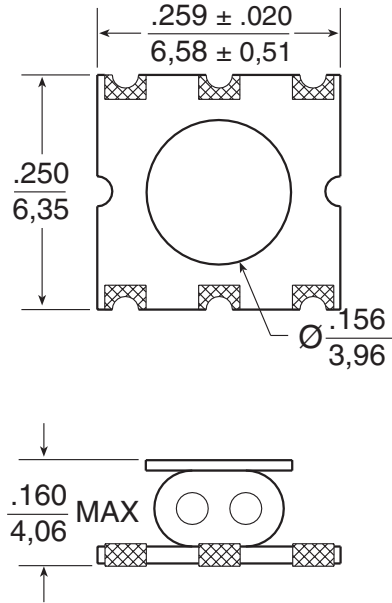

BOTTOM VIEW

Dimensions: $\frac{\text{Inches}}{\text{mm}}$

Unless otherwise specified, all tolerances are $\pm \frac{.005}{0,13}$

Weight035 grams
Tape & Reel850/reel
Tube65/tube

Dimensions: $\frac{\text{Inches}}{\text{mm}}$

Unless otherwise specified, all tolerances are $\pm \frac{.005}{0,13}$

Weight035 grams
Tape & Reel2200/reel

RF SPLITTER/COMBINER

High Isolation for Cable Media Products and Distribution Equipment : 2-Way; 0°



CX4012L and CX4024 — Typical Performance @ 25°C

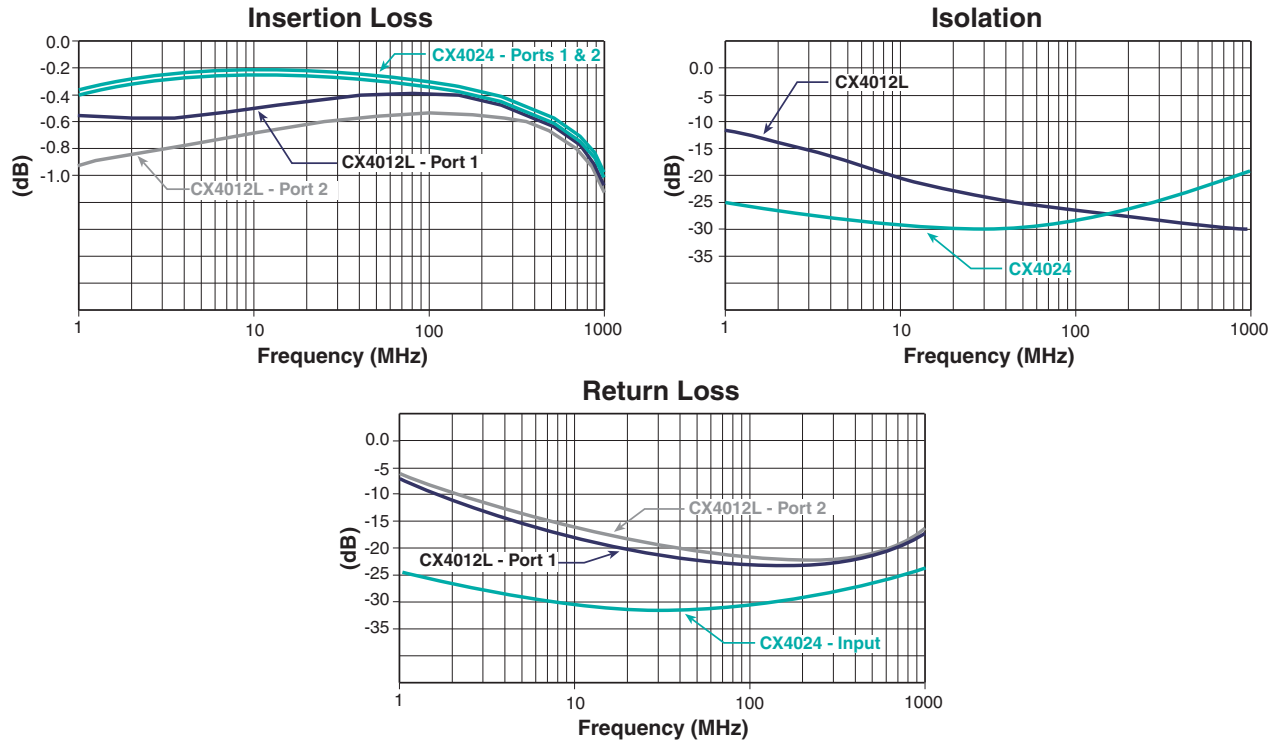

Tape and Reel Specifications

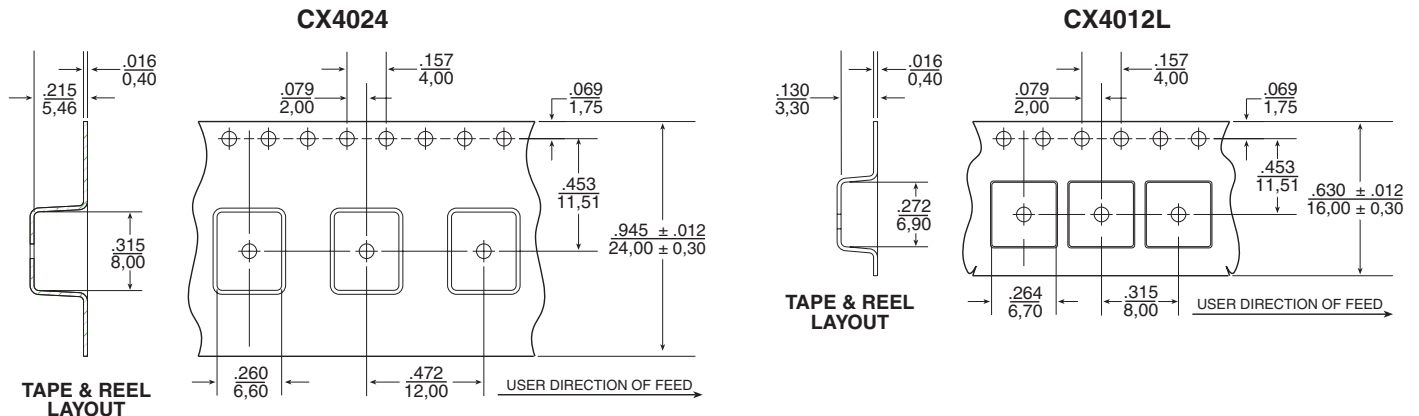

For More Information :

UNITED STATES (Worldwide)	UNITED KINGDOM (Northern Europe)	FRANCE (Southern Europe)	SINGAPORE (Southern Asia)	TAIWAN, R.O.C. (Northern Asia)	HONG KONG (China/Hong Kong)	DISTRIBUTOR
12220 World Trade Drive San Diego, CA 92128 U.S.A. http://www.pulseeng.com TEL: 858 674 8100 FAX: 858 674 8262	3 Huxley Road Surrey Research Park Guildford, Surrey GU2 5RE United Kingdom TEL: 44 1483 401700 FAX: 44 1483 401701	Zone Industrielle F-39270 Orgelet France TEL: 33 3 84 35 04 04 FAX: 33 3 84 25 46 41	150 Kampong Ampat #07-01/02 KA Centre Singapore 368324 TEL: 65 6287 8998 FAX: 65 6280 0080	3F-4, No. 81, Sec. 1 HsinTai Wu Road Hsi-Chih, Taipei Hsien Taiwan, R.O.C. Tel: 886 2 2698 0228 FAX: 886 2 2698 0948	9/F, Phase 2, Tai Sang Shatin Warehouse Centre 6 Wong Chuk Yeung Street Fotan, Shatin, Hong Kong TEL: 852 2788 6588 FAX: 852 2776 1055	

Performance warranty of products offered on this data sheet is limited to the parameters specified. Data is subject to change without notice. Other brand and product names mentioned herein may be trademarks or registered trademarks of their respective owners.