



Chipsmall Limited consists of a professional team with an average of over 10 year of expertise in the distribution of electronic components. Based in Hongkong, we have already established firm and mutual-benefit business relationships with customers from,Europe,America and south Asia,supplying obsolete and hard-to-find components to meet their specific needs.

With the principle of “Quality Parts,Customers Priority,Honest Operation,and Considerate Service”,our business mainly focus on the distribution of electronic components. Line cards we deal with include Microchip,ALPS,ROHM,Xilinx,Pulse,ON,Everlight and Freescale. Main products comprise IC,Modules,Potentiometer,IC Socket,Relay,Connector.Our parts cover such applications as commercial,industrial, and automotives areas.

We are looking forward to setting up business relationship with you and hope to provide you with the best service and solution. Let us make a better world for our industry!



Contact us

Tel: +86-755-8981 8866 Fax: +86-755-8427 6832

Email & Skype: info@chipsmall.com Web: www.chipsmall.com

Address: A1208, Overseas Decoration Building, #122 Zhenhua RD., Futian, Shenzhen, China



CXA-L0512-NJL

Non-dimming/Connector Type

■ Features

- 1 output
- UL60950 approved
- Applicable panel size*: 3 to 15 inches
- In the high-voltage generator(a terminal and a pattern), an anti-dust measure by silicone application is taken.
(Notice) Applicable panel size becomes a standard.

■ Applications



CXA-L0512-NJL Specifications (Please refer to each specification before use)

Electrical Characteristics

Item	Unit	Symbol	Specification			Condition			Remark
			min	typ	max	Vin(V)	Ta(°C)	RL(kΩ)	
Output Current	mArms	Iout	4.5	5.0	5.5	12±0.12	23±5	120	
			4.0	5.0	6.0	12±0.6	0 to +60	110 to 130	
Input Current	A	Iin	-	0.3	0.5	12±0.6	0 to +60	110 to 130	
Frequency	kHz	Freq	33	40	47	12±0.6	0 to +60	110 to 130	
Open Circuit Voltage	Vrms	Vopen	1400	1500	-	12±0.6	0 to +60	∞	Open load

Other Specifications

Dimming Function		No
Operating Temperature	°C	0 to +60
Storage Temperature	°C	-30 to +85
Operating Humidity Ratio	RH%	95Max
Safety Standard		UL60950
Weight	g	11
Dimensions(WxDxH)	mm	80.5x20.5x8 (*1)
Fused Input		Yes
Remote ON / OFF		No
Alarm Signal Function		No
Shutdown Function		No
Silicone Coating on High Voltage Area		Yes

(*1) These dimensions are indicated the maximum.

■ Conformity to RoHS Directive

This means that, in conformity with EU Directive 2002/95/EC, lead, cadmium, mercury, hexavalent chromium, and specific bromine-based flame retardants, PBB and PBDE, have not been used, except for exempted applications.

Outline Drawing

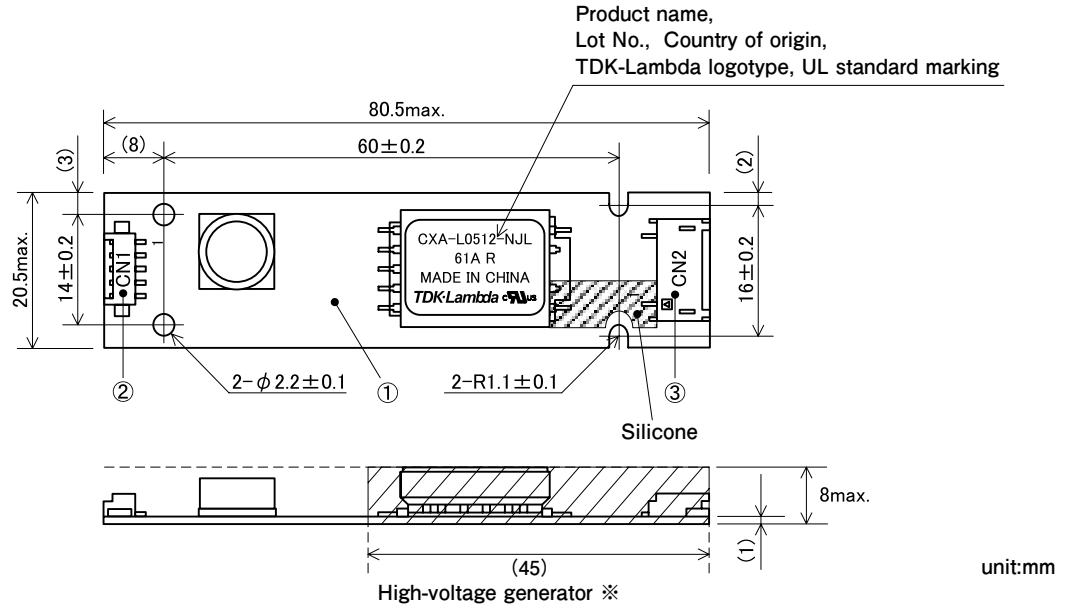

High-voltage generator ※
(The entire surface within a range of 45mm away from the end of the basein)
※From high-voltage generator, please secure space distance more than 3mm in top and bottom right and left.

Connector

Connector number	Part number	Model	Quantity	Remarks	Recommended applicable connector
①	Printed circuit board PCB	Composite (CEM-3)	1	UL94V-0 t=1.0	—
②	Input connector CN1	53261-0571	1	Molex Inc.	51021-0500
③	Output connector CN2	SM02 (8.0) B-BHS-1-TB (LF)(SN)	1	JST Mfg. Co., Ltd.	BHR-03VS-1

Terminal Numbers And Functions

Input side CN1

Terminal number	Symbol	Rated voltage
CN1-1	V _{in}	12V
CN1-2	GND	0V
CN1-3	N.C.	—
CN1-4		
CN1-5		

Output side CN2

Terminal number	Symbol	Rated voltage
CN2-1	V _{HIGH1}	750Vrms
CN2-2	N.C.	—
CN2-3	V _{HIGH2}	750Vrms

※ The output is floating.
Both CN2-1 and CN2-3 become high voltage.

Connections

