



Chipsmall Limited consists of a professional team with an average of over 10 year of expertise in the distribution of electronic components. Based in Hongkong, we have already established firm and mutual-benefit business relationships with customers from,Europe,America and south Asia,supplying obsolete and hard-to-find components to meet their specific needs.

With the principle of “Quality Parts,Customers Priority,Honest Operation,and Considerate Service”,our business mainly focus on the distribution of electronic components. Line cards we deal with include Microchip,ALPS,ROHM,Xilinx,Pulse,ON,Everlight and Freescale. Main products comprise IC,Modules,Potentiometer,IC Socket,Relay,Connector.Our parts cover such applications as commercial,industrial, and automotives areas.

We are looking forward to setting up business relationship with you and hope to provide you with the best service and solution. Let us make a better world for our industry!



## Contact us

Tel: +86-755-8981 8866 Fax: +86-755-8427 6832

Email & Skype: info@chipsmall.com Web: www.chipsmall.com

Address: A1208, Overseas Decoration Building, #122 Zhenhua RD., Futian, Shenzhen, China



## Features

- Internal DCXO for continuous glitch-free operation
- Zero input-output propagation delay
- 100 ps typical output cycle-to-cycle jitter
- 110 ps typical output-output skew
- 1 MHz to 200 MHz reference input
- Supports industry standard input crystals
- 200 MHz (commercial), 166 MHz (industrial) outputs
- 5 V tolerant inputs
- Phase-locked loop (PLL) bypass mode
- Dual reference inputs
- 28-pin SSOP
- Split 2.5 V or 3.3 V output power supplies
- 3.3 V core power supply
- Industrial temperature available

## Functional Description

The CY23FS08 is a FailSafe™ Zero Delay Buffer with two reference clock inputs and eight phase-aligned Buffer outputs. The device provides an optimum solution for applications where continuous operation is required in the event of a primary clock failure.

Continuous, glitch-free operation is achieved by using a DCXO, which serves as a redundant clock source in the event of a reference clock failure by maintaining the last frequency and phase information of the reference clock.

The unique feature of the CY23FS08 is that the DCXO is in fact the primary clocking source, which is synchronized (phase-aligned) to the external reference clock. When this external clock is restored, the DCXO automatically resynchronizes to the external clock.

The frequency of the crystal connected to the DCXO, must be chosen to be an integer factor of the frequency of the reference clock. This factor is set by four select lines: S[4:1], see [Configuration Table](#) on page 4. The CY23FS08 has three split power supplies; one for core, another for Bank A outputs, and the third for Bank B outputs. Each output power supply, except VDDC can be connected to either 2.5 V or 3.3 V. VDDC is the power supply pin for internal circuits and must be connected to 3.3 V.

For a complete list of related documentation, click [here](#).

## Logic Block Diagram

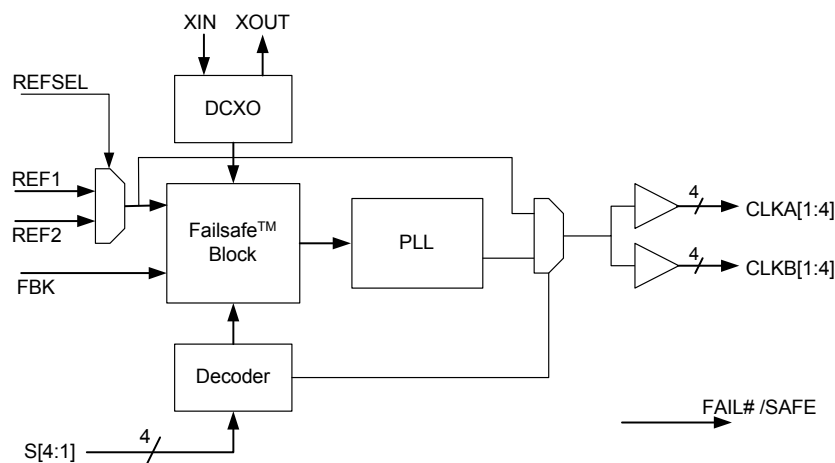

**Contents**

<b>Pinouts</b> .....	<b>3</b>	<b>Package Diagram</b> .....	<b>14</b>
<b>Pin Definitions</b> .....	<b>3</b>	<b>Acronyms</b> .....	<b>15</b>
<b>Configuration Table</b> .....	<b>4</b>	<b>Document Conventions</b> .....	<b>15</b>
<b>FailSafe Function</b> .....	<b>4</b>	Units of Measure .....	15
<b>XTAL Selection Criteria and Application Example</b> .....	<b>7</b>	<b>Document History Page</b> .....	<b>16</b>
<b>Absolute Maximum Conditions</b> .....	<b>9</b>	<b>Sales, Solutions, and Legal Information</b> .....	<b>17</b>
<b>Recommended Pullable Crystal Specifications</b> .....	<b>9</b>	Worldwide Sales and Design Support .....	17
<b>Operating Conditions</b> .....	<b>10</b>	Products .....	17
<b>DC Electrical Characteristics</b> .....	<b>10</b>	PSoC@Solutions .....	17
<b>Thermal Resistance</b> .....	<b>10</b>	Cypress Developer Community .....	17
<b>Switching Characteristics</b> .....	<b>11</b>	Technical Support .....	17
<b>Switching Waveforms</b> .....	<b>12</b>		
<b>Ordering Information</b> .....	<b>13</b>		
Ordering Code Definitions .....	13		

## Pinouts

Figure 1. 28-pin SSOP pinout

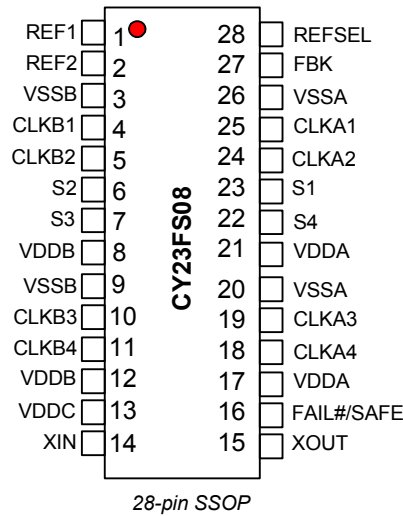

## Pin Definitions

Pin Number	Pin Name	Description
1, 2	REF1, REF2	Reference clock inputs. <sup>[1]</sup> 5 V tolerant.
4, 5, 10, 11	CLKB[1:4]	Bank B clock outputs. <sup>[2, 3]</sup>
25, 24, 19, 18	CLKA[1:4]	Bank A clock outputs. <sup>[2, 3]</sup>
27	FBK	Feedback input to the PLL. <sup>[2]</sup>
23, 6, 7, 22	S[1:4]	Frequency select pins/PLL and DCXO bypass. <sup>[4]</sup>
14	XIN	Reference crystal input.
15	XOUT	Reference crystal output.
16	FAIL#/SAFE	Valid reference indicator. A high level indicates a valid reference input.
13	VDDC	3.3 V power supply for the internal circuitry.
8, 12	VDDDB	2.5 V or 3.3 V power supply for Bank B outputs.
3, 9	VSSB	Ground.
17, 21	VDDA	2.5 V or 3.3 V power supply for Bank A outputs.
20, 26	VSSA	Ground.
28	REFSEL	Reference select. Selects the active reference clock from either REF1 or REF2. When REFSEL = 1, REF1 is selected. When REFSEL = 0, REF2 is selected.

### Notes

1. Weak pull downs on these inputs.
2. For normal operation, connect either one of the eight clock outputs to the FBK input.
3. Weak pull downs on all CLK outputs.
4. Weak pull ups on these inputs.

### Configuration Table

S[4:1]	XTAL (MHz)		REF (MHz)		OUT (MHz)		REF:OUT Ratio	REF:XTAL Ratio	Out:XTAL Ratio
	Min	Max	Min	Max	Min	Max			
0000			PLL and DCXO Bypass mode						
1000	8.33	30	16.67	60.00	8.33	30.00	÷2	2	1
1110	9.50	30	57.00	180.00	28.50	90.00	÷2	6	3
0101	8.50	30	6.80	24.00	1.70	6.00	÷4	4/5	1/5
1011	8.33	30	25.00	90.00	6.25	22.50	÷4	3	3/4
0011	8.33	30	2.78	10.00	2.78	10.00	×1	1/3	1/3
1001	8.33	30	8.33	30.00	8.33	30.00	×1	1	1
1111	8.00	25	32.00	100.00	32.00	100.00	×1	4	4
1100	8.00	25	64.00	200.00	64.00	200.00	×1	8	8
0001	8.33	30	1.04	3.75	2.08	7.50	×2	1/8	1/4
0110	8.33	30	4.17	15.00	8.33	30.00	×2	1/2	1
1101	8.33	30	16.67	60.00	33.33	120.00	×2	2	4
0100	8.33	30	4.17	15.00	16.67	60.00	×4	1/2	2
1010	8.33	30	12.50	45.00	50.00	180.00	×4	3/2	6
0010	8.33	30	1.39	5.00	11.11	40.00	×8	1/6	4/3
0111	8.33	30	6.25	22.50	50.00	180.00	×8	3/4	6

### FailSafe Function

The CY23FS08 is targeted at clock distribution applications that requires or may require continued operation if the main reference clock fails. Existing approaches to this requirement have used multiple reference clocks with either internal or external methods to switch between references. The problem with this technique is that it leads to interruptions (or glitches) when transitioning from one reference to another, often requiring complex external circuitry or software to maintain system stability. The technique implemented in this design completely eliminates any switching of references to the PLL, greatly simplifying system design.

The CY23FS08 PLL is driven by the crystal oscillator, which is phase-aligned to an external reference clock so that the output of the device is effectively phase-aligned to reference via the external feedback loop. This is accomplished by using a digitally

controlled capacitor array to pull the crystal frequency over an approximate range of ±300 ppm from its nominal frequency.

In this mode, if the reference frequency fails (that is, stops or disappears), the DCXO maintains its last setting and a flag signal (FAIL#/SAFE) is set to indicate failure of the reference clock.

The CY23FS08 provides four select bits, S1 through S4 to control the reference to crystal frequency ratio. The DCXO is internally tuned to the phase and frequency of the external reference only when the reference frequency divided by this ratio is within the DCXO capture range. If the frequency is out of range, a flag is set on the FAIL#/SAFE pin notifying the system that the selected reference is not valid. If the reference moves in range, then the flag is cleared, indicating to the system that the selected reference is valid.

Figure 2. Fail#/Safe Timing for Input Reference Failing Catastrophically

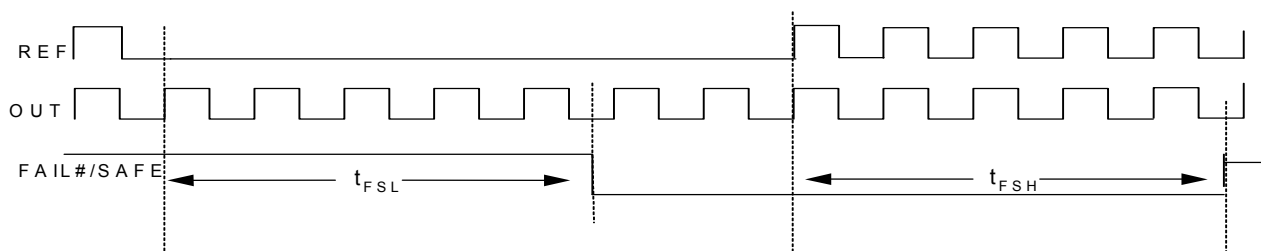

Figure 3. Fail#/Safe Timing Formula

$$t_{FSL(max)} = 2 ( t_{REF} \times n ) + 25 ns$$

$$n = \frac{F_{REF}}{F_{XTAL}} = 4 \text{ (in above example)}$$

$$t_{FSH(min)} = 12 ( t_{REF} \times n ) + 25 ns$$

Table 1. Failsafe Timing Table

Parameter	Description	Conditions	Min	Max	Unit
t <sub>FSL</sub>	Fail#/Safe Assert Delay	Measured at 80% to 20%, Load = 15 pF		See Figure 3	ns
t <sub>FSH</sub>	Fail#/Safe Deassert Delay	Measured at 80% to 20%, Load = 15 pF	See Figure 3		ns

Figure 4. FailSafe Timing Diagram: Input Reference Slowly Drifting Out of FailSafe Capture Range

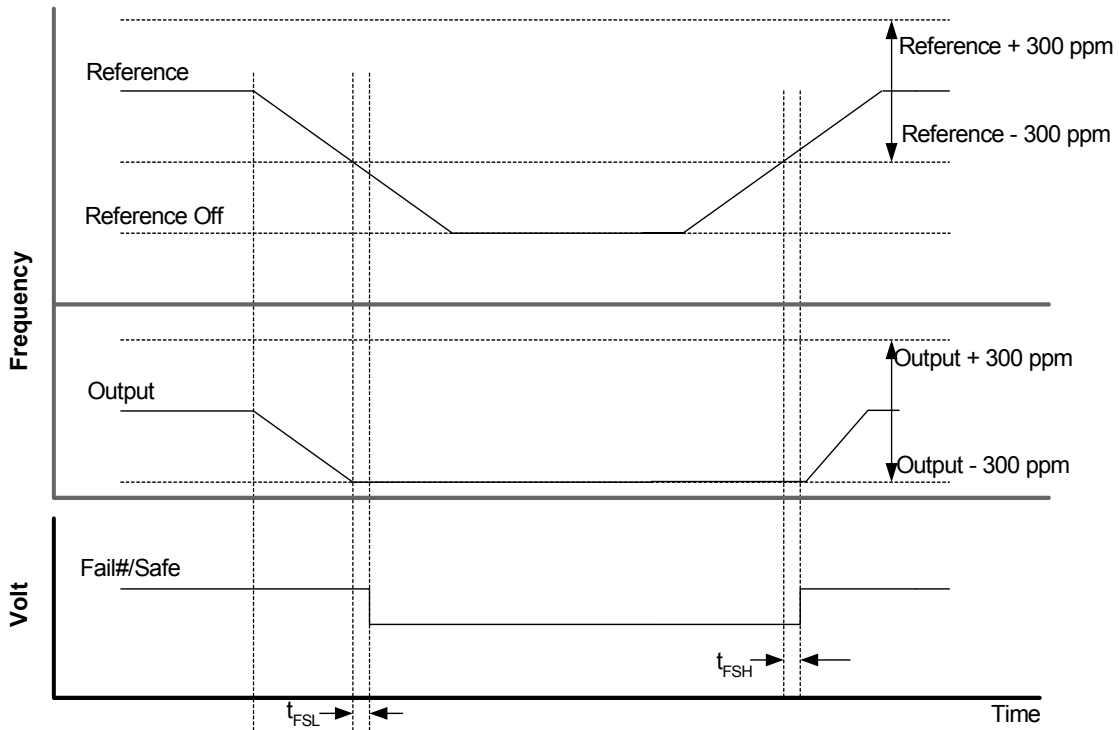

**Figure 5. FailSafe Reference Switching Behavior**

**Failsafe typical frequency settling time**

Initial valid Ref1 = 20 MHz +100 ppm,  
then switching to REF2 = 20 MHz

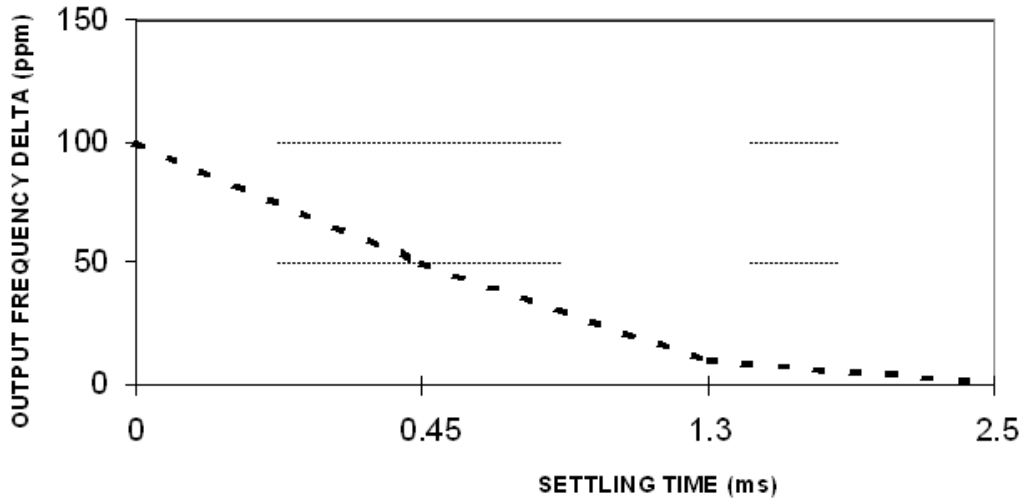

Because of the DCXO architecture, the CY23FS08 has a much lower bandwidth than a typical PLL-based clock generator. This is shown in Figure 6. This low bandwidth makes the CY23FS08 also useful as a jitter attenuator. The loop bandwidth curve is also known as the jitter transfer curve.

**Figure 6. FailSafe Effective Loop Bandwidth (min)**

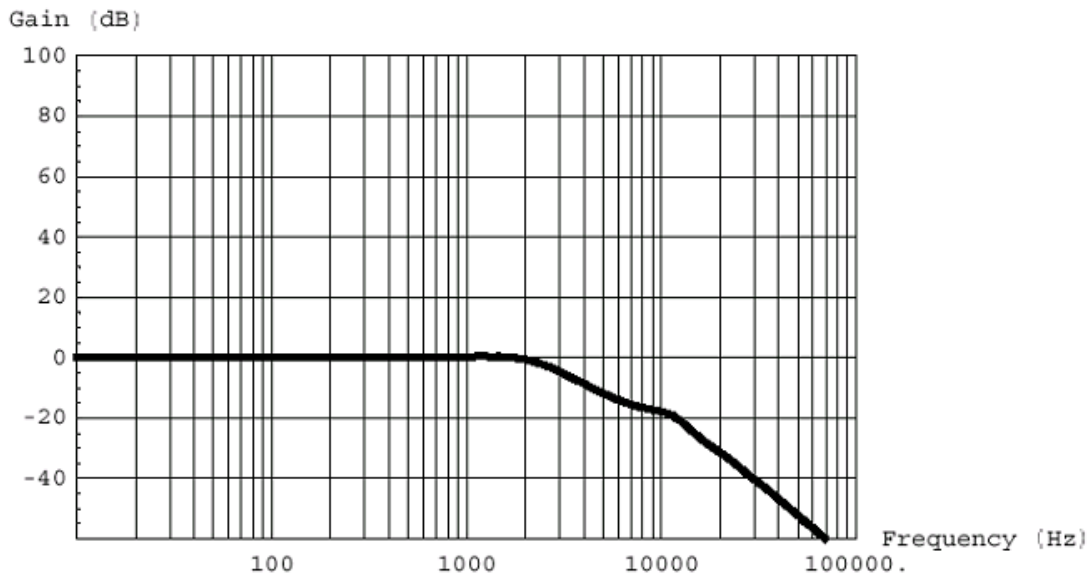

## XTAL Selection Criteria and Application Example

Selecting the appropriate XTAL ensures the FailSafe device is able to span an appropriate frequency of operation. Also, the XTAL parameters determine the holdover frequency stability. Critical parameters are given here. Cypress recommends that you choose:

- Low C0/C1 ratio (240 or less) so that the XTAL has enough range of pullability.
- Low temperature frequency variation
- Low manufacturing frequency tolerance

### Example:

$$C_{LOADMIN} = (12 \text{ pF IC input cap} + 0 \text{ pF pulling cap} + 6 \text{ pF trace cap on board}) / 2 = 9 \text{ pF}$$

$$C_{LOADMAX} = (12 \text{ pF IC input cap} + 48 \text{ pF pulling cap} + 6 \text{ pF trace cap on board}) / 2 = 33 \text{ pF}$$

$$\text{Pull Range} = (f_{C_{LOADMIN}} - f_{C_{LOADMAX}}) / f_{C_{LOADMIN}} = (C1 / 2) \times [(1 / (C0 + C_{LOADMIN})) - (1 / (C0 + C_{LOADMAX}))]$$

$$\text{Pull Range in ppm} = (C1 / 2) \times [(1 / (C0 + C_{LOADMIN})) - (1 / (C0 + C_{LOADMAX}))] \times 10^6$$

### ■ Low aging

C0 is the XTAL shunt capacitance (3 pF to 7 pF typ).

C1 is the XTAL motional capacitance (10 fF to 30 fF typ).

The capacitive load as “seen” by the XTAL is across its terminals. It is named  $C_{LOADMIN}$  (for minimum value), and  $C_{LOADMAX}$  (for maximum value). These are used for calculating the pull range.

Note that the  $C_{LOAD}$  range “center” is approximately 20 pF, but we may not want a XTAL calibrated to that load. This is because the pullability is not linear, as represented in the equation below. Plotting the pullability of the XTAL shows this expected behavior as shown in Figure 7. In this example, specifying a XTAL calibrated to 16 pF load provides a balanced ppm pullability range around the nominal frequency.

**Figure 7. Frequency vs.  $C_{LOAD}$  Behavior for Example XTAL**

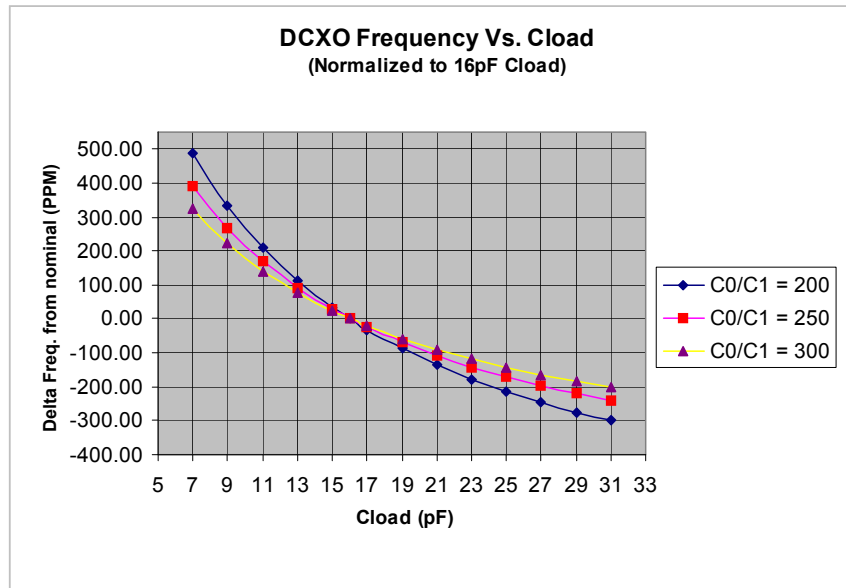



**Table 2. Pullability Range from XTAL with Different C<sub>0</sub>/C<sub>1</sub> Ratio**

C <sub>L</sub> (pF)	Calculated Pull Range in ppm, (Normalized)		
	C <sub>0</sub> /C <sub>1</sub> = 200	C <sub>0</sub> /C <sub>1</sub> = 250	C <sub>0</sub> /C <sub>1</sub> = 300
7	489.13	391.30	326.09
9	332.88	266.30	221.92
11	211.35	169.08	140.90
13	114.13	91.30	76.09
15	34.58	27.67	23.06
16	0.00	0.00	0.00
17	-31.70	-25.36	-21.14
19	-87.79	-70.23	-58.53
21	-135.87	-108.70	-90.58
23	-177.54	-142.03	-118.36
25	-213.99	-171.20	-142.66
27	-246.16	-196.93	-164.11
29	-274.76	-219.81	-183.17
31	-300.34	-240.27	-200.23

Calculated value of the pullability range for the XTAL with C<sub>0</sub>/C<sub>1</sub> ratio of 200, 250, and 300 are shown in Table 2. For this calculation C<sub>LOADMIN</sub> = 7 pF and C<sub>LOADMAX</sub> = 31 pF is used. Using a XTAL that has a nominal frequency specified at load capacitance of 16 pF, almost symmetrical pullability range is obtained.

Next, it is important to calculate the pullability range including error tolerances. This is the **capture range** of the input reference frequency that the FailSafe device and XTAL combination can reliably span.

Calculating the **capture range** involves subtracting error tolerances as follows:

<b>Parameter</b> .....	<b>f error (ppm)</b>
Manufacturing frequency tolerance .....	15
Temperature stability .....	30
Aging .....	3
Board/trace variation .....	5
<b>Total</b> .....	<b>53</b>

**Example: Capture Range for XTAL with C<sub>0</sub>/C<sub>1</sub> Ratio of 200**

**Negative Capture Range** = -300 ppm + 53 ppm = -247 ppm

**Positive Capture Range** = 489 ppm - 53 ppm = +436 ppm

It is important to note that the XTAL with lower C<sub>0</sub>/C<sub>1</sub> ratio has wider **pullability/capture range** as compared to the higher C<sub>0</sub>/C<sub>1</sub> ratio. This helps to select the appropriate XTAL for use in the FailSafe application.

**Important Notes**

Following are some important notes that should be considered when designing with the Failsafe device:

1. The trace capacitance of the XTAL inputs, XIN and XOUT must be kept as small as possible.
2. Specify the DCXO for C<sub>0</sub>/C<sub>1</sub> ratio to be less than 250 and the XTAL Load Capacitance to be approximately 16 pF. A typical DCXO specification from Ecliptek is attached here (please see page 6) for reference.
3. XTAL with low temperature frequency variation, low manufacturing frequency tolerance and low aging must be chosen.
4. Pull range must be checked for its upper and lower frequency symmetry from the nominal value as described in this application note.

## Absolute Maximum Conditions

Exceeding maximum ratings may shorten the useful life of the device. User guidelines are not tested.

Parameter	Description	Condition	Min	Max	Unit
V <sub>DD</sub>	Supply Voltage		-0.5	4.6	V
V <sub>IN</sub>	Input Voltage	Relative to V <sub>SS</sub>	-0.5	V <sub>DD</sub> + 0.5	VDC
T <sub>S</sub>	Temperature, Storage	Non Functional	-65	150	°C
T <sub>J</sub>	Temperature, Junction	Functional	-	125	°C
ESD <sub>HBM</sub>	ESD Protection (Human Body Model)	MIL-STD-883, Method 3015	2000	-	V
UL-94	Flammability Rating	At 1/8 in.	V-0		
MSL	Moisture Sensitivity Level		3		

**Multiple Supplies:** The voltage on any input or I/O pin cannot exceed the power pin during power-up. Power supply sequencing is NOT required.

## Recommended Pullable Crystal Specifications

Parameter <sup>[5]</sup>	Description	Condition	Min	Typ	Max	Unit
F <sub>NOM</sub>	Nominal crystal frequency	Parallel resonance, fundamental mode, AT cut	8.00	-	30.00	MHz
C <sub>LNOM</sub>	Nominal load capacitance		-	14	-	pF
R <sub>1</sub>	Equivalent series resistance (ESR)	Fundamental mode	-	-	25	Ω
R <sub>3</sub> /R <sub>1</sub>	Ratio of third overtone mode ESR to fundamental mode ESR	Ratio used because typical R <sub>1</sub> values are much less than the maximum spec	3	-	-	
DL	Crystal drive level	No external series resistor assumed	-	0.5	2	mW
F <sub>3SEPLI</sub>	Third overtone separation from 3 × F <sub>NOM</sub>	High side	300	-	-	ppm
F <sub>3SEPLO</sub>	Third overtone separation from 3 × F <sub>NOM</sub>	Low side	-	-	-150	ppm
C <sub>0</sub>	Crystal shunt capacitance		-	-	7	pF
C <sub>0</sub> /C <sub>1</sub>	Ratio of shunt to motional capacitance		180	-	250	
C <sub>1</sub>	Crystal motional capacitance		14.4	18	21.6	fF

## Operating Conditions

Parameter	Description	Min	Max	Unit
V <sub>DDC</sub>	3.3 V Supply Voltage	3.135	3.465	V
V <sub>DDA</sub> , V <sub>DDDB</sub>	2.5 V Supply Voltage Range	2.375	2.625	V
	3.3 V Supply Voltage Range	3.135	3.465	V
T <sub>A</sub>	Ambient Operating Temperature, Commercial	0	70	°C
	Ambient Operating Temperature, Industrial	-40	85	°C
C <sub>L</sub>	Output Load Capacitance (F <sub>out</sub> ≤ 100 MHz)	-	30	pF
	Output Load Capacitance (F <sub>out</sub> > 100 MHz)	-	15	pF
C <sub>IN</sub>	Input Capacitance (except XIN)	-	7	pF
C <sub>XIN</sub>	Crystal Input Capacitance (all internal caps off)	10	13	pF
t <sub>PU</sub>	Power up time for all VDDs to reach minimum specified voltage (power ramps must be monotonic)	0.05	500	ms

## DC Electrical Characteristics

Parameter	Description	Test Conditions	Min	Typ	Max	Unit
V <sub>IL</sub>	Input Low Voltage	CMOS Levels, 30% of V <sub>DD</sub>	-	-	0.3 × V <sub>DD</sub>	V
V <sub>IH</sub>	Input High Voltage	CMOS Levels, 70% of V <sub>DD</sub>	0.7 × V <sub>DD</sub>	-	-	V
I <sub>IL</sub>	Input Low Current	V <sub>IN</sub> = V <sub>SS</sub> (100k pull up only)	-	-	50	μA
I <sub>IH</sub>	Input High Current	V <sub>IN</sub> = V <sub>DD</sub> (100k pull down only)	-	-	50	μA
I <sub>OL</sub>	Output Low Current	V <sub>OL</sub> = 0.5 V, V <sub>DD</sub> = 2.5 V	-	18	-	mA
		V <sub>OL</sub> = 0.5 V, V <sub>DD</sub> = 3.3 V	-	20	-	mA
I <sub>OH</sub>	Output High Current	V <sub>OH</sub> = V <sub>DD</sub> - 0.5 V, V <sub>DD</sub> = 2.5 V	-	18	-	mA
		V <sub>OH</sub> = V <sub>DD</sub> - 0.5 V, V <sub>DD</sub> = 3.3 V	-	20	-	mA
I <sub>DDQ</sub>	Quiescent Current	All Inputs grounded, PLL and DCXO in bypass mode, Reference Input = 0	-	-	250	μA

## Thermal Resistance

Parameter <sup>[6]</sup>	Description	Test Conditions	28-pin SSOP	Unit
θ <sub>JA</sub>	Thermal resistance (junction to ambient)	Test conditions follow standard test methods and procedures for measuring thermal impedance, in accordance with EIA/JESD51.	65	°C/W
θ <sub>JC</sub>	Thermal resistance (junction to case)		30	°C/W

### Notes

- Ecliptek crystals ECX-5788-13.500M, ECX-5807-19.440M, ECX-5872-19.53125M, ECX-6362-18.432M, ECX-5808-27.000M, ECX-5884-17.664M, ECX-5883-16.384M, ECX-5882-19.200M, ECX-5880-24.576M meet these specifications.
- These parameters are guaranteed by design and are not tested.

## Switching Characteristics

Parameter <sup>[7]</sup>	Description	Test Conditions	Min	Typ	Max	Unit
f <sub>REF</sub>	Reference Frequency	Commercial Grade	1.04	–	200	MHz
		Industrial Grade	1.04	–	166.7	MHz
f <sub>OUT</sub>	Output Frequency	15 pF Load, Commercial Grade	1.70	–	200	MHz
		15 pF Load, Industrial Grade	1.70	–	166.7	MHz
f <sub>XIN</sub>	DCXO Frequency		8.0	–	30	MHz
t <sub>DC</sub>	Duty Cycle	Measured at V <sub>DD</sub> /2	47	–	53	%
t <sub>SR(I)</sub>	Input Slew Rate	Measured on REF1 Input, 30% to 70% of V <sub>DD</sub>	0.5	–	4.0	V/ns
t <sub>SR(O)</sub>	Output Slew Rate	Measured from 20% to 80% of V <sub>DD</sub> = 3.3 V, 15 pF Load	0.8	–	4.0	V/ns
		Measured from 20% to 80% of V <sub>DD</sub> = 2.5V, 15 pF Load	0.4	–	3.0	V/ns
t <sub>SK(O)</sub>	Output to Output Skew	All outputs equally loaded, measured at V <sub>DD</sub> /2	–	110	200	ps
t <sub>SK(IB)</sub>	Intrabank Skew	All outputs equally loaded, measured at V <sub>DD</sub> /2	–	–	75	ps
t <sub>SK(PP)</sub>	Part to Part Skew	Measured at V <sub>DD</sub> /2	–	–	500	ps
t <sub>(φ)</sub> <sup>[8]</sup>	Static Phase Offset	Measured at V <sub>DD</sub> /2	–	–	250	ps
t <sub>D(φ)</sub> <sup>[8]</sup>	Dynamic Phase Offset	Measured at V <sub>DD</sub> /2	–	–	500	ps
t <sub>J(CC)</sub>	Cycle-to-Cycle Jitter	Load = 15 pF, f <sub>OUT</sub> ≥ 6.25 MHz	–	100	200	ps
			–	18	35	ps <sub>RMS</sub>
t <sub>LOCK</sub>	Lock Time	At room temperature with 18.432 MHz Crystal	–	70	–	ms

### Notes

7. Parameters guaranteed by design and characterization, not 100% tested in production.

8. The t<sub>(φ)</sub> reference feedback input delay is guaranteed for a maximum 4:1 input edge ratio between the two signals as long as t<sub>SR(I)</sub> is maintained.

## Switching Waveforms

Figure 8. Duty Cycle

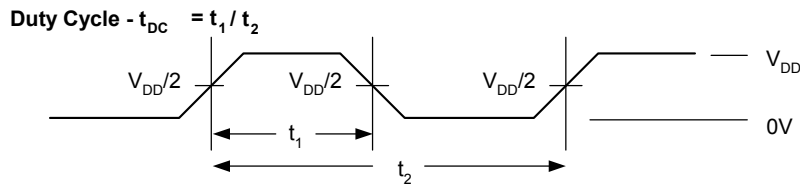

Figure 9. Input Slew Rate

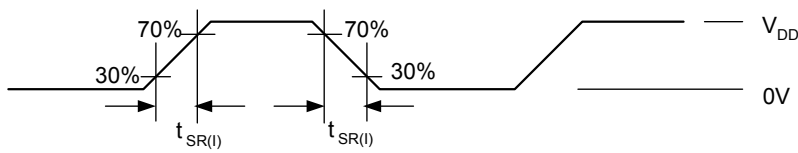

Figure 10. Output Slew Rate

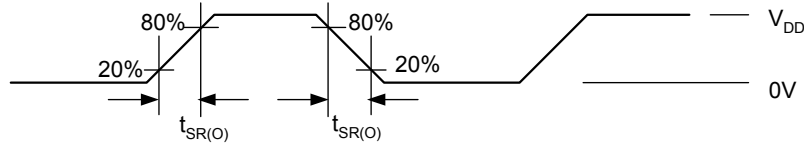

Figure 11. Output to Output Skew and IntraBank Skew

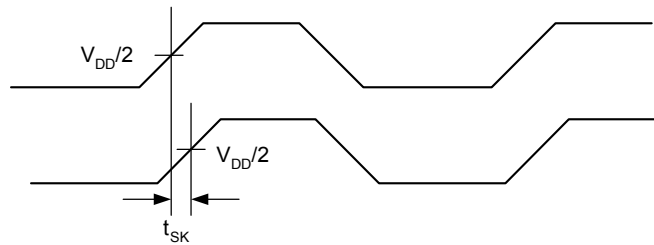
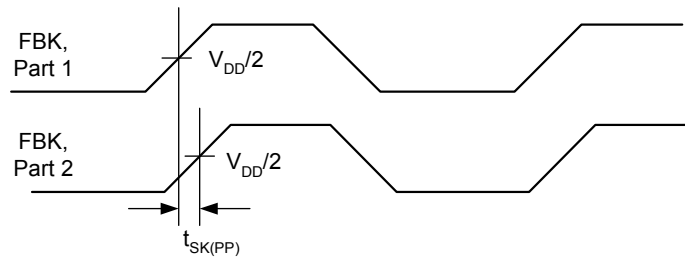
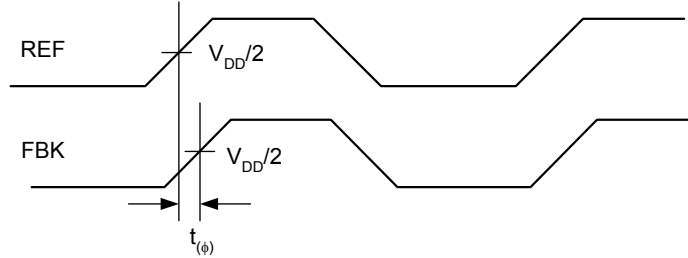

Figure 12. Part to Part Skew



**Switching Waveforms** (continued)

**Figure 13. Phase Offset**



**Ordering Information**

Part Number	Package Type	Product Flow
<b>Pb-free</b>		
CY23FS08OXI	28-pin SSOP	Industrial, -40 °C to 85 °C
CY23FS08OXIT	28-pin SSOP – Tape and Reel	Industrial, -40 °C to 85 °C
CY23FS08OXC	28-pin SSOP	Commercial, 0 °C to 70 °C
CY23FS08OXCT	28-pin SSOP – Tape and Reel	Commercial, 0 °C to 70 °C

**Ordering Code Definitions**

CY 23FS08 O X X - X

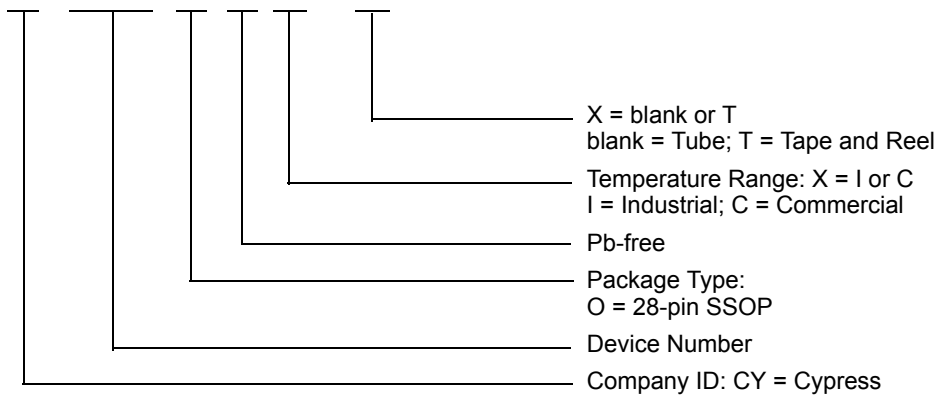

Package Diagram

Figure 14. 28-pin SSOP (210 Mils) Package Outline, 51-85079

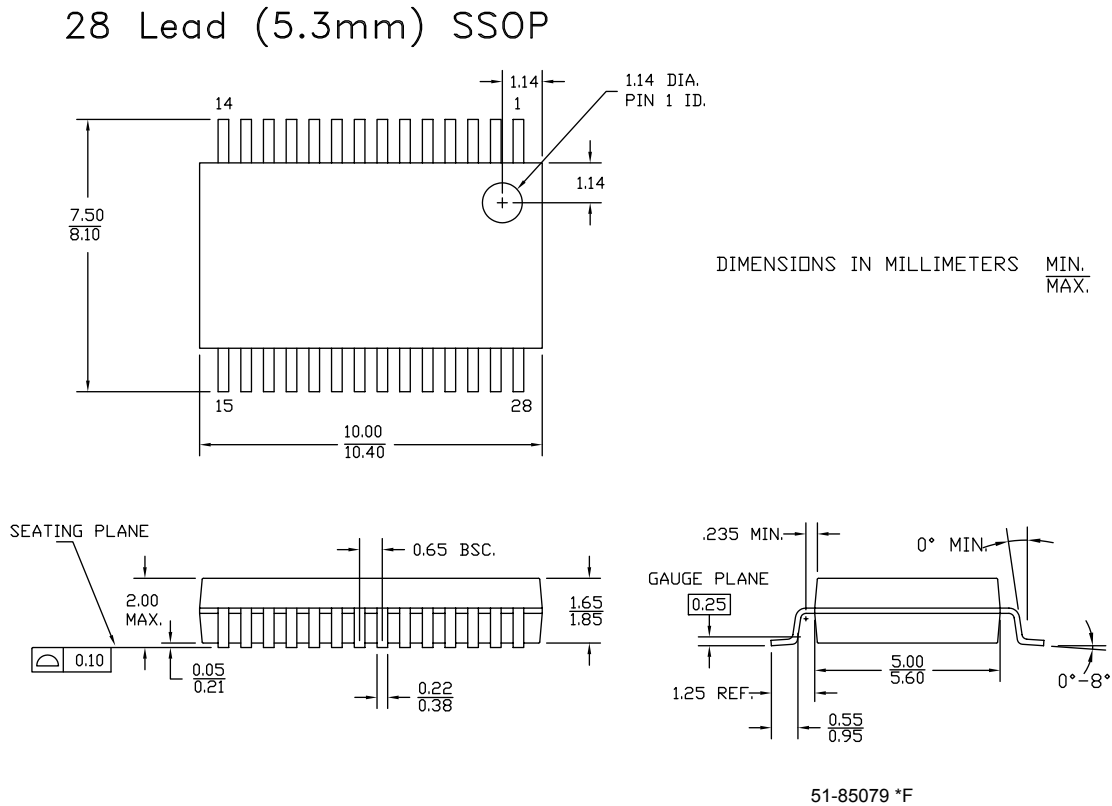

## Acronyms

Acronym	Description
DCXO	Digitally Controlled Crystal Oscillator
ESD	Electrostatic Discharge
PLL	Phase Locked Loop
RMS	Root Mean Square
SSOP	Shrunk Small Outline Package
XTAL	Crystal

## Document Conventions

### Units of Measure

Symbol	Unit of Measure
°C	degree Celsius
MHz	megahertz
μA	microampere
mA	milliampere
ms	millisecond
ns	nanosecond
Ω	ohm
ppm	parts per million
pF	picofarad
ps	picosecond
W	watt
V	volt



Document History Page

Document Title: CY23FS08, Failsafe™ 2.5 V/3.3 V Zero Delay Buffer Document Number: 38-07518				
Revision	ECN	Submission Date	Orig. of Change	Description of Change
**	123699	04/23/03	RGL	New data sheet
*A	224067	See ECN	RGL / ZJX	Changed the XTAL Specifications table.
*B	276749	See ECN	RGL	Removed (T <sub>LOCK</sub> ) Lock Time Specification.
*C	417645	See ECN	RGL	Added Lead-free devices Added typical nos. on jitters
*D	2865396	01/25/2010	KVM	Remove figures showing dynamic response to 180° phase change to REF Add waveforms for input slew rate and intrabank skew Change “CI” to “C <sub>LOAD</sub> ” Absolute Maximum Conditions table: remove duplicate T <sub>A</sub> parameter Replace crystal ECX–5806–18.432M with ECX–6362–18.432M Remove obsolete part numbers CY23FS08OI, CY23FS08OIT, CY23FS08OC and CY23FS08OCT Replace “Lead-free” with “Pb-free” Remove unreferenced footnote 9 Change package drawing title from “O28” to “SP28”, updated package diagram Added Table of Contents
*E	2925613	04/30/10	KVM	Posting to external web.
*F	3130032	01/06/2011	BASH	Changed t <sub>D(φ)</sub> max value from 200 to 500 and removed t <sub>D(φ)</sub> Typical value in <a href="#">Switching Characteristics</a> on page 11. Added <a href="#">Ordering Code Definitions</a> . Added <a href="#">Acronyms and Units of Measure</a> .
*G	3695670	08/03/2012	PURU	Updated <a href="#">XTAL Selection Criteria and Application Example</a> : Updated <a href="#">Figure 7</a> . Updated <a href="#">Table 2</a> . Updated <a href="#">Package Diagram</a> : Revised spec 51-85079 to *E.
*H	4276658	02/10/2014	CINM	Updated to new template. Completing Sunset Review.
*I	4580588	12/05/2014	AJU	Updated <a href="#">Functional Description</a> : Added “For a complete list of related documentation, click <a href="#">here</a> .” at the end.
*J	5275836	05/27/2016	PSR	Updated <a href="#">Absolute Maximum Conditions</a> : Removed $\theta_{JC}$ , $\theta_{JA}$ parameters and their details. Changed value of MSL parameter from “1” to “3”. Added <a href="#">Thermal Resistance</a> . Updated <a href="#">Package Diagram</a> : spec 51-85079 – Changed revision from *E to *F. Updated to new template.

## Sales, Solutions, and Legal Information

### Worldwide Sales and Design Support

Cypress maintains a worldwide network of offices, solution centers, manufacturer's representatives, and distributors. To find the office closest to you, visit us at [Cypress Locations](#).

#### Products

ARM® Cortex® Microcontrollers	<a href="http://cypress.com/arm">cypress.com/arm</a>
Automotive	<a href="http://cypress.com/automotive">cypress.com/automotive</a>
Clocks & Buffers	<a href="http://cypress.com/clocks">cypress.com/clocks</a>
Interface	<a href="http://cypress.com/interface">cypress.com/interface</a>
Lighting & Power Control	<a href="http://cypress.com/powerpsoc">cypress.com/powerpsoc</a>
Memory	<a href="http://cypress.com/memory">cypress.com/memory</a>
PSoC	<a href="http://cypress.com/psoc">cypress.com/psoc</a>
Touch Sensing	<a href="http://cypress.com/touch">cypress.com/touch</a>
USB Controllers	<a href="http://cypress.com/usb">cypress.com/usb</a>
Wireless/RF	<a href="http://cypress.com/wireless">cypress.com/wireless</a>

#### PSoC® Solutions

[PSoC 1](#) | [PSoC 3](#) | [PSoC 4](#) | [PSoC 5LP](#)

#### Cypress Developer Community

[Forums](#) | [Projects](#) | [Video](#) | [Blogs](#) | [Training](#) | [Components](#)

#### Technical Support

[cypress.com/support](http://cypress.com/support)

---

© Cypress Semiconductor Corporation, 2003-2016. This document is the property of Cypress Semiconductor Corporation and its subsidiaries, including Spansion LLC ("Cypress"). This document, including any software or firmware included or referenced in this document ("Software"), is owned by Cypress under the intellectual property laws and treaties of the United States and other countries worldwide. Cypress reserves all rights under such laws and treaties and does not, except as specifically stated in this paragraph, grant any license under its patents, copyrights, trademarks, or other intellectual property rights. If the Software is not accompanied by a license agreement and you do not otherwise have a written agreement with Cypress governing the use of the Software, then Cypress hereby grants you a personal, non-exclusive, nontransferable license (without the right to sublicense) (1) under its copyright rights in the Software (a) for Software provided in source code form, to modify and reproduce the Software solely for use with Cypress hardware products, only internally within your organization, and (b) to distribute the Software in binary code form externally to end users (either directly or indirectly through resellers and distributors), solely for use on Cypress hardware product units, and (2) under those claims of Cypress's patents that are infringed by the Software (as provided by Cypress, unmodified) to make, use, distribute, and import the Software solely for use with Cypress hardware products. Any other use, reproduction, modification, translation, or compilation of the Software is prohibited.

TO THE EXTENT PERMITTED BY APPLICABLE LAW, CYPRESS MAKES NO WARRANTY OF ANY KIND, EXPRESS OR IMPLIED, WITH REGARD TO THIS DOCUMENT OR ANY SOFTWARE OR ACCOMPANYING HARDWARE, INCLUDING, BUT NOT LIMITED TO, THE IMPLIED WARRANTIES OF MERCHANTABILITY AND FITNESS FOR A PARTICULAR PURPOSE. To the extent permitted by applicable law, Cypress reserves the right to make changes to this document without further notice. Cypress does not assume any liability arising out of the application or use of any product or circuit described in this document. Any information provided in this document, including any sample design information or programming code, is provided only for reference purposes. It is the responsibility of the user of this document to properly design, program, and test the functionality and safety of any application made of this information and any resulting product. Cypress products are not designed, intended, or authorized for use as critical components in systems designed or intended for the operation of weapons, weapons systems, nuclear installations, life-support devices or systems, other medical devices or systems (including resuscitation equipment and surgical implants), pollution control or hazardous substances management, or other uses where the failure of the device or system could cause personal injury, death, or property damage ("Unintended Uses"). A critical component is any component of a device or system whose failure to perform can be reasonably expected to cause the failure of the device or system, or to affect its safety or effectiveness. Cypress is not liable, in whole or in part, and you shall and hereby do release Cypress from any claim, damage, or other liability arising from or related to all Unintended Uses of Cypress products. You shall indemnify and hold Cypress harmless from and against all claims, costs, damages, and other liabilities, including claims for personal injury or death, arising from or related to any Unintended Uses of Cypress products.

Cypress, the Cypress logo, Spansion, the Spansion logo, and combinations thereof, PSoC, CapSense, EZ-USB, F-RAM, and Traveo are trademarks or registered trademarks of Cypress in the United States and other countries. For a more complete list of Cypress trademarks, visit [cypress.com](http://cypress.com). Other names and brands may be claimed as property of their respective owners.