



Chipsmall Limited consists of a professional team with an average of over 10 year of expertise in the distribution of electronic components. Based in Hongkong, we have already established firm and mutual-benefit business relationships with customers from,Europe,America and south Asia,supplying obsolete and hard-to-find components to meet their specific needs.

With the principle of “Quality Parts,Customers Priority,Honest Operation,and Considerate Service”,our business mainly focus on the distribution of electronic components. Line cards we deal with include Microchip,ALPS,ROHM,Xilinx,Pulse,ON,Everlight and Freescale. Main products comprise IC,Modules,Potentiometer,IC Socket,Relay,Connector.Our parts cover such applications as commercial,industrial, and automotives areas.

We are looking forward to setting up business relationship with you and hope to provide you with the best service and solution. Let us make a better world for our industry!



Contact us

Tel: +86-755-8981 8866 Fax: +86-755-8427 6832

Email & Skype: info@chipsmall.com Web: www.chipsmall.com

Address: A1208, Overseas Decoration Building, #122 Zhenhua RD., Futian, Shenzhen, China



CZRFR52C2-HF Thru CZRFR52C39-HF

Voltage 2 to 39 Volts

Power 200 mWatts

RoHS Device

Halogen Free

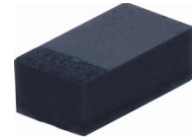

Features

- 200mW Power Dissipation.
- High Voltages from 2 ~ 39 V.
- Designed for mounting on small surface.
- Extremely thin/leadless package.
- Pb free product.

Mechanical data

- Case: 1005/SOD-323F Standard package
Molded plastic.
- Terminals: Gold plated, solderable per MIL-STD-750,method 2026.
- Polarity: Indicated by cathode band.
- Weight: 0.006 gram(approx.).

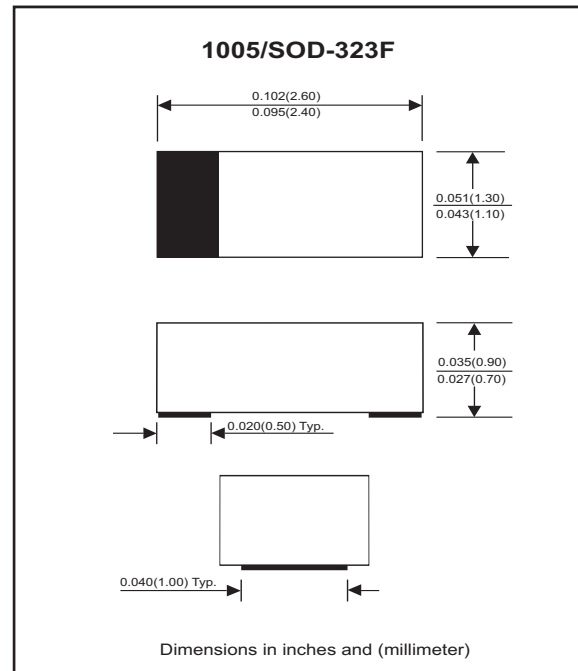

Maximum Rating AND Electrical Characteristics

| Parameter | Symbol | Value | Unit |
|---|-----------|-------------|------------------|
| Maximum Forward Voltage Drop at $I_F = 10 \text{ mA}$ | V_F | 0.9 | V |
| Maximum Power Dissipation at 25 C° | P_D | 200 | mW |
| Forward current , surge peak 8.3 ms single half sine-wave superimposed on rate load(JEDEC method) | I_{FSM} | 2.0 | A |
| Peak ESD voltage capability (IEC 61000-4-2) | V_{PV} | 8 | kV |
| Operating Junction and Storage Temperature Range | T_J | -55 to +125 | $^\circ\text{C}$ |

Electrical Characteristics (TA=25 °C)

| Part Number | Marking Code | Zener Voltage | | | Operating resistance | | Rising operating Resistance | | Reverse current | |
|----------------|--------------|--------------------|-------|---------------------|----------------------|---------------------|-----------------------------|---------------------|-----------------|--------------------|
| | | V _Z (V) | | | ZZT(Ohm) | | ZZK(Ohm) | | IR(uA) | |
| | | Min | Max | I _Z (mA) | Max | I _Z (mA) | Max | I _Z (mA) | Max | V _R (V) |
| CZRFR52C2-HF | Z0 | 1.90 | 2.10 | 5 | 100 | 5 | 600 | 1 | 100 | 1 |
| CZRFR52C2V2-HF | Z1 | 2.09 | 2.31 | 5 | 100 | 5 | 600 | 1 | 100 | 1 |
| CZRFR52C2V4-HF | Z2 | 2.28 | 2.52 | 5 | 85 | 5 | 600 | 1 | 100 | 1 |
| CZRFR52C2V7-HF | Z3 | 2.57 | 2.84 | 5 | 83 | 5 | 500 | 1 | 75 | 1 |
| CZRFR52C3-HF | Z4 | 2.85 | 3.15 | 5 | 95 | 5 | 500 | 1 | 50 | 1 |
| CZRFR52C3V3-HF | Z5 | 3.14 | 3.47 | 5 | 95 | 5 | 500 | 1 | 25 | 1 |
| CZRFR52C3V6-HF | Z6 | 3.42 | 3.78 | 5 | 95 | 5 | 500 | 1 | 15 | 1 |
| CZRFR52C3V9-HF | Z7 | 3.71 | 4.10 | 5 | 95 | 5 | 500 | 1 | 10 | 1 |
| CZRFR52C4V3-HF | Z8 | 4.09 | 4.52 | 5 | 95 | 5 | 500 | 1 | 5 | 1 |
| CZRFR52C4V7-HF | Z9 | 4.47 | 4.94 | 5 | 78 | 5 | 500 | 1 | 5 | 2 |
| CZRFR52C5V1-HF | ZA | 4.85 | 5.36 | 5 | 60 | 5 | 480 | 1 | 0.1 | 0.8 |
| CZRFR52C5V6-HF | ZB | 5.32 | 5.88 | 5 | 40 | 5 | 400 | 1 | 0.1 | 1 |
| CZRFR52C6V2-HF | ZC | 5.89 | 6.51 | 5 | 10 | 5 | 200 | 1 | 0.1 | 2 |
| CZRFR52C6V8-HF | ZE | 6.46 | 7.14 | 5 | 8 | 5 | 150 | 1 | 0.1 | 3 |
| CZRFR52C7V5-HF | ZF | 7.13 | 7.88 | 5 | 7 | 5 | 50 | 1 | 0.1 | 5 |
| CZRFR52C8V2-HF | ZG | 7.79 | 8.61 | 5 | 7 | 5 | 50 | 1 | 0.1 | 6 |
| CZRFR52C9V1-HF | ZH | 8.65 | 9.56 | 5 | 10 | 5 | 50 | 1 | 0.1 | 7 |
| CZRFR52C10-HF | ZJ | 9.50 | 10.50 | 5 | 15 | 5 | 70 | 1 | 0.1 | 7.5 |
| CZRFR52C11-HF | ZK | 10.45 | 11.55 | 5 | 20 | 5 | 70 | 1 | 0.1 | 8.5 |
| CZRFR52C12-HF | ZM | 11.40 | 12.60 | 5 | 20 | 5 | 90 | 1 | 0.1 | 9 |
| CZRFR52C13-HF | ZN | 12.35 | 13.65 | 5 | 25 | 5 | 110 | 1 | 0.1 | 10 |
| CZRFR52C15-HF | ZP | 14.25 | 15.75 | 5 | 30 | 5 | 110 | 1 | 0.1 | 11 |
| CZRFR52C16-HF | ZQ | 15.20 | 16.80 | 5 | 40 | 5 | 170 | 1 | 0.1 | 12 |
| CZRFR52C18-HF | ZR | 17.10 | 18.90 | 5 | 50 | 5 | 170 | 1 | 0.1 | 14 |
| CZRFR52C20-HF | ZS | 19.00 | 21.00 | 5 | 50 | 5 | 220 | 1 | 0.1 | 15 |
| CZRFR52C22-HF | ZT | 20.90 | 23.10 | 5 | 55 | 5 | 220 | 1 | 0.1 | 17 |
| CZRFR52C24-HF | ZU | 22.80 | 25.20 | 5 | 80 | 5 | 220 | 1 | 0.1 | 18 |
| CZRFR52C27-HF | ZV | 25.65 | 28.35 | 5 | 80 | 5 | 250 | 1 | 0.1 | 20 |
| CZRFR52C30-HF | ZW | 28.50 | 31.50 | 5 | 80 | 5 | 250 | 1 | 0.1 | 23 |
| CZRFR52C33-HF | ZX | 31.35 | 34.65 | 5 | 80 | 5 | 250 | 1 | 0.1 | 25 |
| CZRFR52C36-HF | ZY | 34.20 | 37.80 | 5 | 90 | 5 | 250 | 1 | 0.1 | 27 |
| CZRFR52C39-HF | ZZ | 37.05 | 40.95 | 5 | 90 | 5 | 300 | 1 | 0.1 | 29 |

RATING AND CHARACTERISTIC CURVES (CZRFR52C2-HF Thru CZRFR52C39-HF)

Fig.1 TEMPERATURE COEFFICIENTS

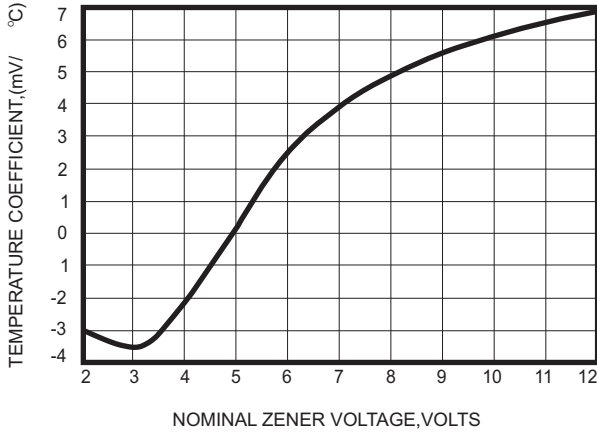

Fig.2 TEMPERATURE COEFFICIENTS

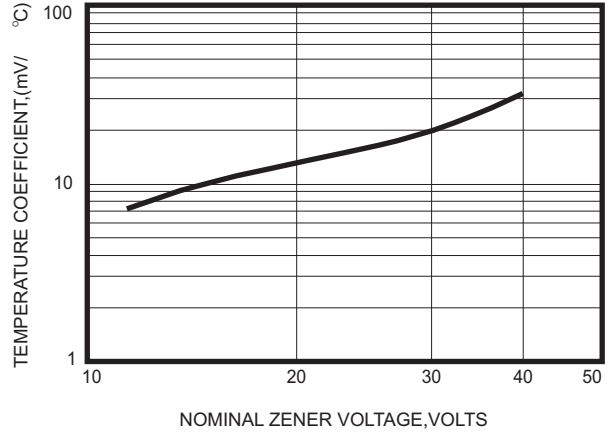

Fig.3 EFFECT OF ZENER VOLTAGE ON ZENER IMPEDANCE

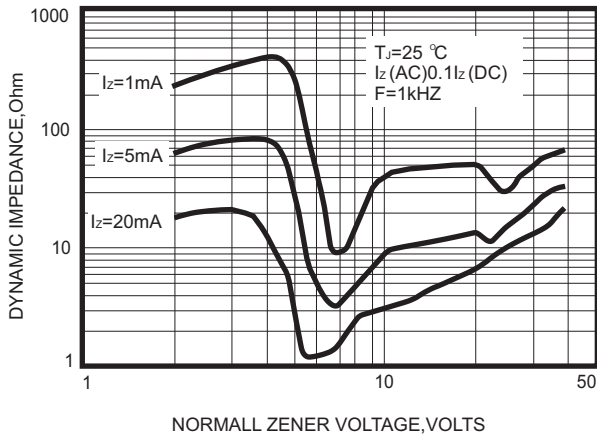

Fig.4 TYPICAL FORWARD VOLTAGE

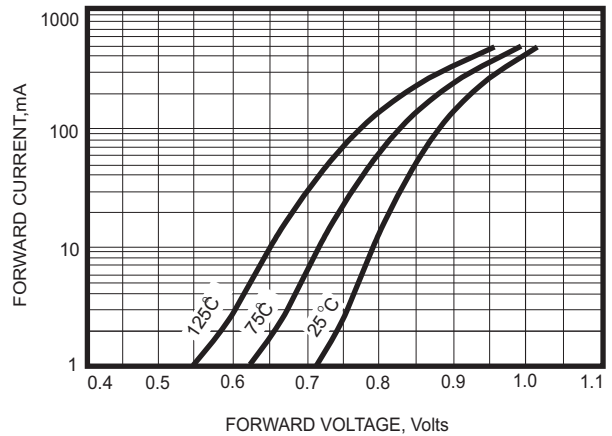

Fig.5 TYPICAL LEAKAGE CURRENT

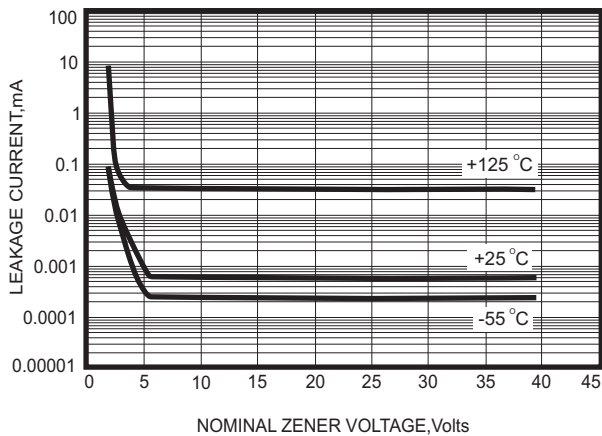
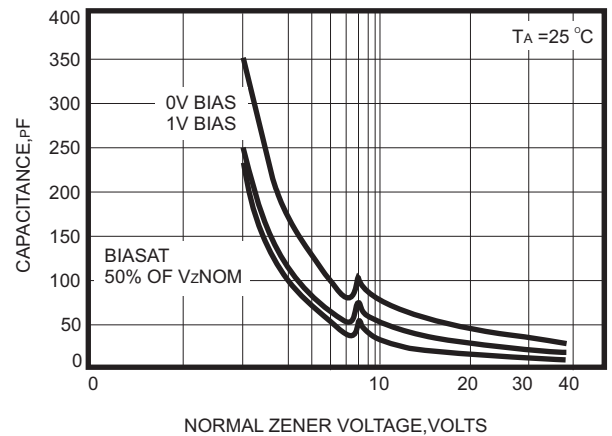

Fig.6 TYPICAL CAPACITANCE



RATING AND CHARACTERISTIC CURVES (CZRFR52C2-HF Thru CZRFR52C39-HF)

Fig.7 ZENER VOLTAGE VERSUS ZENER CURRENT

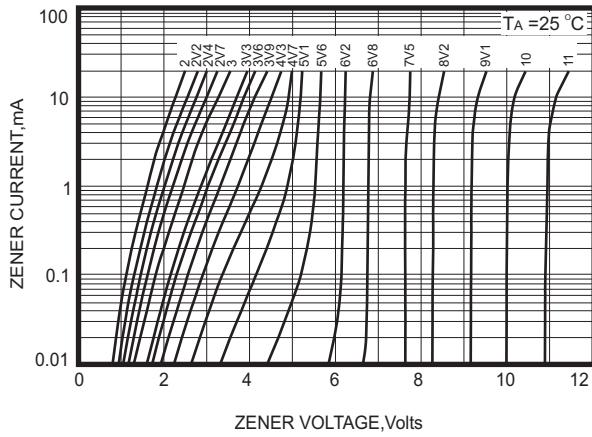

Fig.8 ZENER VOLTAGE VERSUS ZENER CURRENT

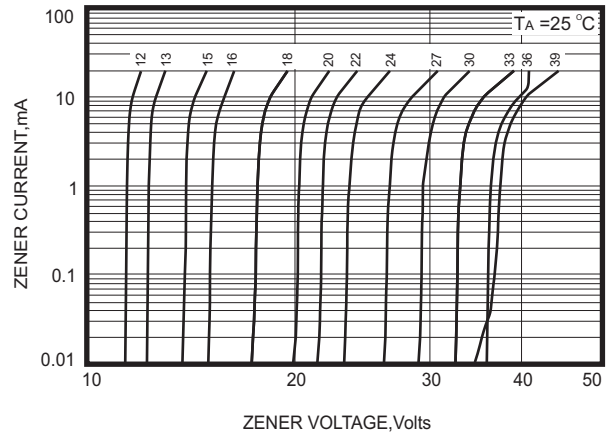
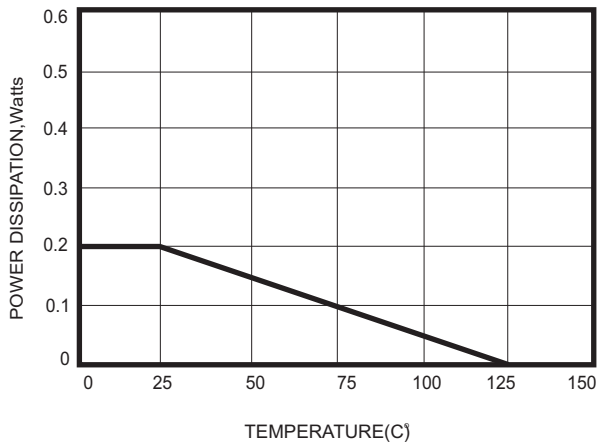
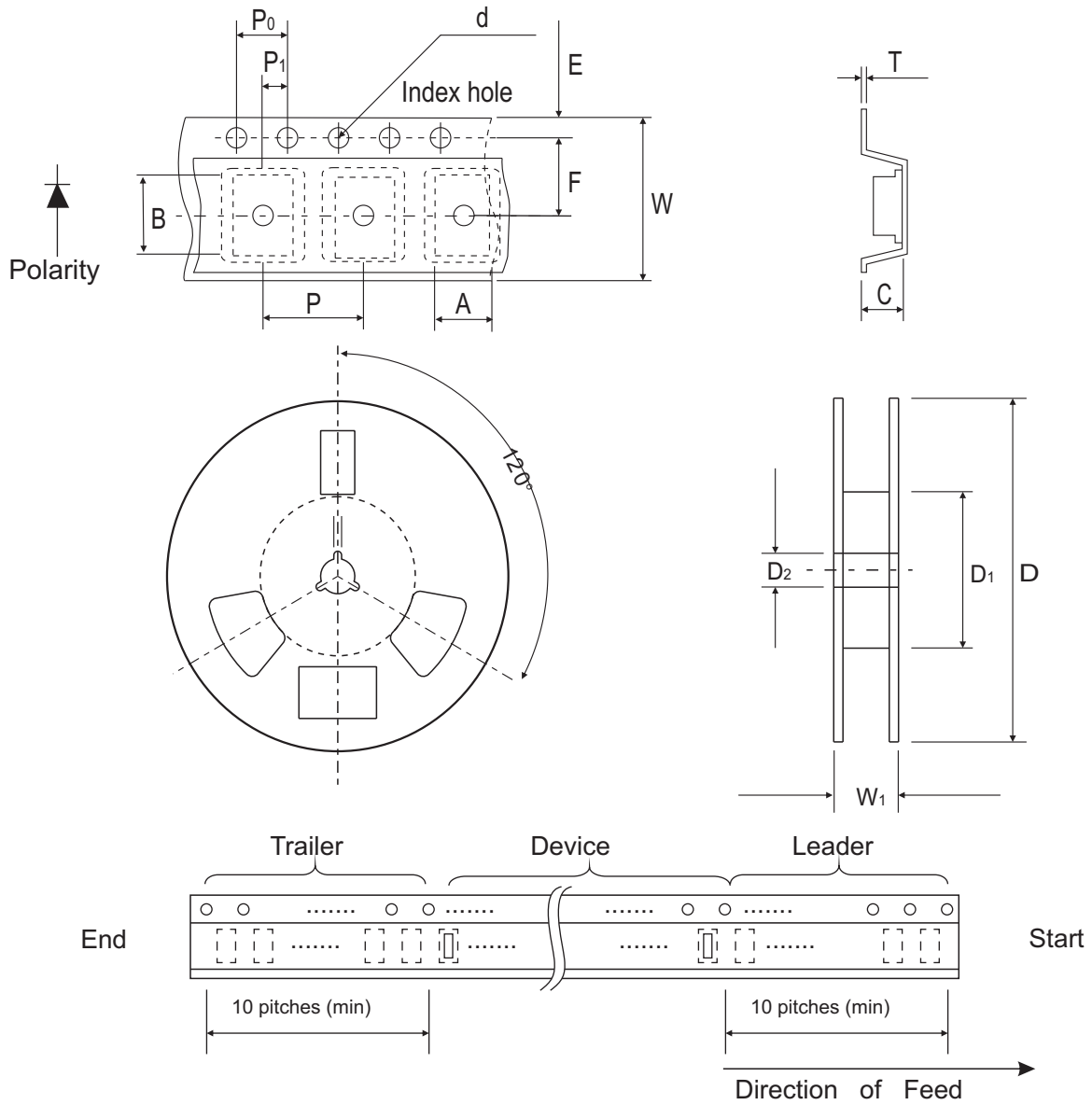

Fig.9 STEADY STATE POWER DERATING



Reel Taping Specification



| 1005 (SOD-323F) | SYMBOL | A | B | C | d | D | D ₁ | D ₂ |
|--------------------|--------|---------------|---------------|---------------|---------------|--------------|----------------|----------------|
| | (mm) | 1.55 ± 0.10 | 2.65 ± 0.10 | 1.05 ± 0.10 | 1.55 ± 0.05 | 178 ± 1 | 60.0 MIN. | 13.0 ± 0.20 |
| | (inch) | 0.061 ± 0.004 | 0.104 ± 0.004 | 0.041 ± 0.004 | 0.061 ± 0.002 | 7.008 ± 0.04 | 2.362 MIN. | 0.512 ± 0.008 |

| 1005 (SOD-323F) | SYMBOL | E | F | P | P ₀ | P ₁ | T | W | W ₁ |
|--------------------|--------|---------------|---------------|---------------|----------------|----------------|---------------|---------------|----------------|
| | (mm) | 1.75 ± 0.10 | 3.50 ± 0.05 | 4.00 ± 0.10 | 4.00 ± 0.10 | 2.00 ± 0.05 | 0.23 ± 0.05 | 8.00 ± 0.20 | 13.5 MAX. |
| | (inch) | 0.069 ± 0.004 | 0.138 ± 0.002 | 0.157 ± 0.004 | 0.157 ± 0.004 | 0.079 ± 0.004 | 0.009 ± 0.002 | 0.315 ± 0.008 | 0.531 MAX. |

Suggested PAD Layout

| SIZE | 1005/SOD-323F | |
|------|---------------|--------|
| | (mm) | (inch) |
| A | 2.00 | 0.079 |
| B | 0.70 | 0.028 |
| C | 1.30 | 0.051 |
| D | 2.70 | 0.106 |
| E | 1.30 | 0.051 |

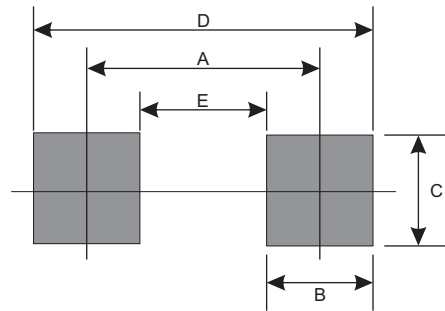

Standard Package

| Case Type | Qty per Reel | Reel Size |
|---------------|--------------|-----------|
| | (Pcs) | (inch) |
| 1005/SOD-323F | 4000 | 7 |