



Chipsmall Limited consists of a professional team with an average of over 10 year of expertise in the distribution of electronic components. Based in Hongkong, we have already established firm and mutual-benefit business relationships with customers from,Europe,America and south Asia,supplying obsolete and hard-to-find components to meet their specific needs.

With the principle of “Quality Parts,Customers Priority,Honest Operation,and Considerate Service”,our business mainly focus on the distribution of electronic components. Line cards we deal with include Microchip,ALPS,ROHM,Xilinx,Pulse,ON,Everlight and Freescale. Main products comprise IC,Modules,Potentiometer,IC Socket,Relay,Connector.Our parts cover such applications as commercial,industrial, and automotives areas.

We are looking forward to setting up business relationship with you and hope to provide you with the best service and solution. Let us make a better world for our industry!



## Contact us

Tel: +86-755-8981 8866 Fax: +86-755-8427 6832

Email & Skype: info@chipsmall.com Web: www.chipsmall.com

Address: A1208, Overseas Decoration Building, #122 Zhenhua RD., Futian, Shenzhen, China



CZSH5-40

**SURFACE MOUNT SILICON  
SCHOTTKY RECTIFIER  
5.0 AMP, 40 VOLT**



**SOT-223 CASE**



[www.centralemi.com](http://www.centralemi.com)

**DESCRIPTION:**

The CENTRAL SEMICONDUCTOR 5.0 Amp, SOT-223 surface mount silicon Schottky rectifier, is designed for use in all types of commercial, industrial, entertainment, computer and automotive applications, which require a high current device.

**MARKING: FULL PART NUMBER**

<b>MAXIMUM RATINGS:</b> ( $T_A=25^\circ\text{C}$ unless otherwise noted)	<b>SYMBOL</b>		<b>UNITS</b>
Peak Repetitive Reverse Voltage	$V_{RRM}$	40	V
DC Blocking Voltage	$V_R$	40	V
RMS Reverse Voltage	$V_{R(RMS)}$	28	V
Average Forward Current ( $T_A=75^\circ\text{C}$ )	$I_O$	5.0	A
Peak Forward Surge Current, $t_p=8.3\text{ms}$	$I_{FSM}$	125	A
Operating and Storage Junction Temperature	$T_J, T_{stg}$	-65 to +150	$^\circ\text{C}$

**ELECTRICAL CHARACTERISTICS:** ( $T_A=25^\circ\text{C}$  unless otherwise noted)

<b>SYMBOL</b>	<b>TEST CONDITIONS</b>	<b>MAX</b>	<b>UNITS</b>
$I_R$	$V_R=40\text{V}$	3.0	mA
$I_R$	$V_R=40\text{V}, T_A=100^\circ\text{C}$	20	mA
$V_F$	$I_F=5.0\text{A}$	0.55	V

CZSH5-40

**SURFACE MOUNT SILICON  
SCHOTTKY RECTIFIER  
5.0 AMP, 40 VOLT**



**SOT-223 CASE - MECHANICAL OUTLINE**

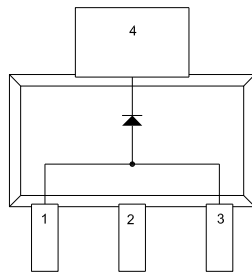
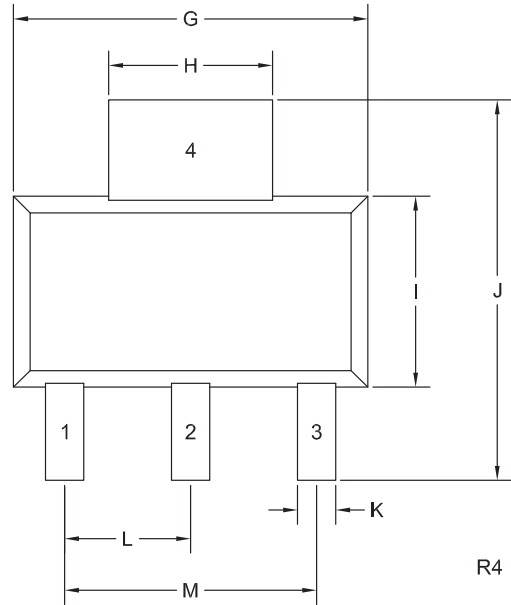
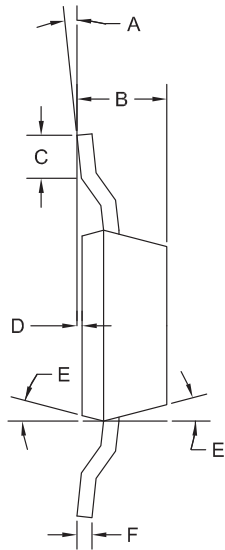

**LEAD CODE:**

- 1) Anode
  - 2) Cathode
  - 3) Anode
  - 4) Cathode
- Pin 1 and Pin 3 are common.  
Pin 2 and Pin 4 are common.

SYMBOL	INCHES		MILLIMETERS	
	MIN	MAX	MIN	MAX
A	0°	10°	0°	10°
B	0.059	0.071	1.50	1.80
C	0.018	---	0.45	---
D	0.000	0.004	0.00	0.10
E	10°		10°	
F	0.009	0.014	0.23	0.35
G	0.248	0.264	6.30	6.70
H	0.114	0.122	2.90	3.10
I	0.130	0.146	3.30	3.70
J	0.264	0.287	6.70	7.30
K	0.024	0.033	0.60	0.85
L	0.091		2.30	
M	0.181		4.60	

SOT-223 (REV: R4)

**MARKING: FULL PART NUMBER**

R6 (4-August 2017)

CZSH5-40

SURFACE MOUNT SILICON  
SCHOTTKY RECTIFIER  
5.0 AMP, 40 VOLT



TYPICAL ELECTRICAL CHARACTERISTICS

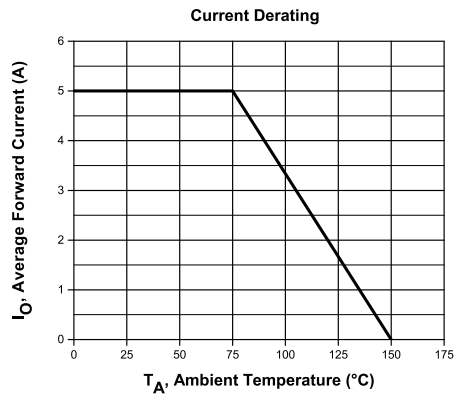
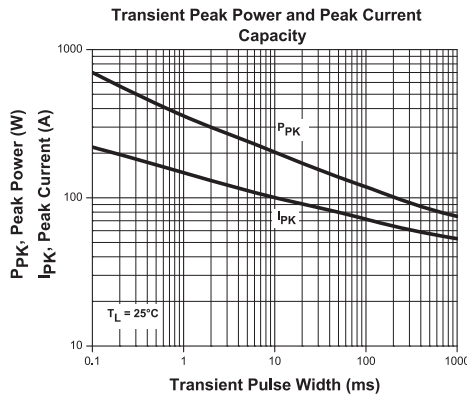
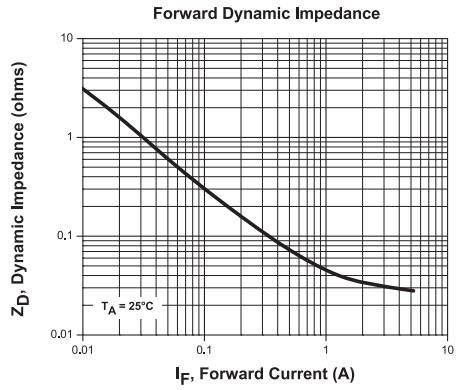
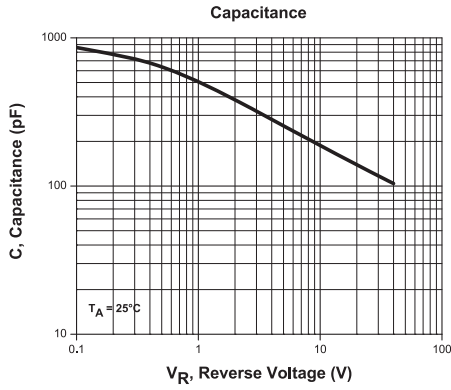
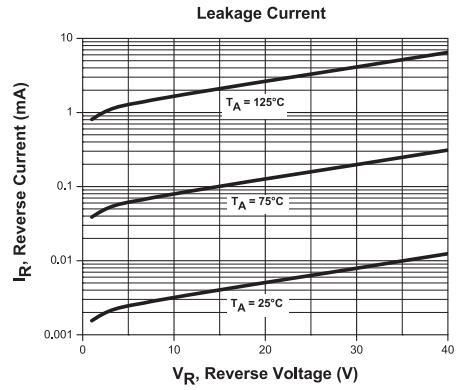
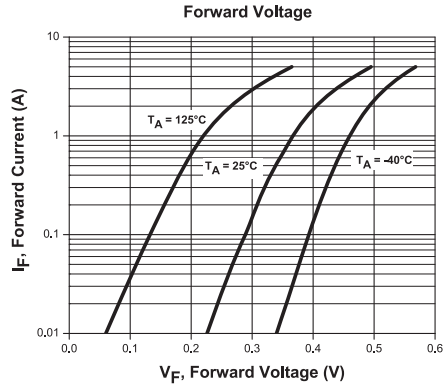

R6 (4-August 2017)

## OUTSTANDING SUPPORT AND SUPERIOR SERVICES



---

### PRODUCT SUPPORT

Central's operations team provides the highest level of support to insure product is delivered on-time.

- Supply management (Customer portals)
- Inventory bonding
- Consolidated shipping options
- Custom bar coding for shipments
- Custom product packing

---

### DESIGNER SUPPORT/SERVICES

Central's applications engineering team is ready to discuss your design challenges. Just ask.

- Free quick ship samples (2<sup>nd</sup> day air)
- Online technical data and parametric search
- SPICE models
- Custom electrical curves
- Environmental regulation compliance
- Customer specific screening
- Up-screening capabilities
- Special wafer diffusions
- PbSn plating options
- Package details
- Application notes
- Application and design sample kits
- Custom product and package development

---

### REQUESTING PRODUCT PLATING

1. If requesting Tin/Lead plated devices, add the suffix "TIN/LEAD" to the part number when ordering (example: 2N2222A TIN/LEAD).
2. If requesting Lead (Pb) Free plated devices, add the suffix "PBFREE" to the part number when ordering (example: 2N2222A PBFREE).

---

### CONTACT US

#### Corporate Headquarters & Customer Support Team

Central Semiconductor Corp.  
145 Adams Avenue  
Hauppauge, NY 11788 USA  
Main Tel: (631) 435-1110  
Main Fax: (631) 435-1824  
Support Team Fax: (631) 435-3388  
[www.centrasemi.com](http://www.centrasemi.com)

**Worldwide Field Representatives:**  
[www.centrasemi.com/wwreps](http://www.centrasemi.com/wwreps)

**Worldwide Distributors:**  
[www.centrasemi.com/wwdistributors](http://www.centrasemi.com/wwdistributors)

---

For the latest version of Central Semiconductor's **LIMITATIONS AND DAMAGES DISCLAIMER**, which is part of Central's Standard Terms and Conditions of sale, visit: [www.centrasemi.com/terms](http://www.centrasemi.com/terms)