



Chipsmall Limited consists of a professional team with an average of over 10 year of expertise in the distribution of electronic components. Based in Hongkong, we have already established firm and mutual-benefit business relationships with customers from,Europe,America and south Asia,supplying obsolete and hard-to-find components to meet their specific needs.

With the principle of “Quality Parts,Customers Priority,Honest Operation,and Considerate Service”,our business mainly focus on the distribution of electronic components. Line cards we deal with include Microchip,ALPS,ROHM,Xilinx,Pulse,ON,Everlight and Freescale. Main products comprise IC,Modules,Potentiometer,IC Socket,Relay,Connector.Our parts cover such applications as commercial,industrial, and automotives areas.

We are looking forward to setting up business relationship with you and hope to provide you with the best service and solution. Let us make a better world for our industry!



## Contact us

Tel: +86-755-8981 8866 Fax: +86-755-8427 6832

Email & Skype: info@chipsmall.com Web: www.chipsmall.com

Address: A1208, Overseas Decoration Building, #122 Zhenhua RD., Futian, Shenzhen, China



# D Series Miniature Snap-in Power Rocker Switches

## Features/Benefits

- Momentary and maintained models
- PC and quick connect terminals
- Recessed bracket available — prevents accidental actuation
- RoHS compliant
- Gold plated options available

## Typical Applications

- Small appliances
- Computers and peripherals
- Medical instrumentation



UL 61058-1



## Specifications

CONTACT RATING:

D101, D102, D103, D105, D108, D201, D202, D203

GP (general purpose)

4 AMPS 125 VAC 50/60 Hz T85 10,000 cycles

2 AMPS 250 VAC 50/60 Hz T85 10,000 cycles

R (resistive)

4 AMPS 30 VDC T85 10,000 cycles

D501, D502, D503, D508, D601, D602, D608

GP (general purpose)

10 AMPS 125 VAC 50/60 Hz T85 10,000 cycles

5 AMPS 250 VAC 50/60 Hz T85 10,000 cycles

R (resistive)

10 AMPS 30 VDC T85 10,000 cycles

0.4VA @ 20V AC/DC (gold plating) available upon request

ELECTRICAL LIFE: 10,000 make-and-break cycles at full load.

INSULATION RESISTANCE:  $10^9 \Omega$  min.

DIELECTRIC STRENGTH: 1,000 Vrms min. @ sea level.

## Materials

ACTUATOR & HOUSING: 6/6 nylon (UL 94V-2), color black, finish: matte.

MOVABLE CONTACTS: D10X and D20X Models: Copper, silver plated. D50X and D60X Models: Coin silver, silver plated.

STATIONARY CONTACTS AND TERMINALS: Copper or brass, silver plated. Gold plating available.

CONTACT SPRING: Music wire or stainless steel.

OPERATING TEMPERATURE: -30°C to +65°C

**NOTE:** Specifications and materials listed above are for standard switches. For information on specific and custom switches, consult Customer Service Center.

## Build-A-Switch

To order, simply select desired option from each category and place in the appropriate box. Available options are shown and described on pages G-61 through G-64. For additional options not shown in catalog, consult Customer Service Center.

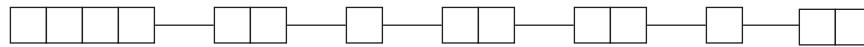

### Switch Function

- D101** SPDT, On-None-On
- D102** SPST, On-None-Off
- D103** SPDT, On-Off-On
- D105** SPDT, Mom.-Off-Mom.
- D108** SPDT, Mom.-None-On
- D201** DPDT, On-None-On
- D202** DPST, On-None-Off
- D203** DPDT, On-Off-On
- D501** SPDT, On-None-On
- D502** SPST, On-None-Off
- D503** SPDT, On-Off-On
- D508** SPDT, Mom.-None-On
- D601** DPDT, On-None-On
- D602** DPST, On-None-Off
- D608** DPDT, Mom.-None-On

### Actuator

- J1** Rocker
- J5** Lever

### Actuator Color

- 2** Black
- 1** White
- 3** Red

### Mounting Style/Color

- S2** Snap-in, black
- B2** Recessed snap-in actuator guard, black
- G2** Actuator guard, black
- S1** Snap-in, white

### Terminations

- 15** Quick connect
- A** Right angle, PC thru-hole
- 02** PC Thru-hole
- 05** Twisted quick connect
- 06** Extended PC thru-hole
- 17** Wirable quick connect

### Actuator Markings

- NONE** No marking
- D** ON-OFF
- H** 0 I
- N** Large dot
- P** 0 -
- R** Red rectangle on end
- U** Large dot on end

### Contact Material

- QA** Silver
- Gold plating options available contact Customer Service

Rocker



Dimensions are shown: Inches (mm)  
Specifications and dimensions subject to change

# D Series Miniature Snap-in Power Rocker Switches

## SWITCH FUNCTION

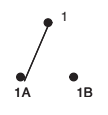
NO. POLES	MODEL NO.	AMP RATING*	SWITCH FUNCTION			CONNECTED TERMINALS			SCHEMATIC
			POS. 1	POS. 2	POS. 3	POS. 1	POS. 2	POS. 3	
SP	<b>D102</b>	4	ON	NONE	OFF			OPEN	SPST 
	<b>D502</b>	10					N/A		
	<b>D101</b>	4	ON	NONE	ON	1-1A	OPEN	1-1B	SPDT 
	<b>D501</b>	10		OFF					
	<b>D103</b>	4							
	<b>D503</b>	10							
<b>D105</b>	4		MOM.	OFF	MOM.				
<b>D108</b>	4		MOM.	NONE	ON				
<b>D508</b>	10						N/A		

### SPDT

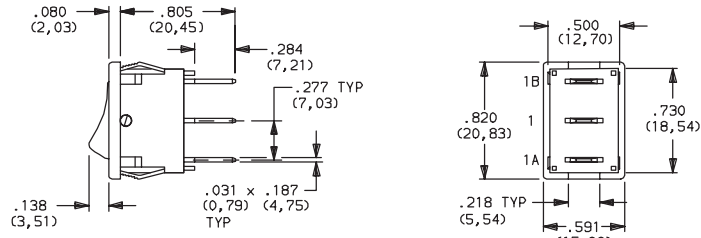

ACTUATOR SHOWN IN POSITION 1

TERMINAL NOS. FOR REF. ONLY

Part number shown: D101J12S215QA

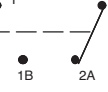
DP	<b>D202</b>	4	ON	NONE	OFF			OPEN	DPST 
	<b>D602</b>	10					N/A		
	<b>D201</b>	4	ON	NONE	ON	1-1A, 2-2A	OPEN	1-1B, 2-2B	DPDT 
	<b>D601</b>	10		OFF					
	<b>D203</b>	4							
<b>D608</b>	10		MOM.	NONE			N/A		

### DPDT

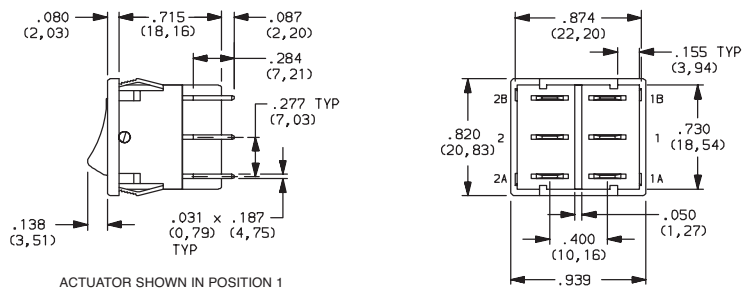

ACTUATOR SHOWN IN POSITION 1

TERMINAL NOS. FOR REF. ONLY

Part number shown: D201J12S215QA

MOM. = Momentary

\*AMP RATING: see G-60

See CONTACT MATERIALS, page G-64.

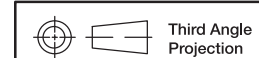

Third Angle Projection

Dimensions are shown: Inches (mm)  
Specifications and dimensions subject to change



# D Series Miniature Snap-in Power Rocker Switches



## J1 ROCKER

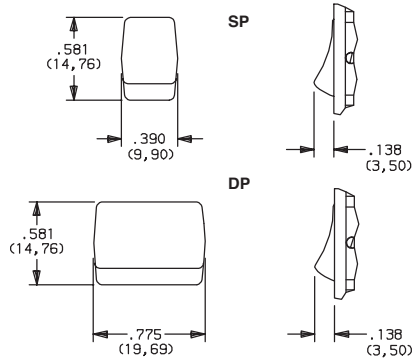

## J5 LEVER

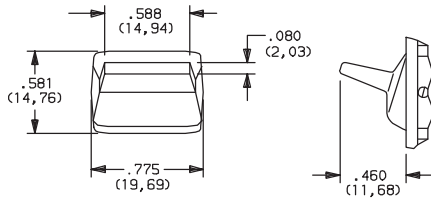

OPTION CODE	ACTUATOR COLOR
2	BLACK
1	WHITE
3	RED

**NOTE:** Actuator finish: matte. Other colors available, consult Customer Service Center.

'J5' actuator available only with DP models D201, D202, D601 and D602.



## S SNAP-IN

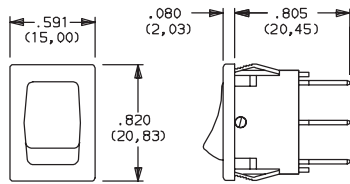

OPTION CODE	HOUSING COLOR
2	(STD.) BLACK
1	WHITE

**NOTE:** Frame finish on housing: matte. Other colors available, consult Customer Service Center.

## B2 RECESSED SNAP-IN ACTUATOR GUARD, BLACK

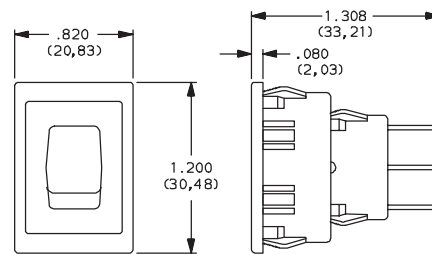

**NOTE:** Vertical mount, SP models only.

## G2 ACTUATOR GUARD, BLACK

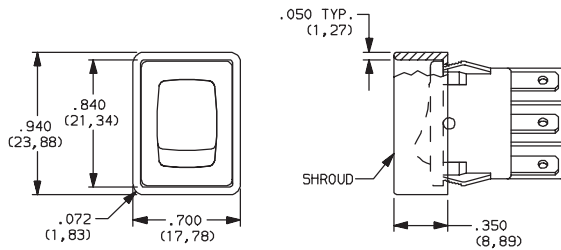

**NOTE:** Vertical mount, SP models only.

## PANEL MOUNTING

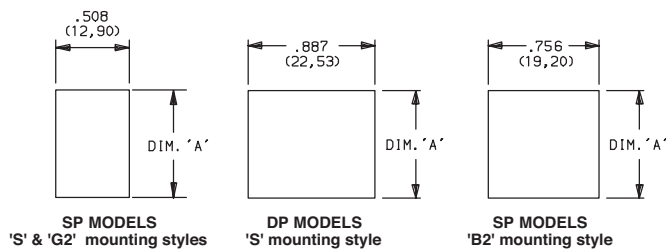

PANEL THICKNESS	DIM 'A' SP & DP MODELS 'S' MOUNTING STYLE	DIM 'A' WITH 'G2' OPTION SP MODELS ONLY	DIM 'A' SP MODELS 'B' MOUNTING STYLE
.030-.049 (0,76) (1,24)	.756 (19,20)	.764 (19,41)	1.068 (27,13)
.049-.079 (1,24) (2,01)	.764 (19,41)	.780 (19,81)	1.076 (27,33)
.079-.118 (2,01) (3,00)	.780 (19,81)	n/a	1.092 (27,74)

**NOTE:** Blank insert available for SP models only, see page G-64.

Rocker



Dimensions are shown: Inches (mm)  
Specifications and dimensions subject to change

# D Series Miniature Snap-in Power Rocker Switches

## TERMINATIONS

### A RIGHT ANGLE, PC THRU-HOLE

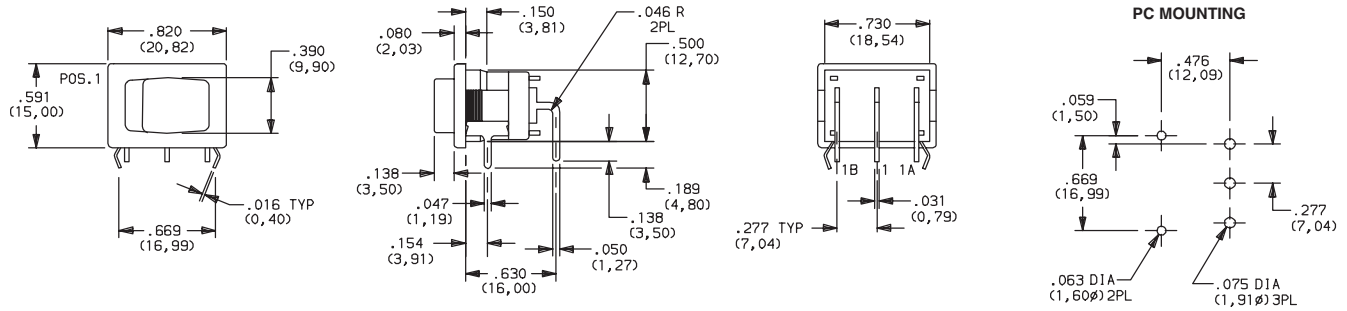

Available with D101, D102, D501, D502 SP models only.

## TERMINATIONS

### 02 PC THRU-HOLE

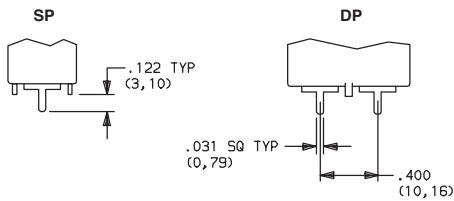

### 06 EXTENDED PC THRU-HOLE

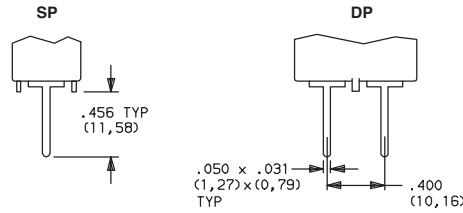

### PC MOUNTING (02 and 06)

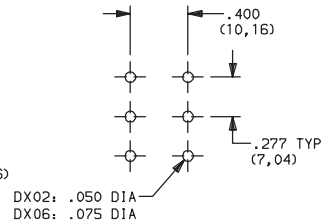

Available with DX01 and DX02 models only.

Available with DX01 and DX02 models only.

### 15 QUICK CONNECT

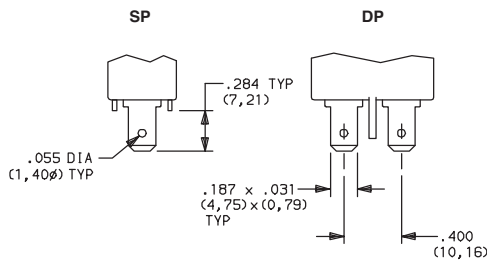

### 05 TWISTED QUICK CONNECT

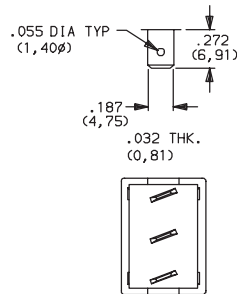

### 17 WIRABLE QUICK CONNECT

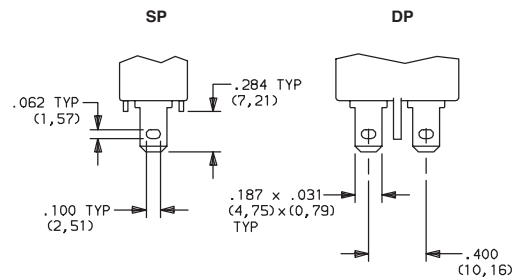

Available with DX01 and DX02 models only.

**NOTE: Terminals are twisted.**

Available with DX01 and DX02 models only.

## ACTUATORS

**NONE** NO MARKING

**D** ON-OFF

**H** O |

**N** LARGE DOT

**P** O -

**R** RED RECTANGLE  
ON END

**U** LARGE DOT ON END

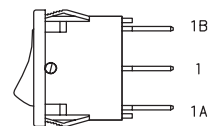

'D, H, P & U' marking options: marking color white, standard for all actuator colors except white. Black marking color, standard for white actuators. 'R & N' marking option: red marking color, standard. Consult Customer Service Center for other available marking colors.

**NOTE:** Orientation of actuator markings and terminals.

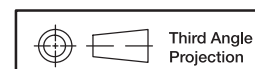

Third Angle  
Projection

Dimensions are shown: Inches (mm)  
Specifications and dimensions subject to change



# D Series Miniature Snap-in Power Rocker Switches

## CONTACT MATERIAL

OPTION CODE	CONTACT AND TERMINAL MATERIAL	RATINGS
<b>QA</b>	SILVER 1	D101, D102, D103, D105, D108, D201, D202, D203
		GP (general purpose) 4 AMPS 125 VAC 50/60 Hz T85 10,000 cycles
		2 AMPS 250 VAC 50/60 Hz T85 10,000 cycles
		R (resistive) 4 AMPS 30 VDC T85 10,000 cycles
		D501, D502, D503, D508, D601, D602, D608
		GP (general purpose) 10 AMPS 125 VAC 50/60 Hz T85 10,000 cycles
		5 AMPS 250 VAC 50/60 Hz T85 10,000 cycles
		R (resistive) 10 AMPS 30 VDC T85 10,000 cycles

<sup>1</sup>MOVABLE CONTACT: D10X and D20X MODELS: Copper, silver plated.  
D50X and D60X MODELS: Coin silver, silver plated.



0.4VA @ 20V AC/DC Gold plated options available contact Customer Service.

STATIONARY CONTACTS & TERMINALS: Copper or brass, silver plated.

## AVAILABLE HARDWARE

**Insert**  
SP Only

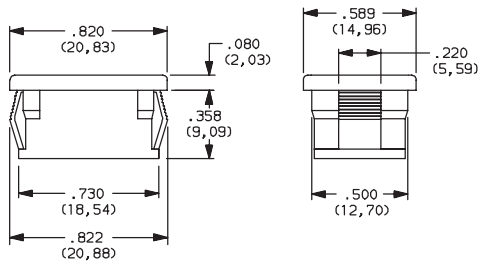

**PART NO.**

**057190200** BLACK

Material: Nylon 6/6  
Finish: Matte

**Recessed Actuator Guard,**  
SP Only



**599D02000** BLACK

Material: 6/6 Nylon  
Finish: Matte

**Actuator Guard**

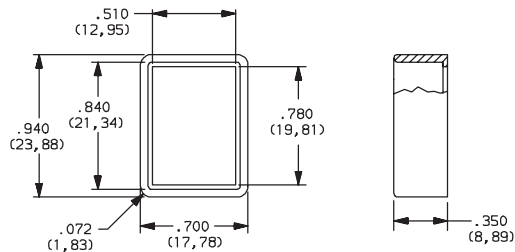

**PART NO.**

**104C22000**

Material: PBT thermoplastic  
Finish: Matte

**PART NO.**

**216C00000** IP65 SPLASH PROOF RUBBER BOOT

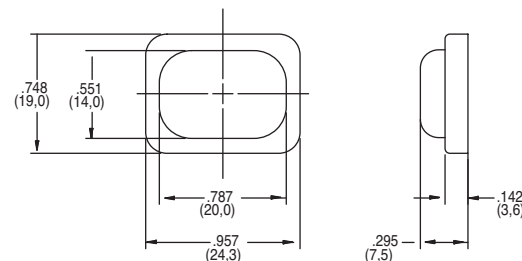

Rocker



G

**C&K**



Third Angle Projection

Dimensions are shown: Inches (mm)  
Specifications and dimensions subject to change