



Chipsmall Limited consists of a professional team with an average of over 10 year of expertise in the distribution of electronic components. Based in Hongkong, we have already established firm and mutual-benefit business relationships with customers from,Europe,America and south Asia,supplying obsolete and hard-to-find components to meet their specific needs.

With the principle of “Quality Parts,Customers Priority,Honest Operation,and Considerate Service”,our business mainly focus on the distribution of electronic components. Line cards we deal with include Microchip,ALPS,ROHM,Xilinx,Pulse,ON,Everlight and Freescale. Main products comprise IC,Modules,Potentiometer,IC Socket,Relay,Connector.Our parts cover such applications as commercial,industrial, and automotives areas.

We are looking forward to setting up business relationship with you and hope to provide you with the best service and solution. Let us make a better world for our industry!



Contact us

Tel: +86-755-8981 8866 Fax: +86-755-8427 6832

Email & Skype: info@chipsmall.com Web: www.chipsmall.com

Address: A1208, Overseas Decoration Building, #122 Zhenhua RD., Futian, Shenzhen, China



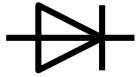

Technische Information / technical information



Schnelle beschaltungslose Diode
Fast Hard Drive Diode

D1600U

Infineon Technologies Bipolar
GmbH & Co. KG

Key Parameters

V_{RRM}	4500 V
I_{FAVM}	1560 A ($T_C=65\text{ }^\circ\text{C}$)
I_{FSM}	28000 A
V_{T0}	1,8 V
r_T	0,994 m Ω
R_{thJC}	7,5 K/W
Clamping Force	36 ... 65 kN
Max. Diameter	121 mm
Contact Diameter	86 mm
Height	26 mm



For type designation please refer to actual
short form catalog

<http://www.ifbip.com/catalog>

Merkmale

- Volle Sperrfähigkeit 50/60Hz über einen weiten Temperaturbereich
- Hohe DC Sperrstabilität
- Hohe Stoßstrombelastbarkeit
- Hoher Gehäusebruchstrom
- Sanftes Ausschaltverhalten bei hohen Stromsteilheiten

Features

- Full blocking capability 50/60Hz over a wide temperature range
- High DC blocking stability
- High surge current capability
- High case non-rupture current
- Soft turn-off behavior at high turn-off di/dt

Typische Anwendungen

- Mittelspannungsumrichter
- Freilaufdiode für IGCT - Applikationen
- Freilaufdiode für IGBT - Applikationen
- Pulsed Power - Applikationen

Typical Applications

- Medium voltage converters
- Freewheeling Diode for IGCT - applications
- Freewheeling Diode for IGBT - applications
- Pulsed power applications

content of customer DMX code	DMX code digit	DMX code digit quantity
serial number	1..7	7
SP material number	8..16	9
datecode (production day)	17..18	2
datecode (production year)	19..20	2
datecode (production month)	21..22	2
vT class (optional)	23..26	4
QR class (optional)	27..30	4

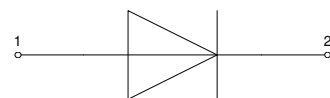

www.ifbip.com
support@infineon-bip.com

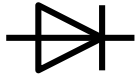

Technische Information / technical information



Infineon Technologies Bipolar
GmbH & Co. KG

**Schnelle beschaltungslose Diode
Fast Hard Drive Diode**

D1600U

Elektrische Eigenschaften / Electrical properties Höchstzulässige Werte / Maximum rated values

Periodische Rückwärts-Spitzenperrspannung repetitive peak reverse voltage	$T_{vj} = 0^{\circ}\text{C} \dots T_{vj\text{max}}$	V_{RRM}	4500	V
Durchlaßstrom-Grenzeffektivwert maximum RMS on-state current	$T_c = 65^{\circ}\text{C}$	I_{FRMSM}	2450	A
Dauergrenzstrom average on-state current	$T_c = 65^{\circ}\text{C}, f=50\text{Hz}$ $T_c = 55^{\circ}\text{C}, f=50\text{Hz}$	I_{FAVM}	1560 1680	A A
Stoßstrom-Grenzwert surge current	$T_{vj} = 25^{\circ}\text{C}, t_p = 10\text{ms}$ $T_{vj} = T_{vj\text{max}}, t_p = 10\text{ms}$	I_{FSM}	28000	A A
Grenzlastintegral I^2t -value	$T_{vj} = 25^{\circ}\text{C}, t_p = 10\text{ms}$ $T_{vj} = T_{vj\text{max}}, t_p = 10\text{ms}$	I^2t	3920	$10^3\text{A}^2\text{s}$ $10^3\text{A}^2\text{s}$
Max. Ausschaltverluste max. turn-off losses	$T_{vj} = T_{vj\text{max}}$ $I_{FM}=4500\text{A}, -di/dt=5000\text{A}/\mu\text{s},$ $V_{DC}=3000\text{V}, L_s<240\text{nH}, t_{on}=40\mu\text{s}$	P_{RQ}	9	MW

Charakteristische Werte / Characteristic values

Gleichsperrspannung continuous direct reverse voltage	failure rate $\lambda < 100$	$V_{R(D)}$	estimate value	2800	V
Durchlaßspannung on-state voltage	$T_{vj} = T_{vj\text{max}}, i_F = 2500\text{A}$	v_F	typ. max.	4,0 4,3	V V
Schleusenspannung threshold voltage	$T_{vj} = T_{vj\text{max}}$	$V_{(TO)}$	typ. max.	1,72 1,8	V V
Ersatzwiderstand slope resistance	$T_{vj} = T_{vj\text{max}}$	r_T	typ. max.	0,926 0,994	mΩ mΩ
Durchlaßkennlinie on-state characteristic $1000\text{A} \leq i_F \leq 3000\text{A}$ $v_F = A + B \cdot i_F + C \cdot \ln(i_F + 1) + D \cdot \sqrt{i_F}$	$T_{vj} = T_{vj\text{max}}$	typ.	A B C D	0,70113084 0,00011385 -0,0503671 0,06879726	
		max.	A B C D	0,69909626 0,00012249 -0,0512452 0,07368193	
Spitzenwert der Durchlassverzögerungsspannung peak value of forward recovery voltage	$T_{vj} = T_{vj\text{max}}, di_F/dt = 5000\text{A}/\mu\text{s}$ $I_{FM} = 4000\text{A}$	V_{FRM}	typ.	250	V
Sperrstrom reverse current	$T_{vj} = T_{vj\text{max}}, V_R = V_{RRM}$	i_R	max.	150	mA
Sperrverzögerungsladung recovered charge	$T_{vj} = T_{vj\text{max}}$	Q_r	max.	6	mAs
Rückstromspitze peak reverse recovery current	$I_{FM}=4500\text{A}, -di/dt=5000\text{A}/\mu\text{s},$ $V_{DC}=3000\text{V}, L_s<240\text{nH}, t_{on}=40\mu\text{s}$	I_{RM}	max.	3600	A
Ausschaltverlust Energie turn-off energy		W_{RQ}	max.	13,5	Ws
Abklingsantheit reverse recovery softness factor	$T_{vj} = T_{vj\text{max}}$ $I_{FM} = 2500\text{A}, V_R = 2800\text{V},$ $-di_r/dt(i=0) = 1000\text{A}/\mu\text{s}, \Delta t_{rf} = 200\text{ns}$	F_{RRS}	typ.	1,6	

prepared by:	TM	date of publication:	2017-03-27
approved by:	JP	revision:	1.1

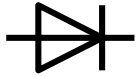

Thermische Eigenschaften / Thermal properties

Innerer Wärmewiderstand thermal resistance, junction to case	<u>Kühlfläche / cooling surface</u> beidseitig / two-sided, $\theta = 180^\circ\text{sin}$ beidseitig / two-sided, DC Anode / anode, DC Kathode / cathode, DC	R_{thJC}	max. 8,55 max. 7,5 max. 13,3 max. 17,2	K/kW K/kW K/kW K/kW
Übergangs-Wärmewiderstand thermal resistance, case to heatsink	<u>Kühlfläche / cooling surface</u> beidseitig / two-sided einseitig / single-sided	R_{thCH}	max. 2,5 max. 5,0	K/kW K/kW
Höchstzulässige Sperrschichttemperatur maximum junction temperature		$T_{\text{vj max}}$	140	°C
Betriebstemperatur operating temperature		$T_{\text{c op}}$	0...+140	°C
Lagertemperatur storage temperature		T_{stg}	-40...+150	°C

Mechanische Eigenschaften / Mechanical properties

Gehäuse, siehe Anlage case, see annex			Seite 4 page 4	
Si-Element mit Druckkontakt Si-pellet with pressure contact				
Anpresskraft clamping force		F	36...65	kN
Gewicht weight		G	typ. 1500	g
Kriechstrecke creepage distance			33	mm
Luftstrecke air distance			17	mm
Feuchtklasse humidity classification	DIN 40040		C	
Schwingfestigkeit vibration resistance	f = 50 Hz		50	m/s ²

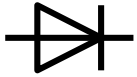

Technische Information /
technical information



Schnelle beschaltungslose Diode
Fast Hard Drive Diode

D1600U

Infineon Technologies Bipolar
GmbH & Co. KG

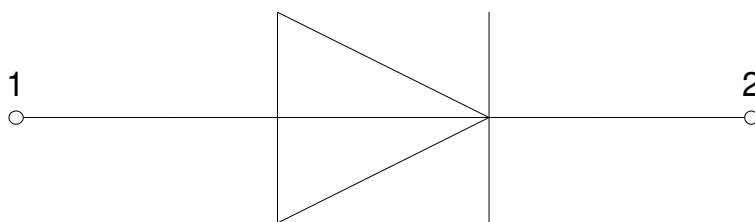
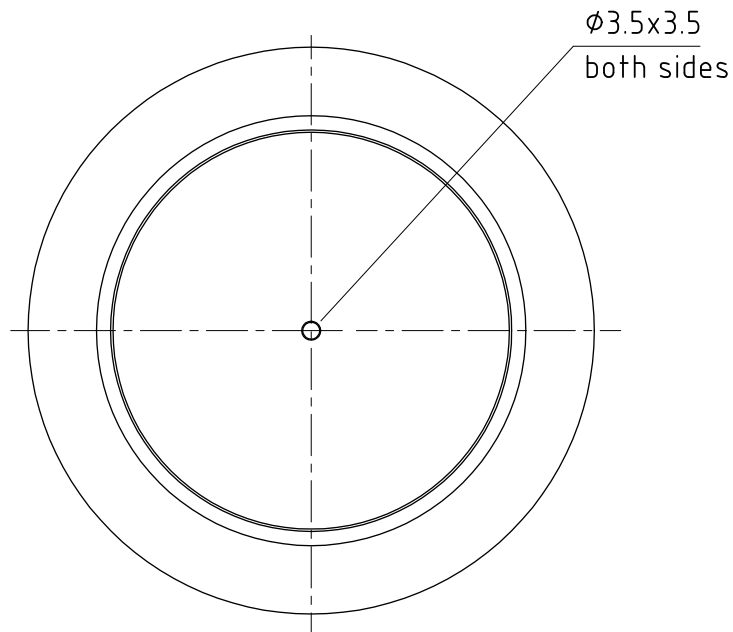
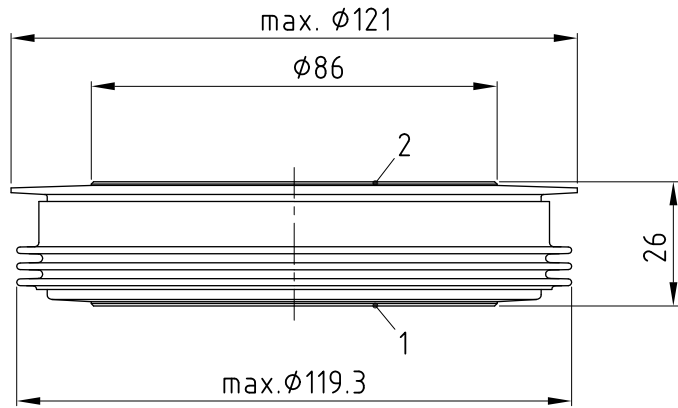

1: Anode/Anode

2: Kathode/Cathode

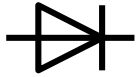

Analytische Elemente des transienten Wärmewiderstandes Z_{thJC}
Analytical elements of transient thermal impedance Z_{thJC}

	Pos. n	1	2	3	4	5	6	7
beidseitig two-sided	R_{thn} [K/kW]	2,95	2	1,54	0,98	0,03		
	τ_n [s]	0,78	0,131	0,0217	0,00514	0,00104		
anodenseitig anode-sided	R_{thn} [K/kW]	8,04	0,81	2,39	1,6	0,46		
	τ_n [s]	5,11	0,359	0,0962	0,012	0,00332		
kathodenseitig cathode-sided	R_{thn} [K/kW]	12,1	0,4	2,44	1,55	0,71		
	τ_n [s]	4,97	0,489	0,121	0,0153	0,00427		

Analytische Funktion / Analytical function:
$$Z_{thJC} = \sum_{n=1}^{n_{max}} R_{thn} \left(1 - e^{-\frac{t}{\tau_n}} \right)$$

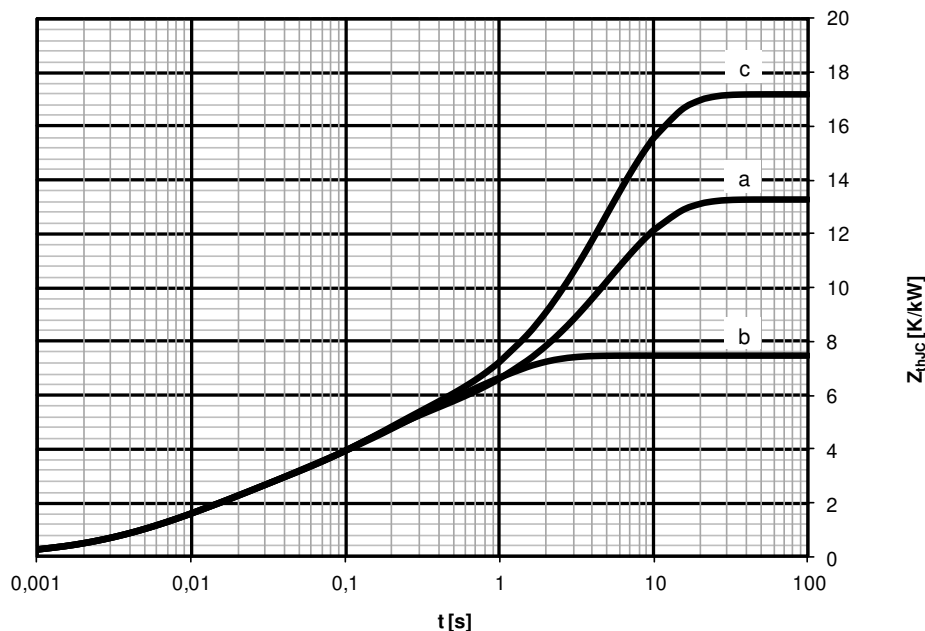

Transienter innerer Wärmewiderstand für DC/ Transient thermal impedance $Z_{thJC} = f(t)$ for DC

a : Anodenseitige Kühlung / Anode-sided cooling

b : Beidseitige Kühlung / Two-sided cooling

c : Kathodenseitige Kühlung / Cathode-sided cooling

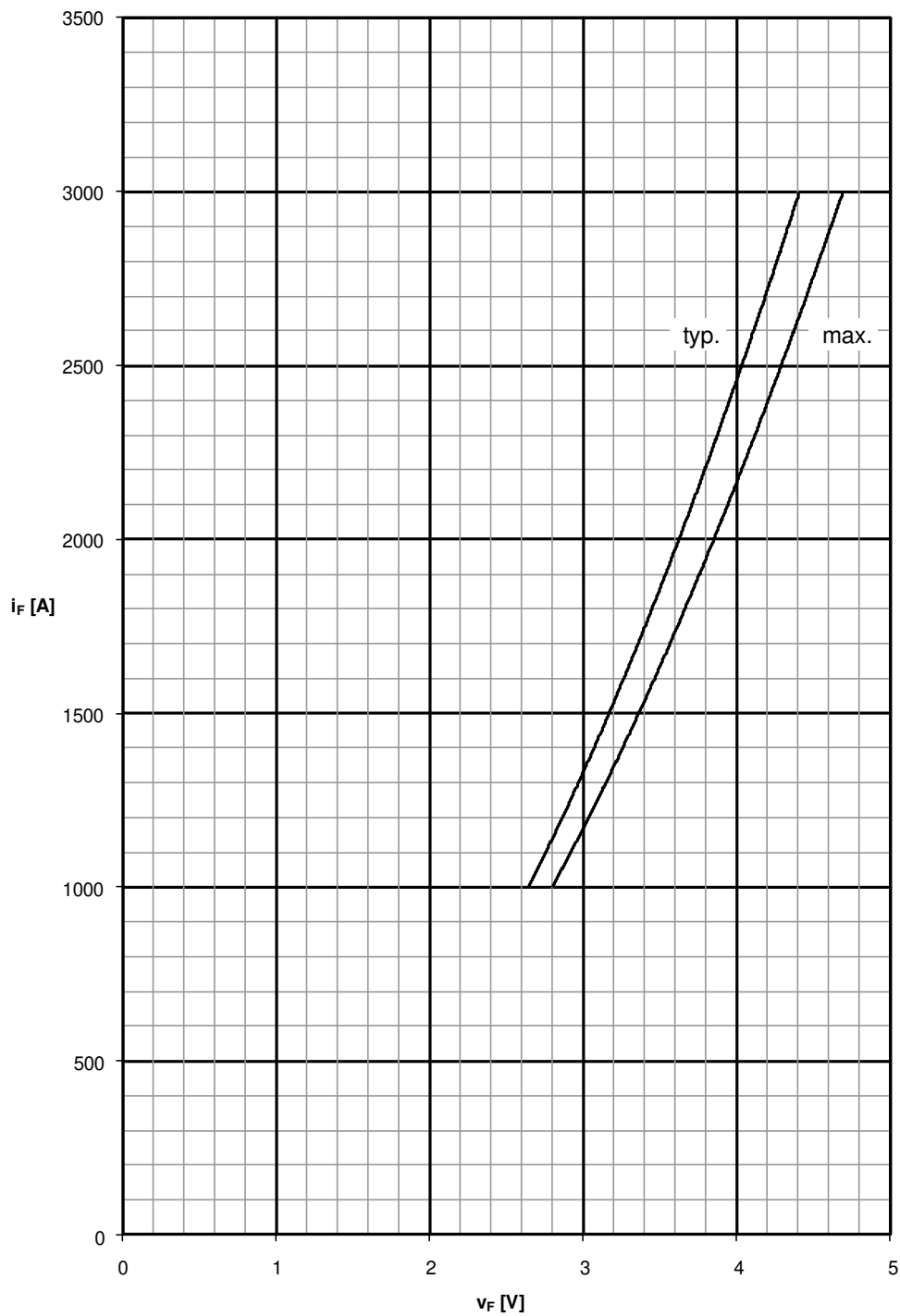
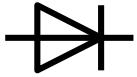

Grenzdurchlaßkennlinie / Limiting on-state characteristic $i_F = f(v_F)$

$$T_{vj} = T_{vj \text{ max}}$$

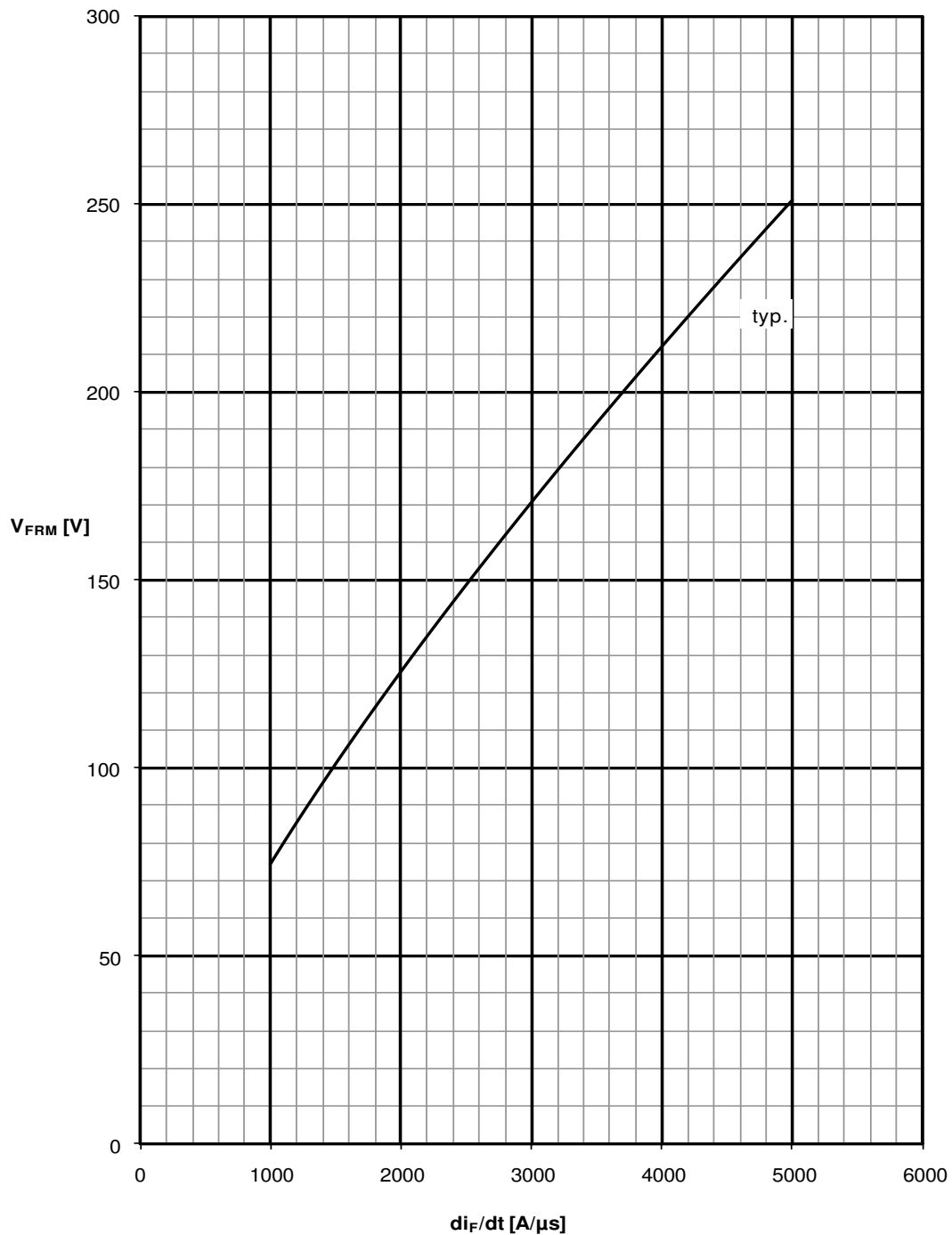
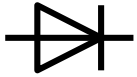

Spitzenwert-Durchlassverzögerungsspannung / peak value forward recovery voltage $V_{FRM} = f(di_F/dt)$

$$T_{vj} = T_{vjmax}, I_{FM} = 4000A$$



Nutzungsbedingungen

Die in diesem Produktdatenblatt enthaltenen Daten sind ausschließlich für technisch geschultes Fachpersonal bestimmt. Die Beurteilung der Geeignetheit dieses Produktes für die von Ihnen anvisierte Anwendung sowie die Beurteilung der Vollständigkeit der bereitgestellten Produktdaten für diese Anwendung obliegt Ihnen bzw. Ihren technischen Abteilungen.

In diesem Produktdatenblatt werden diejenigen Merkmale beschrieben, für die wir eine liefervertragliche Gewährleistung übernehmen. Eine solche Gewährleistung richtet sich ausschließlich nach Maßgabe der im jeweiligen Liefervertrag enthaltenen Bestimmungen. Garantien jeglicher Art werden für das Produkt und dessen Eigenschaften keinesfalls übernommen.

Sollten Sie von uns Produktinformationen benötigen, die über den Inhalt dieses Produktdatenblatts hinausgehen und insbesondere eine spezifische Verwendung und den Einsatz dieses Produktes betreffen, setzen Sie sich bitte mit dem für Sie zuständigen Vertriebsbüro in Verbindung (siehe www.eupec.com, Vertrieb&Kontakt). Für Interessenten halten wir Application Notes bereit.

Aufgrund der technischen Anforderungen könnte unser Produkt gesundheitsgefährdende Substanzen enthalten. Bei Rückfragen zu den in diesem Produkt jeweils enthaltenen Substanzen setzen Sie sich bitte ebenfalls mit dem für Sie zuständigen Vertriebsbüro in Verbindung.

Sollten Sie beabsichtigen, das Produkt in Anwendungen der Luftfahrt, in gesundheits- oder lebensgefährdenden oder lebenserhaltenden Anwendungsbereichen einzusetzen, bitten wir um Mitteilung. Wir weisen darauf hin, dass wir für diese Fälle

- die gemeinsame Durchführung eines Risiko- und Qualitätsassessments;
- den Abschluss von speziellen Qualitätssicherungsvereinbarungen;
- die gemeinsame Einführung von Maßnahmen zu einer laufenden Produktbeobachtung dringend empfehlen und gegebenenfalls die Belieferung von der Umsetzung solcher Maßnahmen abhängig machen.

Soweit erforderlich, bitten wir Sie, entsprechende Hinweise an Ihre Kunden zu geben.

Inhaltliche Änderungen dieses Produktdatenblatts bleiben vorbehalten.

Terms & Conditions of usage

The data contained in this product data sheet is exclusively intended for technically trained staff. You and your technical departments will have to evaluate the suitability of the product for the intended application and the completeness of the product data with respect to such application.

This product data sheet is describing the characteristics of this product for which a warranty is granted. Any such warranty is granted exclusively pursuant to the terms and conditions of the supply agreement. There will be no guarantee of any kind for the product and its characteristics.

Should you require product information in excess of the data given in this product data sheet or which concerns the specific application of our product, please contact the sales office, which is responsible for you (see www.eupec.com, sales&contact). For those that are specifically interested we may provide application notes.

Due to technical requirements our product may contain dangerous substances. For information on the types in question please contact the sales office, which is responsible for you.

Should you intend to use the Product in aviation applications, in health or life endangering or life support applications, please notify. Please note, that for any such applications we urgently recommend

- to perform joint Risk and Quality Assessments;
- the conclusion of Quality Agreements;
- to establish joint measures of an ongoing product survey, and that we may make delivery depended on the realization of any such measures.

If and to the extent necessary, please forward equivalent notices to your customers.

Changes of this product data sheet are reserved.