



Chipsmall Limited consists of a professional team with an average of over 10 year of expertise in the distribution of electronic components. Based in Hongkong, we have already established firm and mutual-benefit business relationships with customers from,Europe,America and south Asia,supplying obsolete and hard-to-find components to meet their specific needs.

With the principle of “Quality Parts,Customers Priority,Honest Operation,and Considerate Service”,our business mainly focus on the distribution of electronic components. Line cards we deal with include Microchip,ALPS,ROHM,Xilinx,Pulse,ON,Everlight and Freescale. Main products comprise IC,Modules,Potentiometer,IC Socket,Relay,Connector.Our parts cover such applications as commercial,industrial, and automotives areas.

We are looking forward to setting up business relationship with you and hope to provide you with the best service and solution. Let us make a better world for our industry!



Contact us

Tel: +86-755-8981 8866 Fax: +86-755-8427 6832

Email & Skype: info@chipsmall.com Web: www.chipsmall.com

Address: A1208, Overseas Decoration Building, #122 Zhenhua RD., Futian, Shenzhen, China

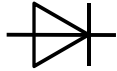

Netz-Gleichrichterdiode
Rectifier Diode
D1800N
Elektrische Eigenschaften / Electrical properties

Höchstzulässige Werte / maximum rated values

Periodische Spitzensperrspannung repetitive peak reverse voltages	$T_{vj} = -40^{\circ}\text{C} \dots T_{vj \max}$	V_{RRM}	3600 4000 4200	4400 4600 4800	V V V
Durchlaßstrom-Grenzeffektivwert maximum RMS on-state current		I_{FRMSM}		3850	A
Dauergrenzstrom average on-state current	$T_C = 100^{\circ}\text{C}$	I_{FAVM}		1800	A
Dauergrenzstrom average on-state current	$T_C = 55^{\circ}\text{C}, \theta = 180^{\circ}\text{sin}, t_p = 10 \text{ ms}$	I_{FAVM}		2550	A
Durchlaßstrom-Effektivwert RMS on-state current		I_{FRMS}		4000	A
Stoßstrom-Grenzwert surge current	$T_{vj} = 25^{\circ}\text{C}, t_p = 10 \text{ ms}$ $T_{vj} = T_{vj \max}, t_p = 10 \text{ ms}$	I_{FSM}		35000 27500	A A
Grenzlastintegral I^2t -value	$T_{vj} = 25^{\circ}\text{C}, t_p = 10 \text{ ms}$ $T_{vj} = T_{vj \max}, t_p = 10 \text{ ms}$	I^2t		6125 3781	$10^3\text{A}^2\text{s}$ $10^3\text{A}^2\text{s}$

Charakteristische Werte / Characteristic values

Durchlaßspannung on-state voltage	$T_{vj} = T_{vj \max}, i_F = 7,4 \text{ kA}$ $T_{vj} = T_{vj \max}, i_F = 1,5 \text{ kA}$	V_F	max. max.	2,82 1,32	V V
Schleusenspannung threshold voltage	$T_{vj} = T_{vj \max}$	$V_{(TO)}$		0,85	V
Ersatzwiderstand slope resistance	$T_{vj} = T_{vj \max}$	r_T		0,253	m Ω
Durchlaßkennlinie on-state characteristic $500 \text{ A} \leq i_F \leq 9000 \text{ A}$ $v_F = A + B \cdot i_F + C \cdot \ln(i_F + 1) + D \cdot \sqrt{i_F}$	$T_{vj} = T_{vj \max}$	A= B= C= D=		-7,537E-01 3,748E-04 3,443E-01 -2,660E-02	
Sperrstrom reverse current	$T_{vj} = T_{vj \max}, V_R = V_{RRM}$	i_R	max.	100	mA

Thermische Eigenschaften / Thermal properties

Innerer Wärmewiderstand thermal resistance, junction to case	<u>Kühlfläche / cooling surface</u> beidseitig / two-sided, $\theta = 180^{\circ}\text{sin}$ beidseitig / two-sided, DC Anode / anode, $\theta = 180^{\circ}\text{sin}$ Anode / anode, DC Kathode / cathode, $\theta = 180^{\circ}\text{sin}$ Kathode / cathode, DC	R_{thJC}	max. max. max. max. max.	0,0169 0,0160 0,0329 0,0320 0,0329	$^{\circ}\text{C/W}$ $^{\circ}\text{C/W}$ $^{\circ}\text{C/W}$ $^{\circ}\text{C/W}$ $^{\circ}\text{C/W}$
Übergangs-Wärmewiderstand thermal resistance, case to heatsink	<u>Kühlfläche / cooling surface</u> beidseitig / two-sided einseitig / single-sided	R_{thCH}	max. max.	0,0025 0,0050	$^{\circ}\text{C/W}$ $^{\circ}\text{C/W}$
Höchstzulässige Sperrschichttemperatur maximum junction temperature		$T_{vj \max}$		160	$^{\circ}\text{C}$
Betriebstemperatur operating temperature		$T_{c \text{ op}}$		-40...+160	$^{\circ}\text{C}$
Lagertemperatur storage temperature		T_{stg}		-40...+160	$^{\circ}\text{C}$

prepared by:	H.Sandmann	date of publication:	2008-09-15
approved by:	M.Leifeld	revision:	3.0

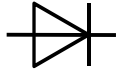

Netz-Gleichrichterdiode
Rectifier Diode

D1800N

Mechanische Eigenschaften / Mechanical properties

Gehäuse, siehe Anlage case, see annex			Seite 3 page 3	
Si-Element mit Druckkontakt Si-pellet with pressure contact				
Anpreßkraft clamping force		F	24...60	kN
Gewicht weight		G	typ. 600	g
Kriechstrecke creepage distance			25	mm
Schwingfestigkeit vibration resistance	f = 50 Hz		50	m/s ²

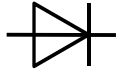
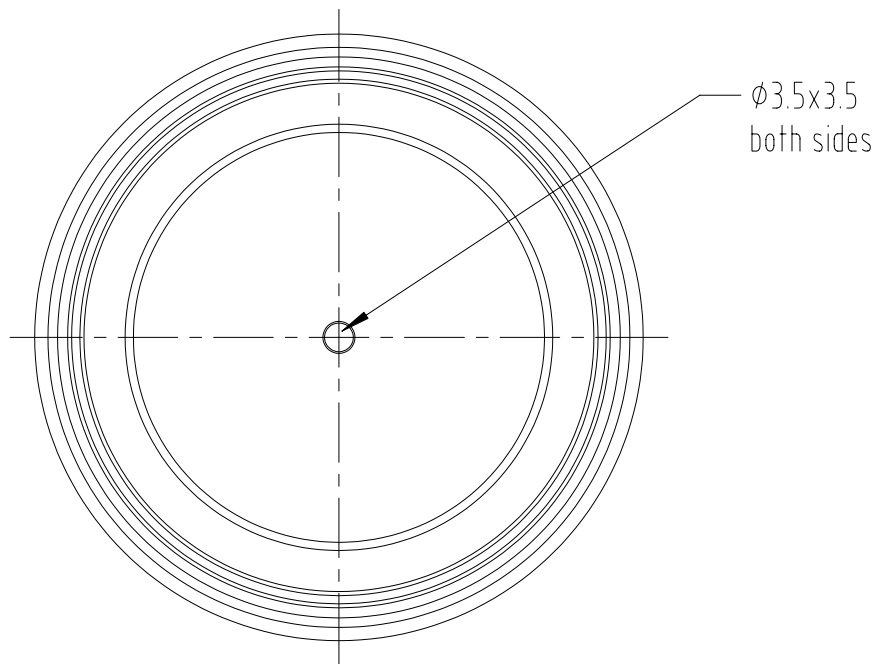
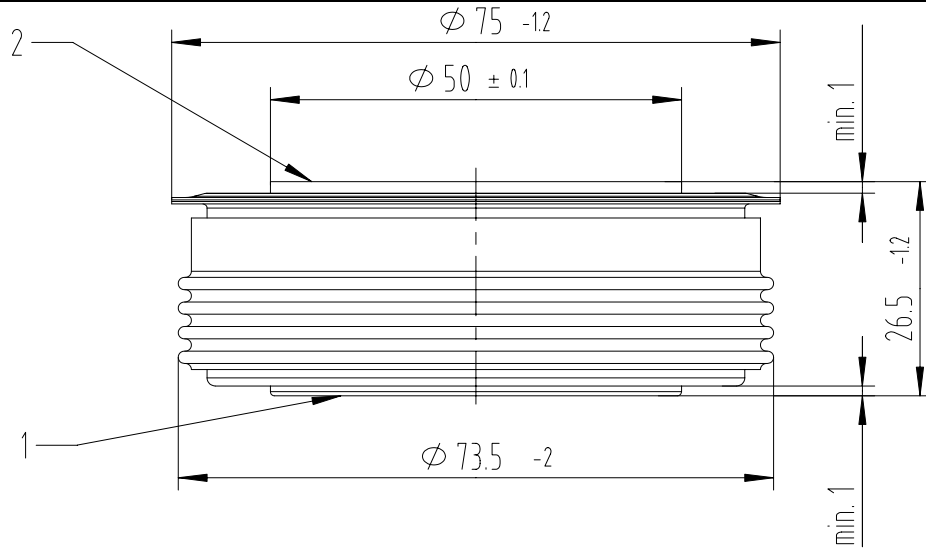
N**Datenblatt / Data sheet**
Netz-Gleichrichterdiode
Rectifier Diode
D1800N
 strike distance: 20mm
 Creepage distance: 25mm

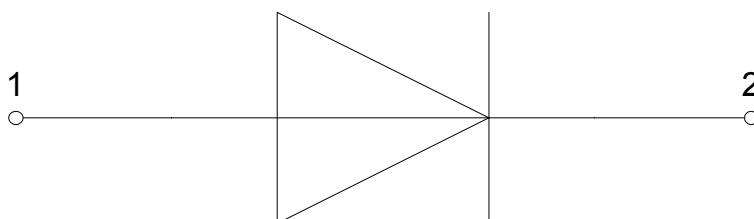
 overall height based
 on contact pressure

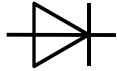
1: Anode/
Anode
2: Kathode/
Cathode

 Netz-Gleichrichterdiode
 Rectifier Diode

D1800N

Analytische Elemente des transienten Wärmewiderstandes Z_{thJC} für DC
Analytical elements of transient thermal impedance Z_{thJC} for DC

Kühlung / Cooling	Pos. n	1	2	3	4	5	6	7
beidseitig two-sided	R_{thn} [$^{\circ}C/W$]	0,000006	0,000407	0,001107	0,00206	0,00503	0,00739	-
	τ_n [s]	0,000184	0,001360	0,010800	0,04640	0,21900	1,15000	-
anodenseitig anode-sided	R_{thn} [$^{\circ}C/W$]	0,000201	0,000849	0,00235	0,00567	0,00443	0,0185	-
	τ_n [s]	0,000796	0,005330	0,03660	0,21400	2,79000	6,1100	-
kathodenseitig cathode-sided	R_{thn} [$^{\circ}C/W$]	0,000201	0,000849	0,00235	0,00567	0,00443	0,0185	-
	τ_n [s]	0,000796	0,005330	0,03660	0,21400	2,79000	6,1100	-

Analytische Funktion / Analytical function:

$$Z_{thJC} = \sum_{n=1}^{n_{max}} R_{thn} \left(1 - e^{-\frac{t}{\tau_n}} \right)$$

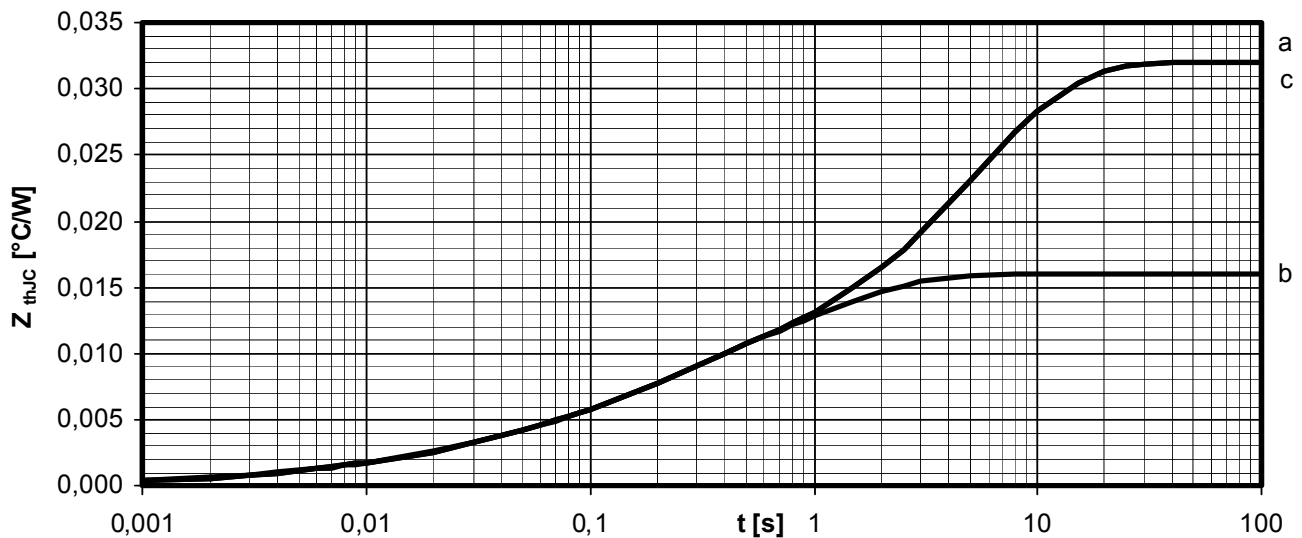
Transienter innerer Wärmewiderstand für DC / Transient thermal impedance for DC
 $Z_{thJC} = f(t)$

- a - Anodenseitige Kühlung / Anode-sided cooling
- b - Beidseitige Kühlung / Two-sided cooling
- c - Kathodenseitige Kühlung / Cathode-sided cooling

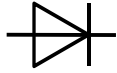
 Netz-Gleichrichterdiode
 Rectifier Diode

D1800N

 Erhöhung des $Z_{th DC}$ bei sinus- und rechteckförmigen Strömen für unterschiedliche Stromflusswinkel Θ
 Rise of $Z_{th DC}$ for sinewave and rectangular current for different current conduction angles Θ
 $\Delta Z_{th \Theta rec} / \Delta Z_{th \Theta sin}$

Kühlung / Cooling		$\Theta = 180^\circ$	$\Theta = 120^\circ$	$\Theta = 90^\circ$	$\Theta = 60^\circ$	$\Theta = 30^\circ$
beidseitig two-sided	$\Delta Z_{th \Theta rec}$ [°C/W]	0,00126	0,00202	0,00260	0,00348	0,00496
	$\Delta Z_{th \Theta sin}$ [°C/W]	0,00087	0,00122	0,00168	0,00249	0,00411
anodenseitig anode-sided	$\Delta Z_{th \Theta rec}$ [°C/W]	0,00130	0,00204	0,00260	0,00339	0,00479
	$\Delta Z_{th \Theta sin}$ [°C/W]	0,00096	0,00130	0,00175	0,00244	0,00391
kathodenseitig cathode-sided	$\Delta Z_{th \Theta rec}$ [°C/W]	0,00130	0,00204	0,00260	0,00339	0,00479
	$\Delta Z_{th \Theta sin}$ [°C/W]	0,00096	0,00130	0,00175	0,00244	0,00391

$$Z_{th \Theta rec} = Z_{th DC} + \Delta Z_{th \Theta rec}$$

$$Z_{th \Theta sin} = Z_{th DC} + \Delta Z_{th \Theta sin}$$

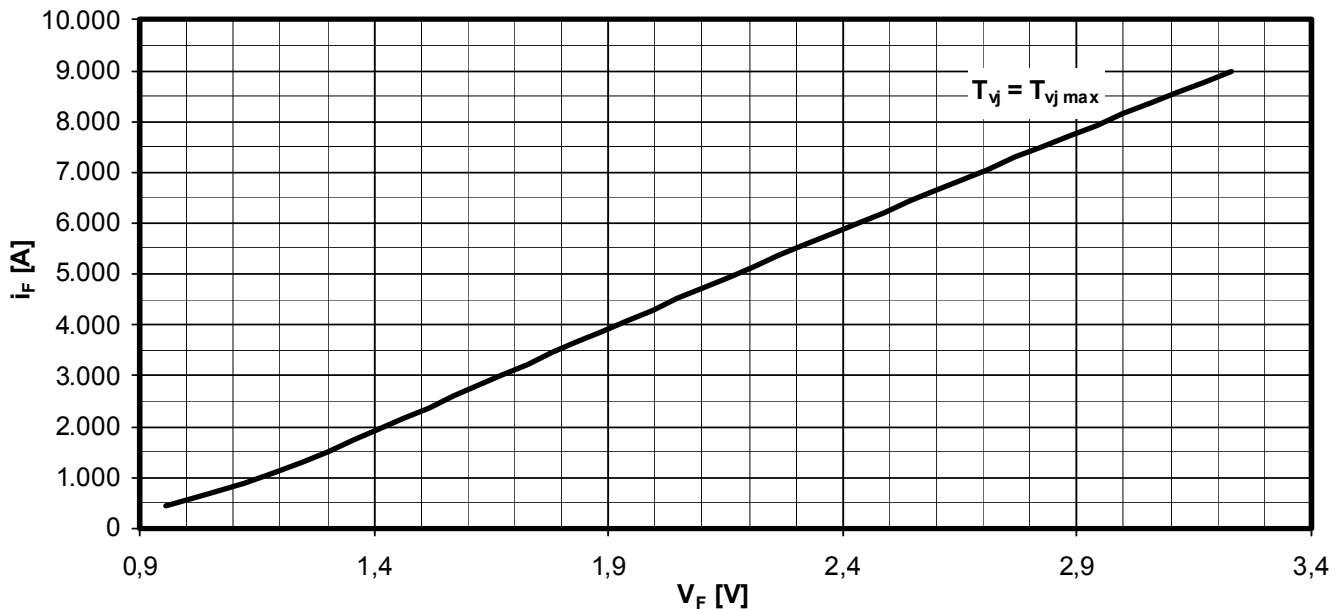

 Grenzdurchlasskennlinie / Limiting on-state characteristic $i_F = f(V_F)$

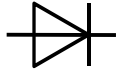
$$T_{vj} = T_{vj max}$$

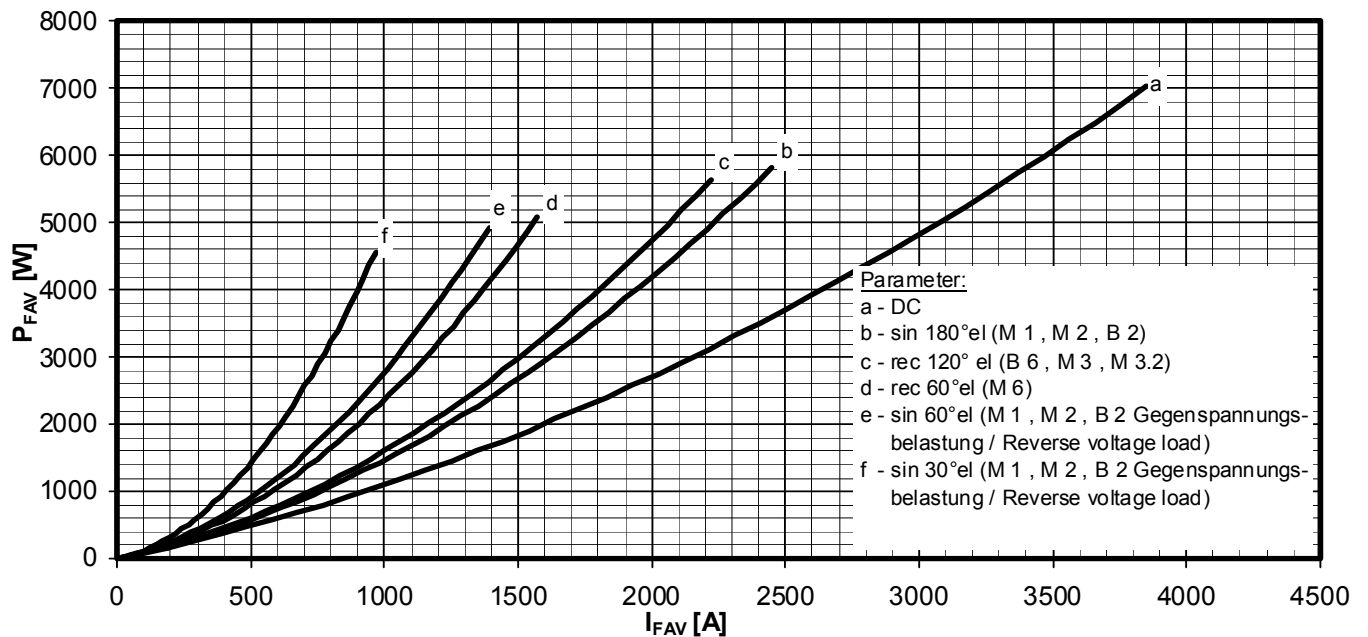

Netz-Gleichrichterdiode
Rectifier Diode

D1800N



Durchlassverlustleistung / On-state power loss $P_{FAV} = f(I_{FAV})$

Beidseitige Kühlung / Two-sided cooling

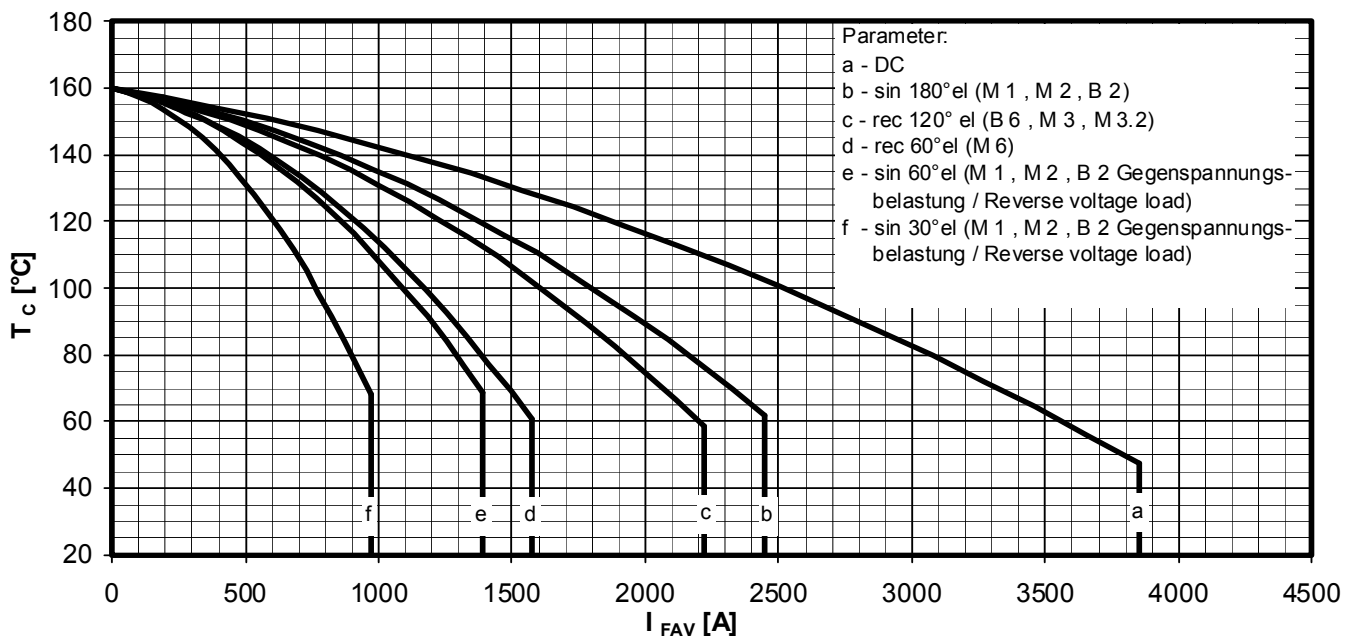

Höchstzulässige Gehäusetemperatur / Maximum allowable case temperature $T_c = f(I_{FAV})$

Beidseitige Kühlung / Two-sided cooling

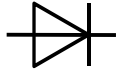

Netz-Gleichrichterdiode
Rectifier Diode

D1800N

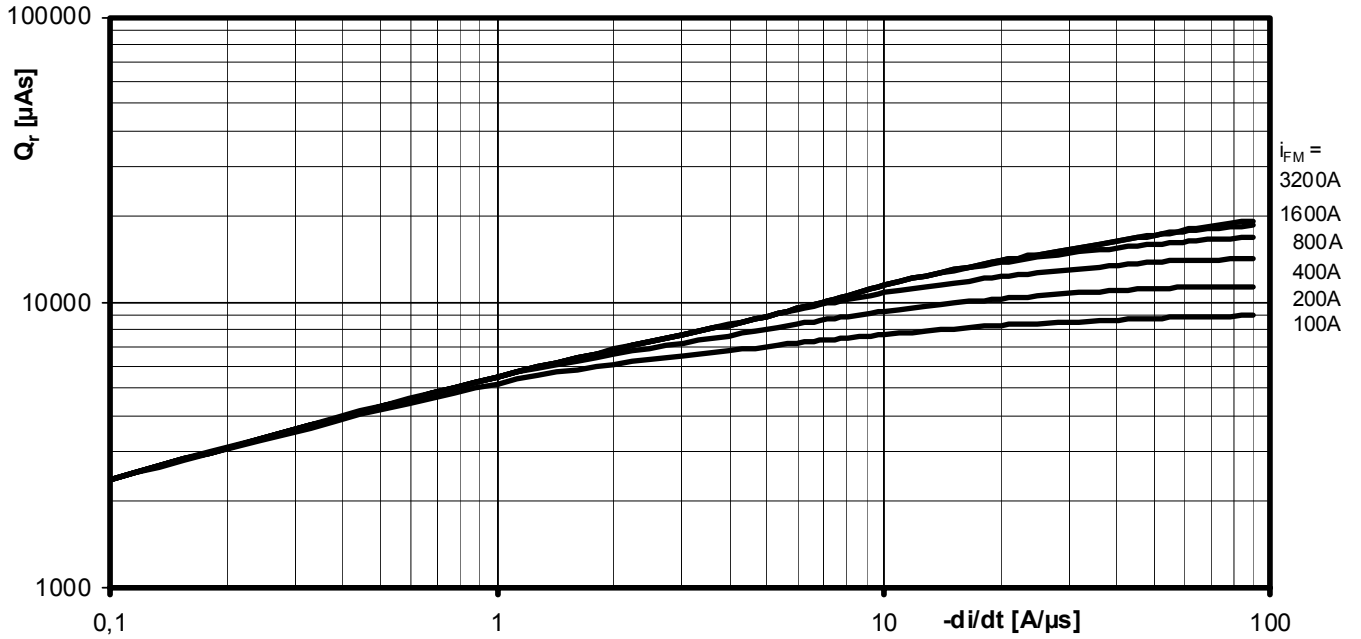

Sperrverzögerungsladung / Recovered charge

$$Q_r = f(-di/dt)$$

$$T_{vj} = T_{vjmax}, V_R \leq 0,5 V_{RRM}, V_{RM} = 0,8 V_{RRM}$$

$$\text{RC-Glied / RC-Network: } R = 2,7\Omega, C = 1,5\mu\text{F}$$

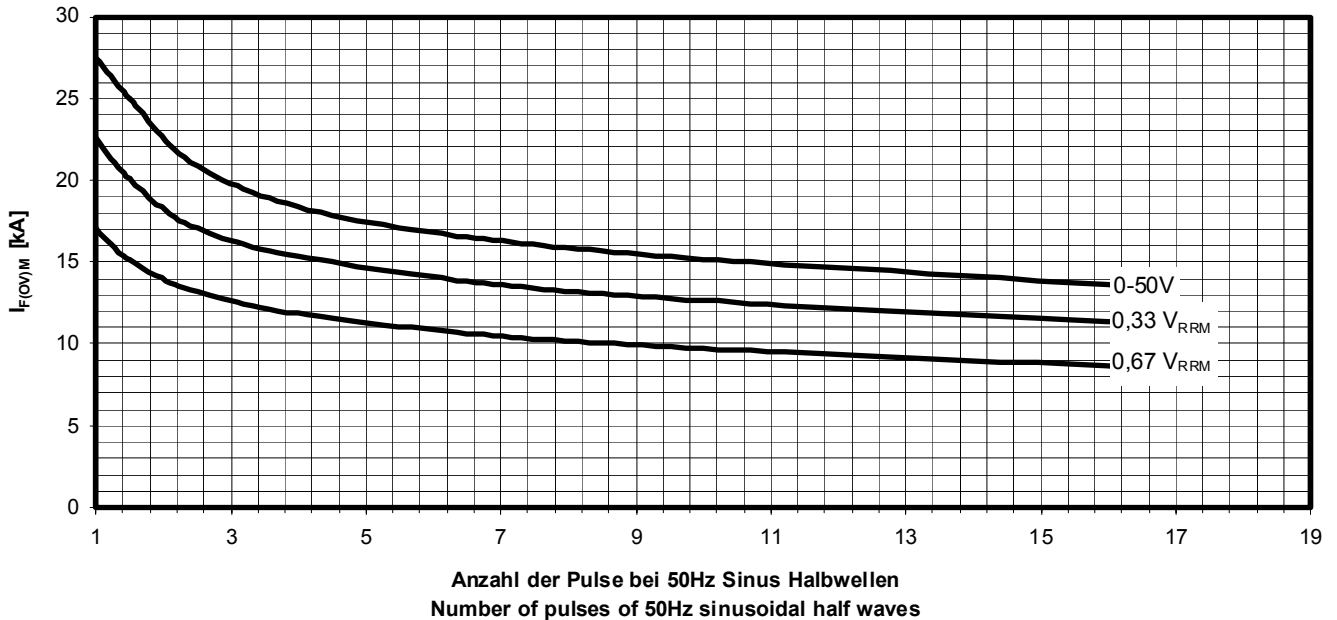

Typische Abhängigkeit des Grenzstromes $I_{F(OV)M}$ von der Anzahl für eine Folge von Sinus Halbwellen bei 50Hz. Parameter: Rückwärtsspannung V_{RM}
 Typical dependency of maximum overload on-state current $I_{F(OV)M}$ as a number of a sequence of sinusoidal half waves at 50Hz. Parameter: peak reverse voltage V_{RM}
 $I_{F(OV)M} = f(\text{pulses}, V_{RM}) ; T_{vj} = T_{vjmax}$

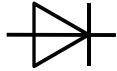

Nutzungsbedingungen

Die in diesem Produktdatenblatt enthaltenen Daten sind ausschließlich für technisch geschultes Fachpersonal bestimmt. Die Beurteilung der Geeignetheit dieses Produktes für die von Ihnen anvisierte Anwendung sowie die Beurteilung der Vollständigkeit der bereitgestellten Produktdaten für diese Anwendung obliegt Ihnen bzw. Ihren technischen Abteilungen.

In diesem Produktdatenblatt werden diejenigen Merkmale beschrieben, für die wir eine liefervertragliche Gewährleistung übernehmen. Eine solche Gewährleistung richtet sich ausschließlich nach Maßgabe der im jeweiligen Liefervertrag enthaltenen Bestimmungen. Garantien jeglicher Art werden für das Produkt und dessen Eigenschaften keinesfalls übernommen.

Sollten Sie von uns Produktinformationen benötigen, die über den Inhalt dieses Produktdatenblatts hinausgehen und insbesondere eine spezifische Verwendung und den Einsatz dieses Produktes betreffen, setzen Sie sich bitte mit dem für Sie zuständigen Vertriebsbüro in Verbindung (siehe www.infineon.com). Für Interessenten halten wir Application Notes bereit.

Aufgrund der technischen Anforderungen könnte unser Produkt gesundheitsgefährdende Substanzen enthalten. Bei Rückfragen zu den in diesem Produkt jeweils enthaltenen Substanzen setzen Sie sich bitte ebenfalls mit dem für Sie zuständigen Vertriebsbüro in Verbindung.

Sollten Sie beabsichtigen, das Produkt in Anwendungen der Luftfahrt, in gesundheits- oder lebensgefährdenden oder lebenserhaltenden Anwendungsbereichen einzusetzen, bitten wir um Mitteilung. Wir weisen darauf hin, dass wir für diese Fälle

- die gemeinsame Durchführung eines Risiko- und Qualitätsassessments;
- den Abschluss von speziellen Qualitätssicherungsvereinbarungen;
- die gemeinsame Einführung von Maßnahmen zu einer laufenden Produktbeobachtung dringend empfehlen und gegebenenfalls die Belieferung von der Umsetzung solcher Maßnahmen abhängig machen.

Soweit erforderlich, bitten wir Sie, entsprechende Hinweise an Ihre Kunden zu geben.

Inhaltliche Änderungen dieses Produktdatenblatts bleiben vorbehalten.

Terms & Conditions of usage

The data contained in this product data sheet is exclusively intended for technically trained staff. You and your technical departments will have to evaluate the suitability of the product for the intended application and the completeness of the product data with respect to such application.

This product data sheet is describing the characteristics of this product for which a warranty is granted. Any such warranty is granted exclusively pursuant the terms and conditions of the supply agreement. There will be no guarantee of any kind for the product and its characteristics.

Should you require product information in excess of the data given in this product data sheet or which concerns the specific application of our product, please contact the sales office, which is responsible for you (see www.infineon.com). For those that are specifically interested we may provide application notes.

Due to technical requirements our product may contain dangerous substances. For information on the types in question please contact the sales office, which is responsible for you.

Should you intend to use the Product in aviation applications, in health or life endangering or life support applications, please notify. Please note, that for any such applications we urgently recommend

- to perform joint Risk and Quality Assessments;
- the conclusion of Quality Agreements;
- to establish joint measures of an ongoing product survey, and that we may make delivery depended on the realization of any such measures.

If and to the extent necessary, please forward equivalent notices to your customers.

Changes of this product data sheet are reserved.