



Chipsmall Limited consists of a professional team with an average of over 10 year of expertise in the distribution of electronic components. Based in Hongkong, we have already established firm and mutual-benefit business relationships with customers from,Europe,America and south Asia,supplying obsolete and hard-to-find components to meet their specific needs.

With the principle of “Quality Parts,Customers Priority,Honest Operation,and Considerate Service”,our business mainly focus on the distribution of electronic components. Line cards we deal with include Microchip,ALPS,ROHM,Xilinx,Pulse,ON,Everlight and Freescale. Main products comprise IC,Modules,Potentiometer,IC Socket,Relay,Connector.Our parts cover such applications as commercial,industrial, and automotives areas.

We are looking forward to setting up business relationship with you and hope to provide you with the best service and solution. Let us make a better world for our industry!



## Contact us

Tel: +86-755-8981 8866 Fax: +86-755-8427 6832

Email & Skype: info@chipsmall.com Web: www.chipsmall.com

Address: A1208, Overseas Decoration Building, #122 Zhenhua RD., Futian, Shenzhen, China



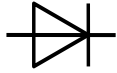

**Key Parameters**

$V_{RRM}$	2200 V
$I_{FAVM}$	4240 A ( $T_C=100\text{ }^\circ\text{C}$ )
$I_{FSM}$	88000 A
$V_{T0}$	0,668 V
$r_T$	0,083 m $\Omega$
$R_{thJC}$	8,5 K/KW
Clamping Force	36 ... 52 kN
Max. Diameter	121 mm
Contact Diameter	86 mm
Height	35 mm



For type designation please refer to actual short form catalog

<http://www.ifbip.com/catalog>

**Merkmale**

- Volle Sperrfähigkeit 50/60Hz über einen weiten Temperaturbereich
- Hohe DC Sperrstabilität
- Hohe Stoßstrombelastbarkeit
- Hermetisch dichtes Keramikgehäuse
- Hoher Gehäusebruchstrom

**Features**

- Full blocking capability 50/60Hz over a wide temperature range
- High DC blocking stability
- High surge current capability
- Hermetically sealed ceramic package
- High case non-rupture current

**Typische Anwendungen**

- Hochstrom Gleichrichter
- Gleichrichter für Antriebsapplikationen
- Kurzschliesser Applikationen

**Typical Applications**

- High-current rectifier
- Rectifier for Drives Applications
- Crowbar Applications



content of customer DMX code	DMX code digit	DMX code digit quantity
serial number	1..7	7
SP material number	8..16	9
datecode (production day)	17..18	2
datecode (production year)	19..20	2
datecode (production month)	21..22	2
vT class (optional)	23..26	4
QR class (optional)	27..30	4

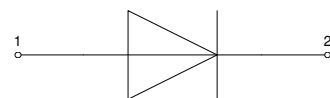

[www.ifbip.com](http://www.ifbip.com)  
[support@infineon-bip.com](mailto:support@infineon-bip.com)

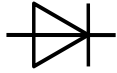

## Technische Information / technical information



**Netz-Gleichrichterdiode  
Rectifier Diode**

# D4201N

Infineon Technologies Bipolar  
GmbH & Co. KG

**Elektrische Eigenschaften / Electrical properties**  
Höchstzulässige Werte / Maximum rated values

Periodische Rückwärts-Spitzensperrspannung repetitive peak reverse voltage	$T_{vj} = -40^{\circ}\text{C} \dots T_{vj\text{ max}}$	$V_{RRM}$	1600 2000	1800 2200	V V
Durchlaßstrom-Grenzeffektivwert maximum RMS on-state current	$T_C = 100^{\circ}\text{C}$	$I_{FRMSM}$		6660	A
Dauergrenzstrom average on-state current	$T_C = 100^{\circ}\text{C}$ $T_C = 85^{\circ}\text{C}$ $T_C = 55^{\circ}\text{C}$	$I_{FAVM}$		4240 4890 6010	A A A
Stoßstrom-Grenzwert surge current	$T_{vj} = 25^{\circ}\text{C}, t_p = 10\text{ ms}$ $T_{vj} = T_{vj\text{ max}}, t_p = 10\text{ ms}$	$I_{FSM}$		88000 73500	A A
Grenzlastintegral $I^2t$ -value	$T_{vj} = 25^{\circ}\text{C}, t_p = 10\text{ ms}$ $T_{vj} = T_{vj\text{ max}}, t_p = 10\text{ ms}$	$I^2t$		38700 27000	$10^3\text{ A}^2\text{s}$ $10^3\text{ A}^2\text{s}$

**Charakteristische Werte / Characteristic values**

Durchlaßspannung on-state voltage	$T_{vj} = T_{vj\text{ max}}, i_F = 4000\text{ A}$	$v_F$	typ. max.	0,94 1,00	V V
Schleusenspannung threshold voltage	$T_{vj} = T_{vj\text{ max}}$	$V_{(TO)}$	typ. max.	0,668 0,668	V V
Ersatzwiderstand slope resistance	$T_{vj} = T_{vj\text{ max}}$	$r_T$	typ. max.	0,063 0,083	mΩ mΩ
Durchlaßkennlinie O-state characteristic  $v_F = A + B \cdot i_F + C \cdot \ln(i_F + 1) + D \cdot \sqrt{i_F}$	$T_{vj} = T_{vj\text{ max}}$		typ.  max.	A 0,6031 B -0,0000366 C -0,0312 D 0,01183  A 0,5982 B -0,0000194 C -0,0287 D 0,01133	
Rückwärts-Sperrstrom reverse current	$T_{vj} = T_{vj\text{ max}}, V_R = V_{RRM}$	$i_R$	max.	200	mA

prepared by:	TM	date of publication:	2014-06-01
approved by:	JP	revision:	6.1

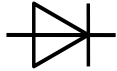

## Technische Information / technical information



**Netz-Gleichrichterdiode  
Rectifier Diode**

# D4201N

Infineon Technologies Bipolar  
GmbH & Co. KG

### Elektrische Eigenschaften / Electrical properties

Charakteristische Werte / Characteristic values

Sperrverzögerungsladung recovered charge	$V_R = 1000V, T_{vj} = T_{vj\ max}$ $C = 2,4\mu F, R = 15\Omega$ $I_{FM} = 1000A, -di_T/dt = 10 A/\mu s$	$Q_r$	max. 1,75	mAs
Rückstromspitze peak reverse recovery current	$V_R = 1000V, T_{vj} = T_{vj\ max}$ $C = 2,4\mu F, R = 15\Omega$ $I_{FM} = 1000A, -di_T/dt = 10 A/\mu s$	$I_{RM}$	max. 175	A

Sperrverzögerungsladung recovered charge	$V_R = 100V, T_{vj} = T_{vj\ max}$ $C = 2,4\mu F, R = 15\Omega$ $I_{FM} = 1000A, -di_T/dt = 10 A/\mu s$	$Q_r$	typ. 1,6	mAs
Rückstromspitze peak reverse recovery current	$V_R = 100V, T_{vj} = T_{vj\ max}$ $C = 2,4\mu F, R = 15\Omega$ $I_{FM} = 1000A, -di_T/dt = 10 A/\mu s$	$I_{RM}$	typ. 105	A

### Thermische Eigenschaften / Thermal properties

Innerer Wärmewiderstand thermal resistance, junction to case	Kühlfläche / cooling surface beidseitig / two-sided, $\theta = 180^\circ\text{sin}$ beidseitig / two-sided, DC Anode / anode, DC Kathode / cathode, DC	$R_{thJC}$	max. 9,2 max. 8,5 max. 14,9 max. 19,8	K/kW K/kW K/kW K/kW
Übergangs-Wärmewiderstand thermal resistance, case to heatsink	Kühlfläche / cooling surface beidseitig / two-sided einseitig / single-sided	$R_{thCH}$	max. 2,5 max. 5,0	K/kW K/kW
Höchstzulässige Sperrschichttemperatur maximum junction temperature		$T_{vj\ max}$	160	°C
Betriebstemperatur operating temperature		$T_{c\ op}$	-40...+160	°C
Lagertemperatur storage temperature		$T_{stg}$	-40...+160	°C

### Mechanische Eigenschaften / Mechanical properties

Gehäuse, siehe Anlage case, see annex			Seite 3 page 3	
Si-Element mit Druckkontakt Si-pellet with pressure contact				
Anpresskraft clamping force		F	36...52	kN
Gewicht weight		G	typ. 1700	g
Kriechstrecke creepage distance			40	mm
Schwingfestigkeit vibration resistance	f = 50 Hz		50	m/s <sup>2</sup>

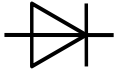

Technische Information /  
technical information



Netz-Gleichrichterdiode  
Rectifier Diode

**D4201N**

Infineon Technologies Bipolar  
GmbH & Co. KG

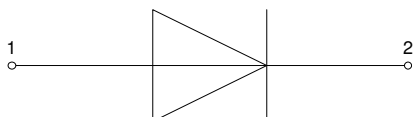
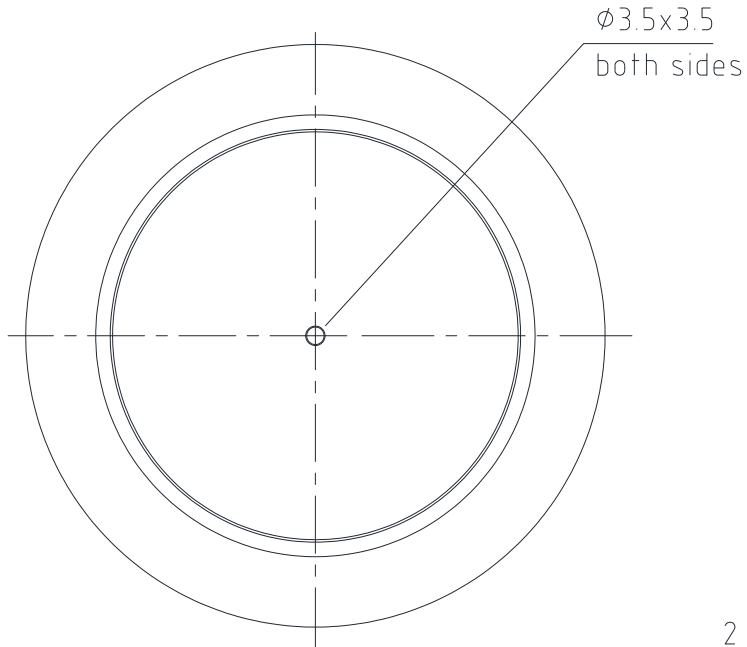
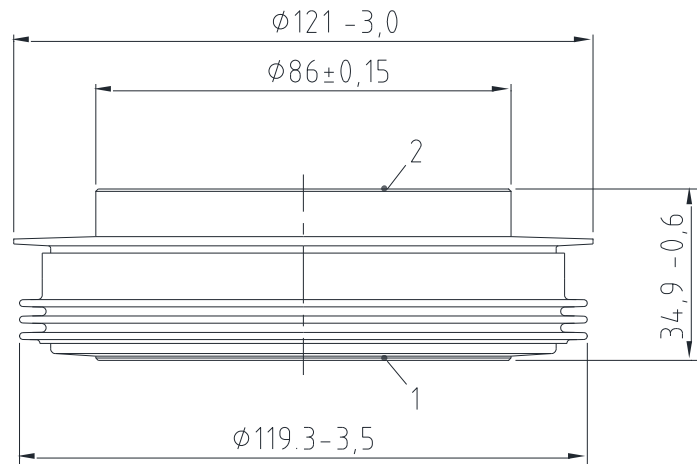

1: Anode/Anode

2: Kathode/Cathode

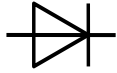

**Analytische Elemente des transienten Wärmewiderstandes  $Z_{thJC}$**   
**Analytical elements of transient thermal impedance  $Z_{thJC}$**

	Pos. n	1	2	3	4	5	6	7
beidseitig two-sided	$R_{thn}$ [K/kW]	3,2	2,78	1,58	0,76	0,18		
	$T_n$ [s]	1,472	0,186	0,049	0,0075	0,0025		
anodenseitig anode-sided	$R_{thn}$ [K/kW]	9,28	0,25	3,71	1,01	0,65		
	$T_n$ [s]	7,8	0,663	0,149	0,0244	0,00484		
kathodenseitig cathode-sided	$R_{thn}$ [K/kW]	14,33	0,13	3,24	1,36	0,74		
	$T_n$ [s]	7,7	1,205	0,18	0,035	0,0055		

Analytische Funktion / Analytical function:

$$Z_{thJC} = \sum_{n=1}^{n_{max}} R_{thn} \left( 1 - e^{-\frac{t}{\tau_n}} \right)$$

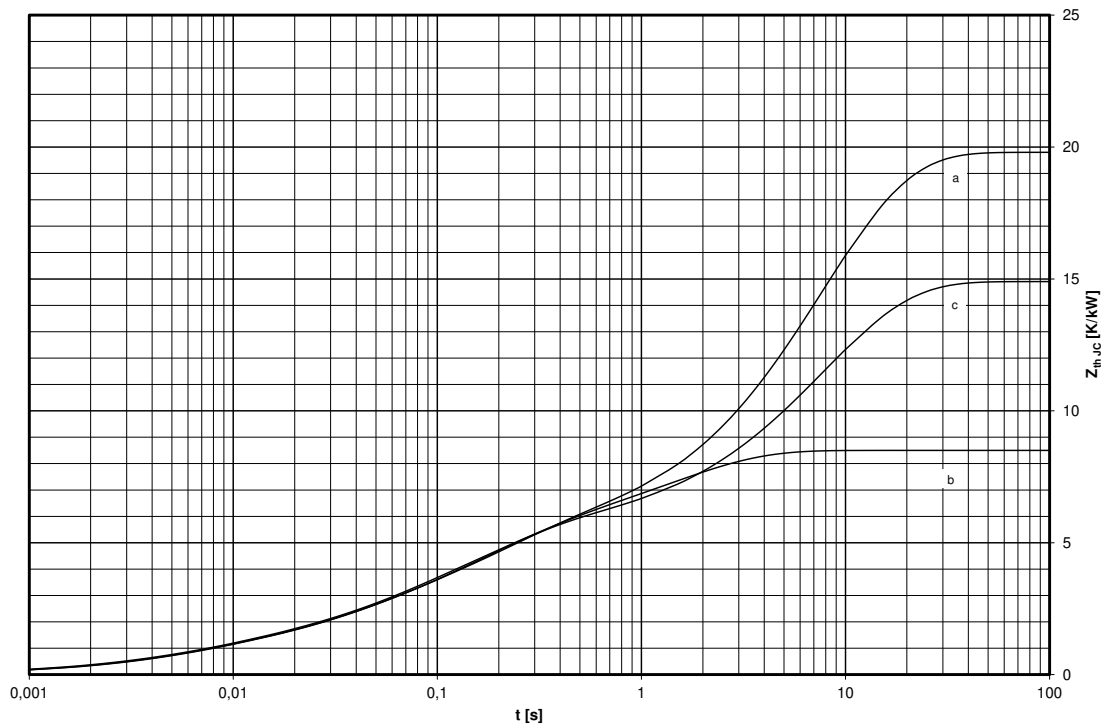

**Transienter innerer Wärmewiderstand für DC / Transient thermal impedance  $Z_{thJC} = f(t)$   
for DC**

- a** : Anodenseitige Kühlung / Anode-sided cooling
- b** : Beidseitige Kühlung / Two-sided cooling
- c** : Kathodenseitige Kühlung / Cathode-sided cooling

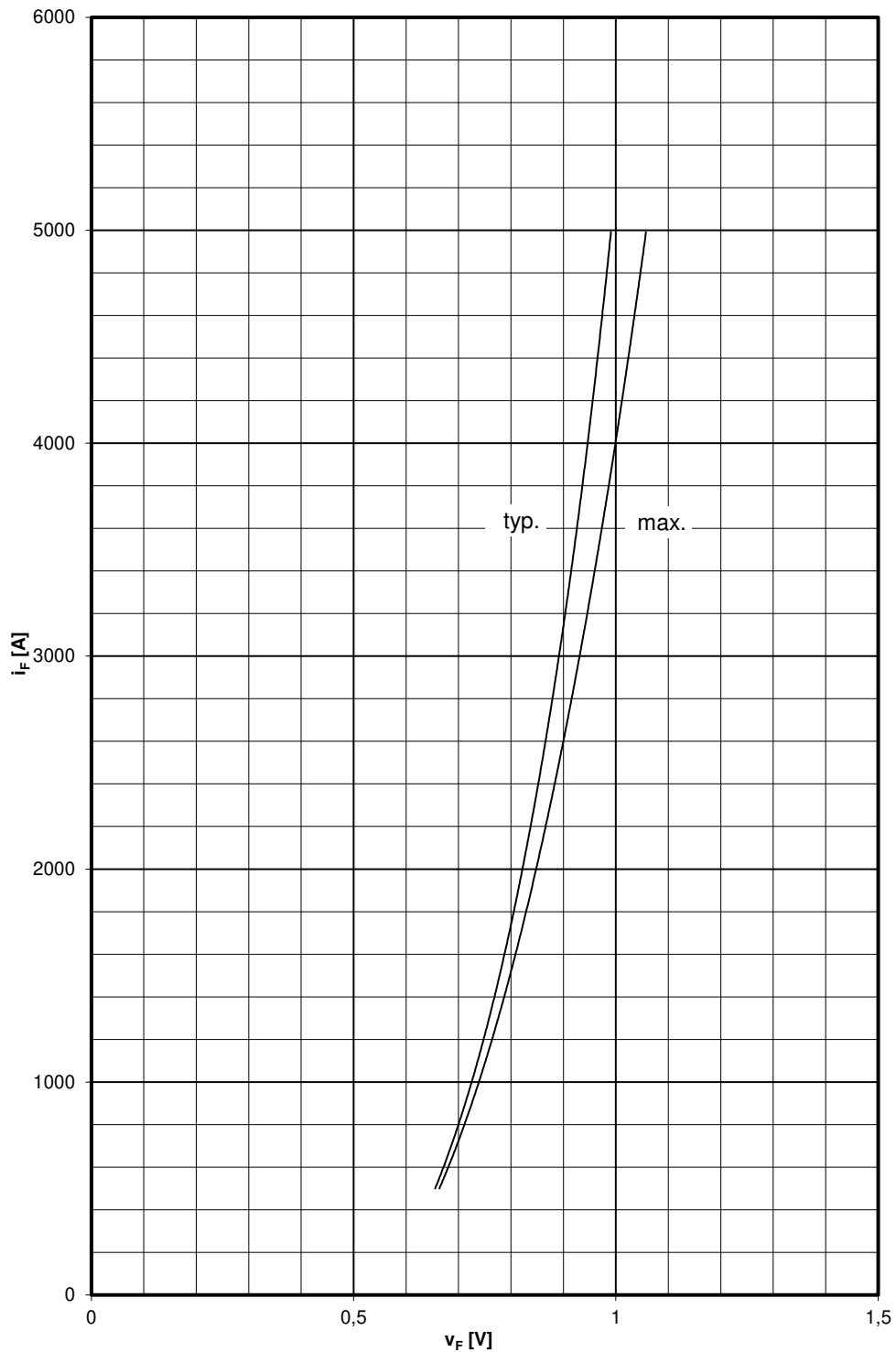
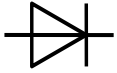

**Grenzdurchlaßkennlinie / Limiting on-state characteristic  $i_F = f(v_F)$**

$$T_{vj} = T_{vj \text{ max}}$$

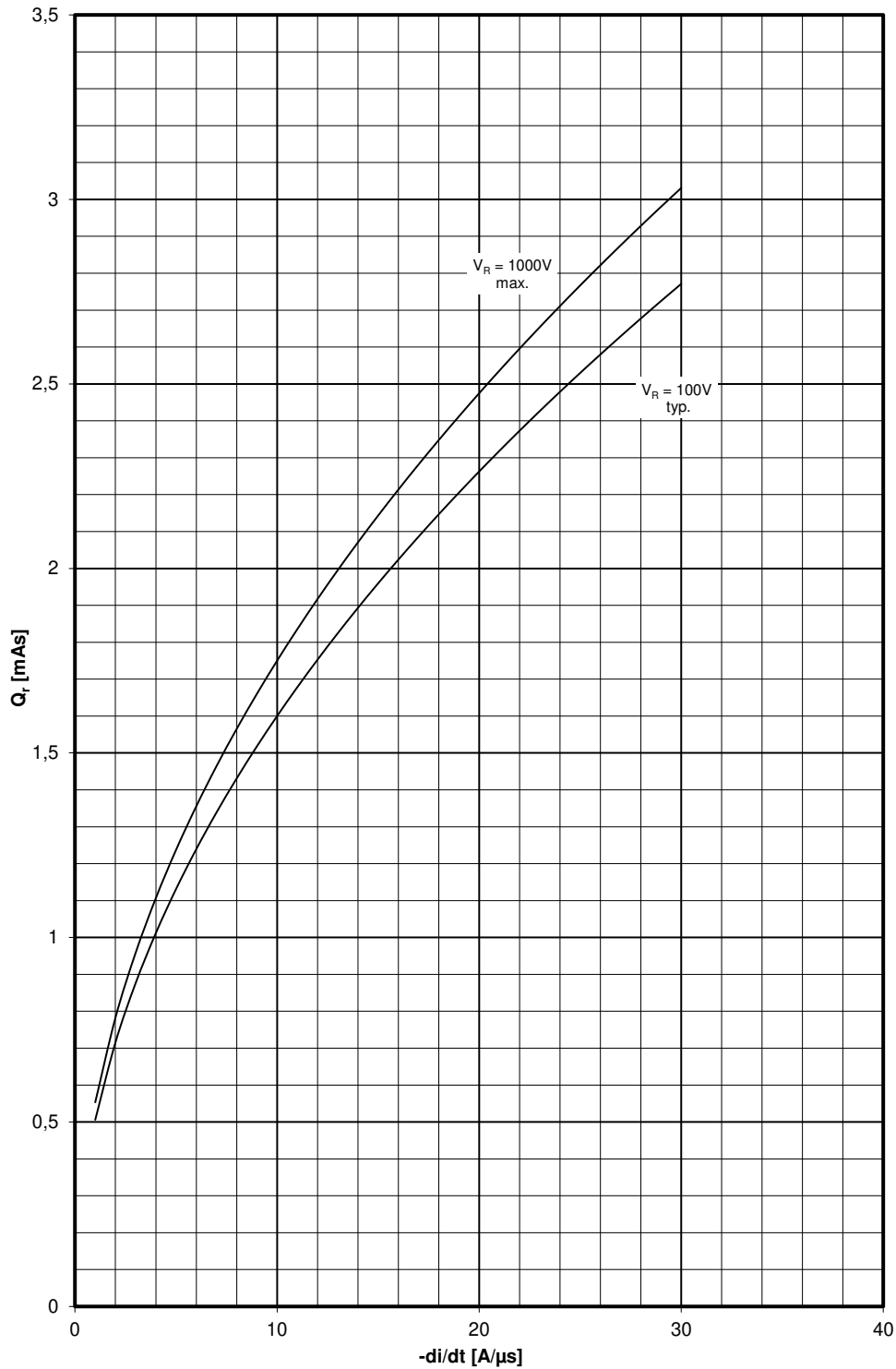
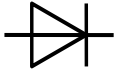

Sperrverzögerungsladung / Recovered charge  $Q_r = f(-di/dt)$

$$T_{vj} = T_{vjmax}, C = 2,4\mu F, R = 15\Omega$$



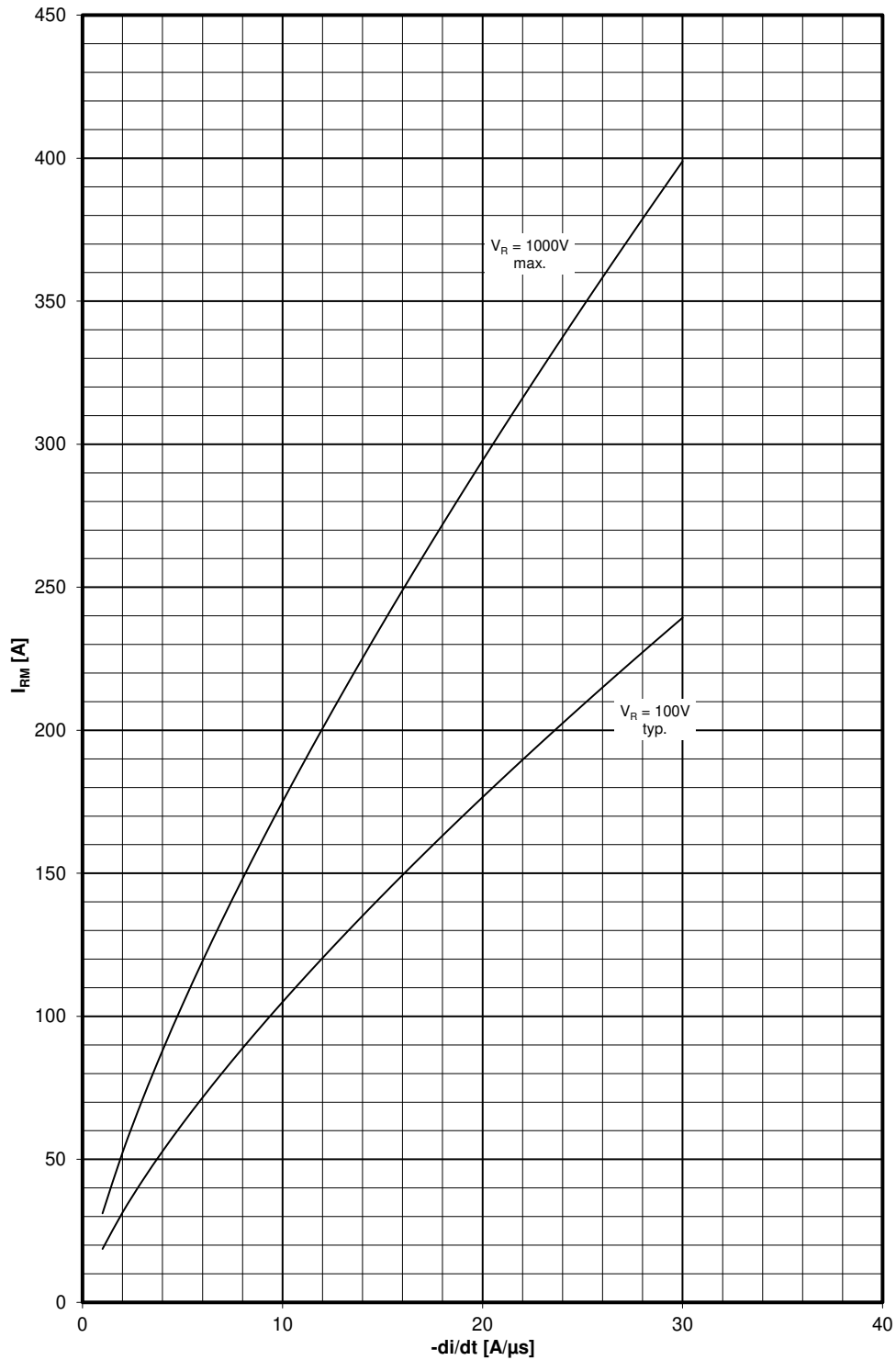
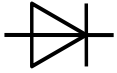

Rückstromspitze / Peak reverse recovery current  $I_{RM} = f(-di/dt)$

$$T_{vj} = T_{vjmax}, C = 2,4\mu F, R = 15\Omega$$

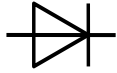

## Nutzungsbedingungen

Die in diesem Produktdatenblatt enthaltenen Daten sind ausschließlich für technisch geschultes Fachpersonal bestimmt. Die Beurteilung der Geeignetheit dieses Produktes für die von Ihnen anvisierte Anwendung sowie die Beurteilung der Vollständigkeit der bereitgestellten Produktdaten für diese Anwendung obliegt Ihnen bzw. Ihren technischen Abteilungen.

In diesem Produktdatenblatt werden diejenigen Merkmale beschrieben, für die wir eine liefervertragliche Gewährleistung übernehmen. Eine solche Gewährleistung richtet sich ausschließlich nach Maßgabe der im jeweiligen Liefervertrag enthaltenen Bestimmungen. Garantien jeglicher Art werden für das Produkt und dessen Eigenschaften keinesfalls übernommen.

Sollten Sie von uns Produktinformationen benötigen, die über den Inhalt dieses Produktdatenblatts hinausgehen und insbesondere eine spezifische Verwendung und den Einsatz dieses Produktes betreffen, setzen Sie sich bitte mit dem für Sie zuständigen Vertriebsbüro in Verbindung (siehe [www.infineon.com](http://www.infineon.com)). Für Interessenten halten wir Application Notes bereit.

Aufgrund der technischen Anforderungen könnte unser Produkt gesundheitsgefährdende Substanzen enthalten. Bei Rückfragen zu den in diesem Produkt jeweils enthaltenen Substanzen setzen Sie sich bitte ebenfalls mit dem für Sie zuständigen Vertriebsbüro in Verbindung.

Sollten Sie beabsichtigen, das Produkt in Anwendungen der Luftfahrt, in gesundheits- oder lebensgefährdenden oder lebenserhaltenden Anwendungsbereichen einzusetzen, bitten wir um Mitteilung. Wir weisen darauf hin, dass wir für diese Fälle

- die gemeinsame Durchführung eines Risiko- und Qualitätsassessments;
- den Abschluss von speziellen Qualitätssicherungsvereinbarungen;
- die gemeinsame Einführung von Maßnahmen zu einer laufenden Produktbeobachtung dringend empfehlen und gegebenenfalls die Belieferung von der Umsetzung solcher Maßnahmen abhängig machen.

Soweit erforderlich, bitten wir Sie, entsprechende Hinweise an Ihre Kunden zu geben.

Inhaltliche Änderungen dieses Produktdatenblatts bleiben vorbehalten.

## Terms & Conditions of usage

The data contained in this product data sheet is exclusively intended for technically trained staff. You and your technical departments will have to evaluate the suitability of the product for the intended application and the completeness of the product data with respect to such application.

This product data sheet is describing the characteristics of this product for which a warranty is granted. Any such warranty is granted exclusively pursuant the terms and conditions of the supply agreement. There will be no guarantee of any kind for the product and its characteristics.

Should you require product information in excess of the data given in this product data sheet or which concerns the specific application of our product, please contact the sales office, which is responsible for you (see [www.infineon.com](http://www.infineon.com)). For those that are specifically interested we may provide application notes.

Due to technical requirements our product may contain dangerous substances. For information on the types in question please contact the sales office, which is responsible for you.

Should you intend to use the Product in aviation applications, in health or life endangering or life support applications, please notify. Please note, that for any such applications we urgently recommend

- to perform joint Risk and Quality Assessments;
- the conclusion of Quality Agreements;
- to establish joint measures of an ongoing product survey, and that we may make delivery depended on the realization of any such measures.

If and to the extent necessary, please forward equivalent notices to your customers.

Changes of this product data sheet are reserved.