



Chipsmall Limited consists of a professional team with an average of over 10 year of expertise in the distribution of electronic components. Based in Hongkong, we have already established firm and mutual-benefit business relationships with customers from,Europe,America and south Asia,supplying obsolete and hard-to-find components to meet their specific needs.

With the principle of “Quality Parts,Customers Priority,Honest Operation,and Considerate Service”,our business mainly focus on the distribution of electronic components. Line cards we deal with include Microchip,ALPS,ROHM,Xilinx,Pulse,ON,Everlight and Freescale. Main products comprise IC,Modules,Potentiometer,IC Socket,Relay,Connector.Our parts cover such applications as commercial,industrial, and automotives areas.

We are looking forward to setting up business relationship with you and hope to provide you with the best service and solution. Let us make a better world for our industry!



Contact us

Tel: +86-755-8981 8866 Fax: +86-755-8427 6832

Email & Skype: info@chipsmall.com Web: www.chipsmall.com

Address: A1208, Overseas Decoration Building, #122 Zhenhua RD., Futian, Shenzhen, China



D6T

MEMS Thermal Sensors

High Sensitivity Enables Detection of Stationary Human Presence

- OMRON's unique MEMS and ASIC technology achieve a high SNR.
- Superior noise immunity with a digital output.
- High-precision area temperature detection with low cross-talk field of view characteristics.



RoHS Compliant



Refer to *Safety Precautions* on page 6.

Ordering Information

Thermal Sensors

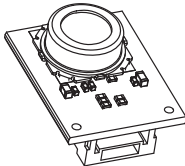
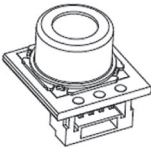
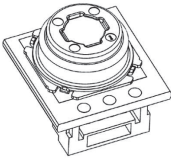
Element type	Model	Shape
4×4	D6T-44L-06	
1×8	D6T-8L-09	
1×1	D6T-1A-01	
	D6T-1A-02	

Accessories (Sold separately)

Type	Model
Cable Harness	D6T-HARNESS-02

Ratings, Specifications, and Functions

Ratings

Item	Model	D6T-44L-06	D6T-8L-09	D6T-1A-01	D6T-1A-02
Power supply voltage		4.5 to 5.5 VDC			
Storage temperature range		-10 to 60°C	-20 to 80°C	-20 to 80°C	-40 to 80°C
		(with no icing or condensation)			
Operating temperature range		0 to 50°C	0 to 60°C	0 to 60°C	-40 to 80°C
		(with no icing or condensation)			
Storage humidity range		85% max.	95% max.	95% max.	95% max.
		(with no icing or condensation)			
Operating humidity range		20% to 85%	20% to 95%	20% to 95%	20% to 95%
		(with no icing or condensation)			

Characteristics

Item	Model	D6T-44L-06	D6T-8L-09	D6T-1A-01	D6T-1A-02
View angle ^{*1}	X direction	44.2°	54.5°	58.0°	26.5°
	Y direction	45.7°	5.5°	58.0°	26.5°
Object temperature output accuracy ^{*2}	Accuracy 1	±1.5°C max. Measurement conditions: Vcc = 5.0 V (1) Tx = 25°C, Ta = 25°C (2) Tx = 45°C, Ta = 25°C (3) Tx = 45°C, Ta = 45°C			
	Accuracy 2	±3.0°C max. Measurement conditions: Vcc = 5.0 V (4) Tx = 25°C, Ta = 45°C			
Current consumption		5 mA typical		3.5 mA typical	

Functions

Item	Model	D6T-44L-06	D6T-8L-09	D6T-1A-01	D6T-1A-02
Object temperature detection range ^{*2}		5 to 50°C	5 to 50°C	5 to 50°C	-40 to 80°C
Reference temperature detection range ^{*2}		5 to 45°C	5 to 45°C	5 to 45°C	-40 to 80°C
Output specifications		Digital values that correspond to the object temperature (Tx) and reference temperature (Ta) are output from a serial communications port.			
Output form		Binary code (10 times the detected temperature (°C))			
Communications form		I2C compliant			
Temperature resolution (NETD) ^{*3}		0.06°C	0.03°C	0.02°C	0.06°C

*1. Refer to *Field of View Characteristics*.

*2. Refer to *Object Temperature Detection Range*.

*3. Reference data

Object Temperature Detection Range

D6T-44L-06, D6T-8L-09, D6T-1A-01

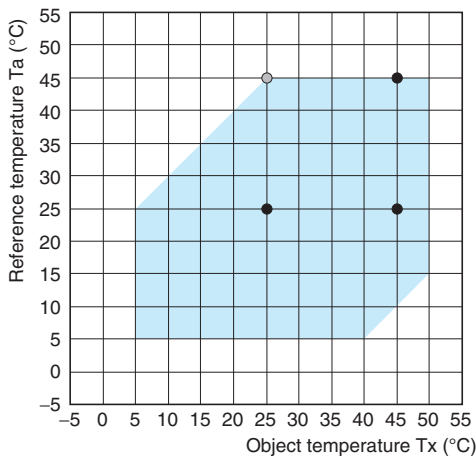

D6T-1A-02

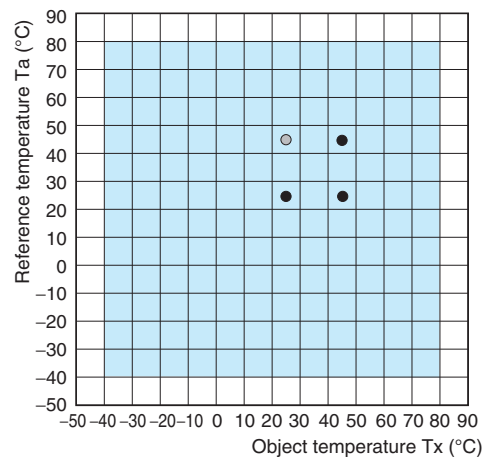

● : Inspection point for accuracy 1

○ : Inspection point for accuracy 2

■ : Object temperature detection range

Connections

Thermal Sensor Configuration Diagram

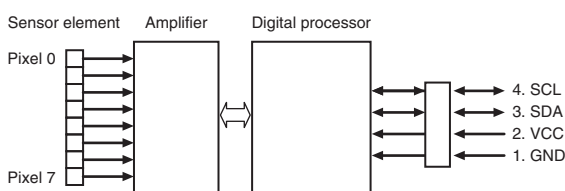

Note: The 4×4 type has pixels 0 to 15.
The 1×1 type has pixel 0.

Terminal Arrangement

Terminal	Name	Function	Remarks
1	GND	Ground	
2	VCC	Positive power supply voltage input	
3	SDA	Serial data I/O line	Connect the open-drain SDA terminal to a pull-up resistor.
4	SCL	Serial clock input	Connect the open-drain SCL terminal to a pull-up resistor.

Field of View Characteristics

D6T-44L-06

Field of view in X Direction

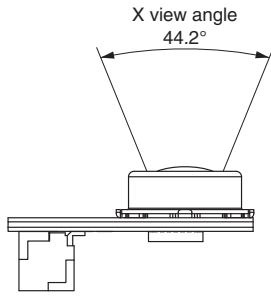

Field of view in Y Direction

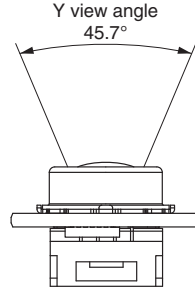

Detection Area for Each Pixel

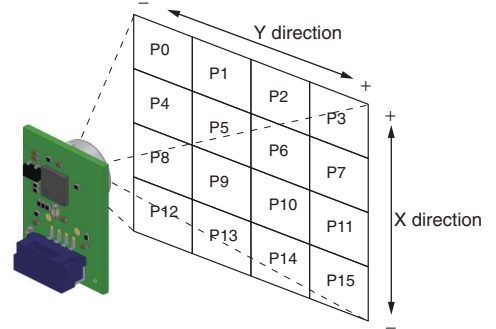

Note: Definition of view angle: Using the maximum Sensor output as a reference, the angular range where the Sensor output is 50% or higher when the angle of the Sensor is changed is defined as the view angle.

D6T-8L-09

Field of view in X Direction

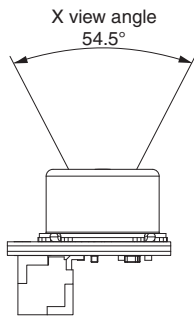

Field of view in Y Direction

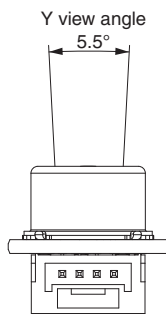

Detection Area for Each Pixel

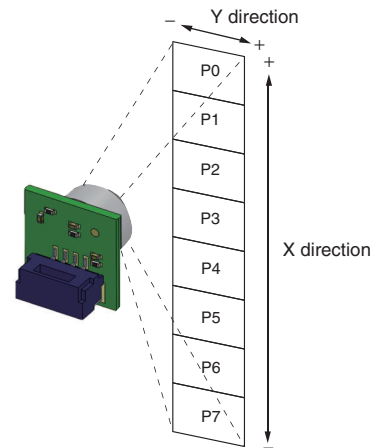

Note: Definition of view angle: Using the maximum Sensor output as a reference, the angular range where the Sensor output is 50% or higher when the angle of the Sensor is changed is defined as the view angle.

D6T-1A-01

Field of view in X Direction

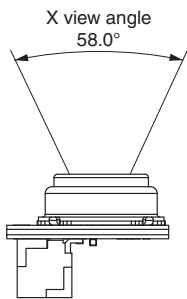

Field of view in Y Direction

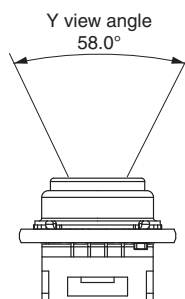

Detection Area for Each Pixel

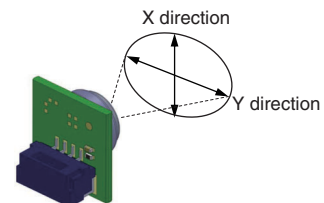

D6T-1A-02

Field of view in X Direction

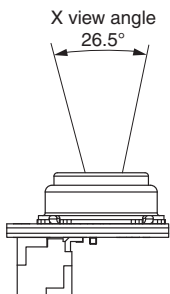

Field of view in Y Direction

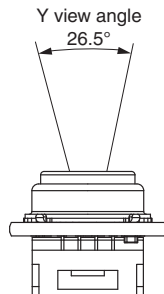

Note: Definition of view angle: Using the maximum Sensor output as a reference, the angular range where the Sensor output is 50% or higher when the angle of the Sensor is changed is defined as the view angle.

D6T

MEMS Thermal Sensors

Dimensions (Unit: mm)

D6T-44L-06

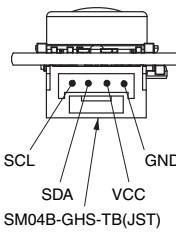
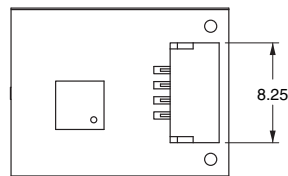
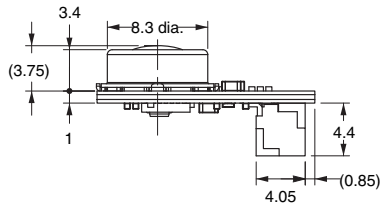
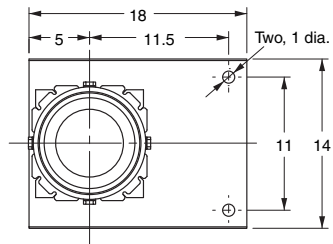
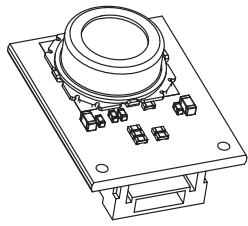

Supporting and Mounting Area (Shaded Portion)
Top View

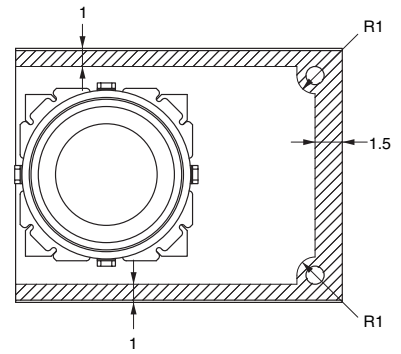

Bottom View

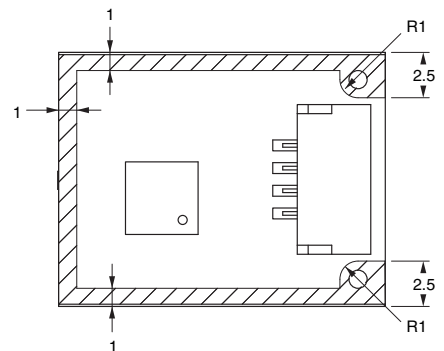

Note: Due to insulation distance limitations, do not allow metal parts to come into contact with the Sensor.

D6T-8L-09

D6T

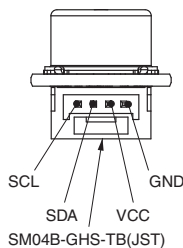
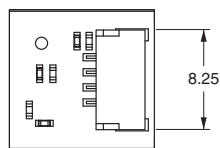
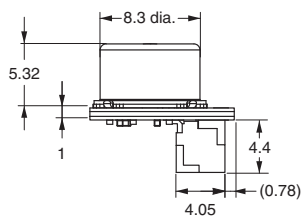
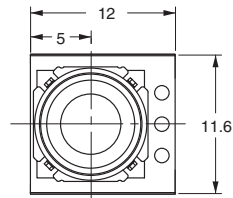
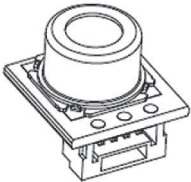

Supporting and Mounting Area (Shaded Portion)
Top View

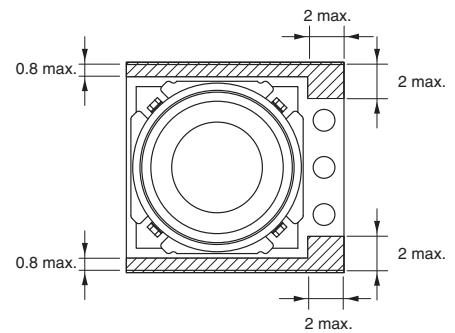

Bottom View

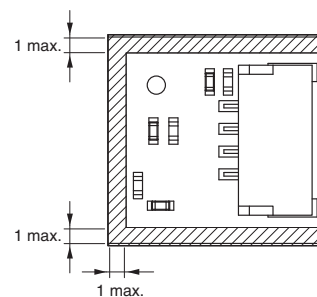

Note: Due to insulation distance limitations, do not allow metal parts to come into contact with the Sensor.

Note: Unless otherwise specified, a tolerance of ± 0.3 mm applies to all dimensions.

D6T-1A-01 D6T-1A-02

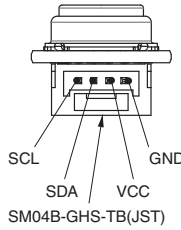
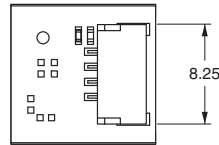
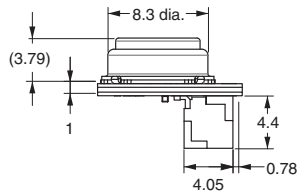
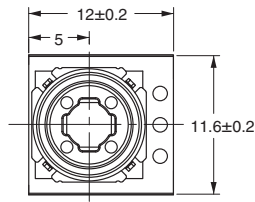
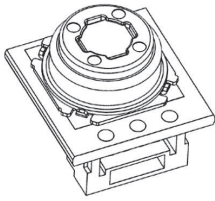

Supporting and Mounting Area (Shaded Portion) Top View

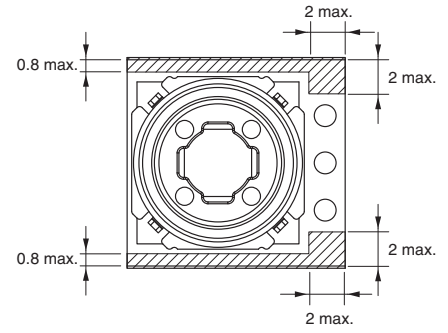

Bottom View

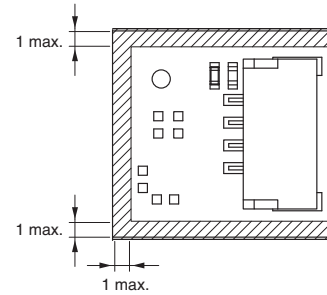

Note: Due to insulation distance limitations, do not allow metal parts to come into contact with the Sensor.

D6T-HARNESS-02 (Optional - sold separately)

Cable Color

GND → BLACK Wire
VCC → RED Wire
SDA → BLUE Wire
SCL → YELLOW Wire

* Length of Cable removed sheath.

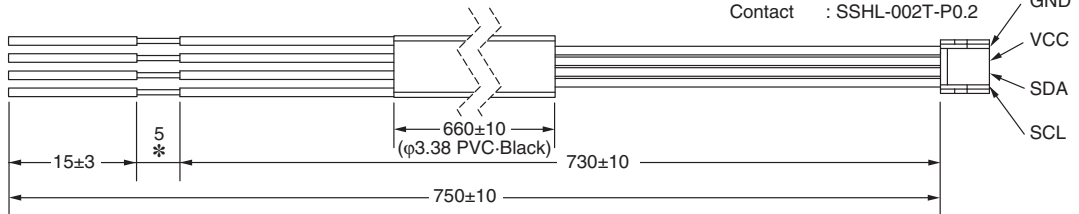

Cable :UL1061.AWG#28
UL Tube : T-105-2 No.8
Connector : GHR-04V-S
Contact : SSSL-002T-P0.2

Note: Unless otherwise specified, a tolerance of ± 0.3 mm applies to all dimensions.

Safety Precautions

Precautions for Correct Use

● Installation

- The Sensor may not achieve the characteristics given in this datasheet due to the ambient environment or installation location. Before using the Sensor, please acquire an adequate understanding and make a prior assessment of Sensor characteristics in your actual system.

● Operating Environment

- Do not use the Sensor in locations where dust, dirt, oil, and other foreign matter will adhere to the lens. This may prevent correct temperature measurements.
- Do not use the Sensor in any of the following locations.
 - Locations where the Sensor may come into contact with water or oil
 - Outdoors
 - Locations subject to direct sunlight.
 - Locations subject to corrosive gases (in particular, chloride, sulfide, or ammonia gases).
 - Locations subject to extreme temperature changes
 - Locations subject to icing or condensation.
 - Locations subject to excessive vibration or shock.

● Noise Countermeasures

- The Sensor does not contain any protective circuits. Never subject it to an electrical load that exceeds the absolute maximum ratings for even an instance. The circuits may be damaged. Install protective circuits as required so that the absolute maximum ratings are not exceeded.
- Keep as much space as possible between the Sensor and devices that generates high frequencies (such as high-frequency welders and high-frequency sewing machines) or surges.
- Attach a surge protector or noise filter on nearby noise-generating devices (in particular, motors, transformers, solenoids, magnetic coils, or devices that have an inductance component).
- In order to prevent inductive noise, separate the connector of the Sensor from power lines carrying high voltages or large currents. Using a shielded line is also effective.
- If a switching regulator is used, check that malfunctions will not occur due to switching noise from the power supply.

● Handling

- This Sensor is a precision device. Do not drop it or subject it to excessive shock or force. Doing so may damage the Sensor or change its characteristics. Never subject the connector to unnecessary force. Do not use a Sensor that has been dropped.
- Take countermeasures against static electricity before you handle the Sensor.
- Turn OFF the power supply to the system before you install the Sensor. Working with the Sensor while the power supply is turned ON may cause malfunctions.
- Secure the Sensor firmly so that the optical axis does not move.
- Install the Sensor on a flat surface. If the installation surface is not even, the Sensor may be deformed, preventing correct measurements.
- Do not install the Sensor with screws. Screws may cause the resist to peel from the board. Secure the Sensor in a way that will not cause the resist to peel.
- Always check operation after you install the Sensor.
- Use the specified connector (GHR-04 from JST) and connect it securely so that it will not come off. If you solder directly to the connector terminals, the Sensor may be damaged.
- Make sure to wire the polarity of the terminals correctly. Incorrect polarity may damage the Sensor.
- Never attempt to disassemble the Sensor.
- Do not use the cable harness to the other product.

MEMO

- Application examples provided in this document are for reference only. In actual applications, confirm equipment functions and safety before using the product.
- Consult your OMRON representative before using the product under conditions which are not described in the manual or applying the product to nuclear control systems, railroad systems, aviation systems, vehicles, combustion systems, medical equipment, amusement machines, safety equipment, and other systems or equipment that may have a serious influence on lives and property if used improperly. Make sure that the ratings and performance characteristics of the product provide a margin of safety for the system or equipment, and be sure to provide the system or equipment with double safety mechanisms.

Note: Do not use this document to operate the Unit.