



Chipsmall Limited consists of a professional team with an average of over 10 year of expertise in the distribution of electronic components. Based in Hongkong, we have already established firm and mutual-benefit business relationships with customers from,Europe,America and south Asia,supplying obsolete and hard-to-find components to meet their specific needs.

With the principle of “Quality Parts,Customers Priority,Honest Operation,and Considerate Service”,our business mainly focus on the distribution of electronic components. Line cards we deal with include Microchip,ALPS,ROHM,Xilinx,Pulse,ON,Everlight and Freescale. Main products comprise IC,Modules,Potentiometer,IC Socket,Relay,Connector.Our parts cover such applications as commercial,industrial, and automotives areas.

We are looking forward to setting up business relationship with you and hope to provide you with the best service and solution. Let us make a better world for our industry!



## Contact us

Tel: +86-755-8981 8866 Fax: +86-755-8427 6832

Email & Skype: info@chipsmall.com Web: www.chipsmall.com

Address: A1208, Overseas Decoration Building, #122 Zhenhua RD., Futian, Shenzhen, China



# DA Series Miniature Single Pole Rocker Switches

## Features/Benefits

- Nice actuator styling with multiple options
- Guards to prevent accidental actuation
- Momentary and maintained functions
- IP65 splash proof rubber boot option
- RoHS compliant

## Typical Applications

- Small appliances
- Computers and peripherals
- Medical instrumentation



**UL** US UL 61058-1

## Specifications

### CONTACT RATING:

- 16 AMPS @ 125 VAC, 1/3 HP;
- 10 AMPS @ 250 VAC, 1/2 HP.
- 10 AMPS @ 125 VAC, 6 AMPS @ 250 VAC.

ELECTRICAL LIFE: 10,000 make and break cycles at full load.

INSULATION RESISTANCE:  $10^8 \Omega$  min.

DIELECTRIC STRENGTH: 1,500 VRMS @ sea level.

OPERATING TEMPERATURE: -20°C to +85°C

## Materials

HOUSING AND ACTUATOR: 6/6 nylon (UL94V-2), black, matte finish.

ILLUMINATED ACTUATOR: Polycarbonate, matte finish.

CENTER CONTACTS: Silver plated, copper alloy.

END CONTACTS: Silver plated.

ALL TERMINALS: Silver plated, copper alloy.

**NOTE:** Specifications and materials listed above are for switches with standard options. For information on specific and custom switches, consult Customer Service Center.

## Build-A-Switch

To order, simply select desired option from each category and place in the appropriate box. Available options are shown and described on pages G-57 through G-59. For additional options not shown in catalog, consult Customer Service Center.



### Switch Function

- DA101** SPDT On-None-On
- DA102** SPST On-None-Off
- DA103** SPDT On-Off-On

### Actuator

- J1** Rocker
- J2** Two-tone rocker
- \*, \*\*J3** Illuminated rocker
- \*\*J4** Circle, illuminated rocker
- \*\*J5** Oval, illuminated rocker

### Actuator Color

- 1-5** See Chart on Page G-59
- \*R** Red, illuminated
- \*A** Amber, illuminated
- \*G** Green, illuminated

\* Actuator "J3" illuminated switches are not available with actuator markings

\*\* Actuator "J3", "J4" and "J5" are not available with Termination option "17" solder lug

### Mounting Style/Color

- S2** Snap-in, black
- S1** Snap-in, white
- B2** Recessed snap-in bracket, black
- G2** Guard, black

### Termination

- 15** .187" quick connect
- 17** Solder lug
- 02** Thru-hole
- A** Right angle

### Actuator Marking

- (NONE)** No marking
- D** ON-OFF
- H** "O I" - international ON-OFF
- N** Large dot
- P** "O -" international ON-OFF

### Contact Rating

- QF** Silver

### Lamp Rating

- (NONE)** No lamp
- 6** LED
- 7** 125 VAC neon
- 8** 250 VAC neon

Rocker

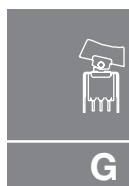

**C&K**

Dimensions are shown: Inches (mm)  
Specifications and dimensions subject to change

# DA Series Miniature Single Pole Rocker Switches

## SWITCH FUNCTION

NO. POLES	MODEL NO.	SWITCH FUNCTION			CONNECTED TERMINALS			SCHEMATIC
		C&K marking on opposite side			C&K marking on opposite side			
SP	DA101	ON	NONE	ON	2-3	N/A	2-1	
	DA102	ON	NONE	OFF				 OR For 7 & 8 Illuminated Versions Only
	DA103	ON	OFF	ON				For 6 Illuminated Versions Only

Shown in Pos. 1

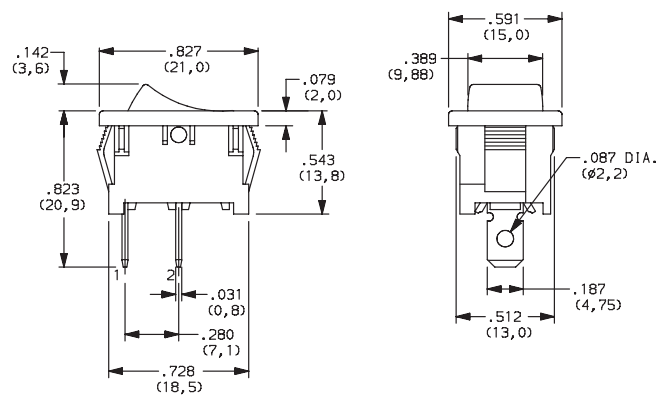

## ACTUATOR

- J1 ROCKER
- \*J3 ILLUMINATED ROCKER

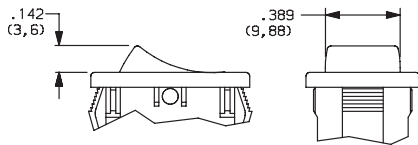

**NOTE:** J3 actuator available with DA102 switch functions, 7&8 lamp ratings and not available with O2 and A termination options.

\* J3 actuator not available with markings or Termination option "17" solder lug

- J2 TWO-TONE ROCKER

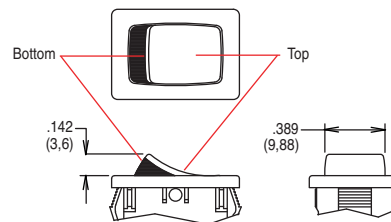

**NOTE:**

1. Available with DA102 switch function only.
2. Available with None or P actuator marking options only.



Dimensions are shown: Inches (mm)  
Specifications and dimensions subject to change



# DA Series Miniature Single Pole Rocker Switches

## ACTUATOR

### J4 CIRCLE, ILLUMINATED ROCKER

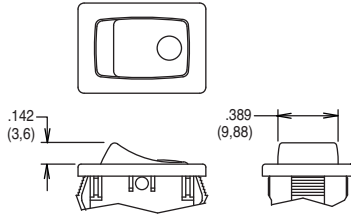

**NOTE:** Available with DA102 switch function and 7 & 8 lamp ratings combinations only. Not available with O2 and A termination options. \* J4 actuator not available with Termination option "17" solder lug

### J5 OVAL, ILLUMINATED ROCKER

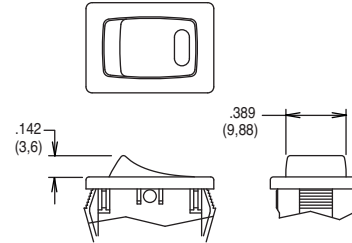

**NOTE:** Available with DA102 switch function and 6 lamp rating combinations only. Not available with O2 and A termination options. \* J5 actuator not available with Termination option "17" solder lug

## ACTUATOR COLOR

	OPTION CODE	ACTUATOR COLOR
<b>J1 only</b>	<b>2</b>	BLACK
	<b>1</b>	WHITE
	<b>3</b>	RED
<b>J3, J4, J5 only</b>	<b>R</b>	RED, ILLUMINATED
	<b>A</b>	AMBER, ILLUMINATED
	<b>G</b>	GREEN, ILLUMINATED

	OPTION CODE	ACTUATOR COLOR	
		TOP	BOTTOM
<b>J2 only</b>	<b>1</b>	WHITE	RED
	<b>2</b>	WHITE	BLACK
	<b>3</b>	RED	WHITE
	<b>4</b>	BLACK	WHITE
	<b>5</b>	BLACK	RED

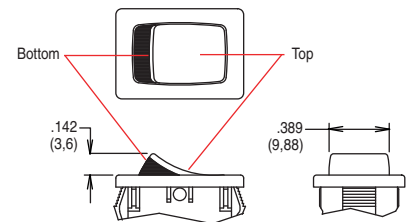

## MOUNTING STYLE/COLOR

### S2 SNAP-IN, BLACK

### S1 SNAP-IN, WHITE

### G2 GUARD, BLACK

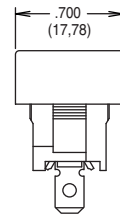
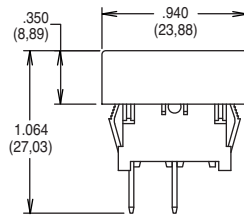
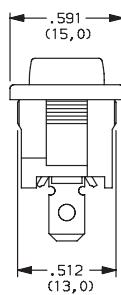
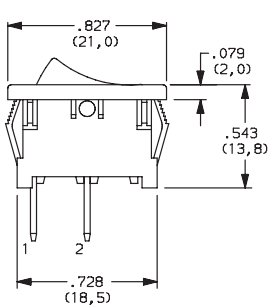

### S2, S1 & G2 PANEL MOUNTING

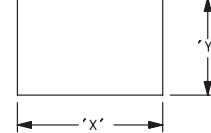

PANEL THICKNESS	"X"	"Y"
0.030-0.049 (0,75-1,25)	0.756-.004 (19,2-0,1)	0.512+.004 (13,0+0,1)
0.049-0.079 (1,25-2,0)	0.764-.004 (19,4-0,1)	0.512+.004 (13,0+0,1)
0.079-0.118 (2,0-3,0)	0.779-.004 (19,8-0,1)	0.512+.004 (13,0+0,1)

**NOTE:** Available with DA10X switch functions only.

Actuator shown in Pos. 1

### B2 RECESSED SNAP-IN BRACKET, BLACK

### B2 PANEL MOUNTING

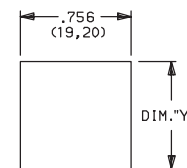
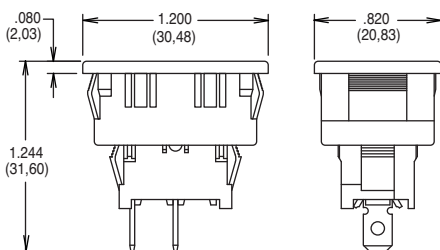

PANEL THICKNESS	"Y"
0.030-0.049 (0,75-0,25)	1.068 (27,13)
0.049-0.079 (1,25-2,0)	1.076 (27,33)
0.079-0.118 (2,0-3,0)	1.092 (27,74)

**NOTE:** Available with DA10X switch functions only.

Rocker



G

**C&K**



Third Angle Projection

Dimensions are shown: Inches (mm)  
Specifications and dimensions subject to change

# DA Series Miniature Single Pole Rocker Switches

## TERMINATION

### 15 .187" QUICK CONNECT

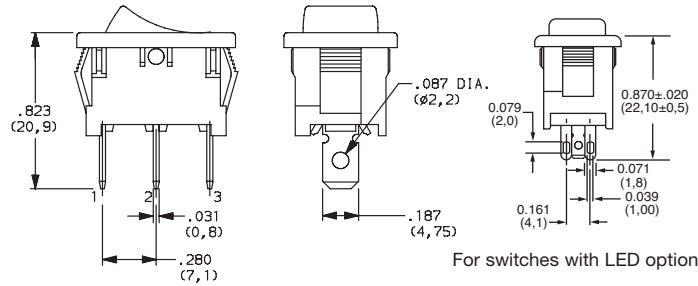

### 17 SOLDER LUG

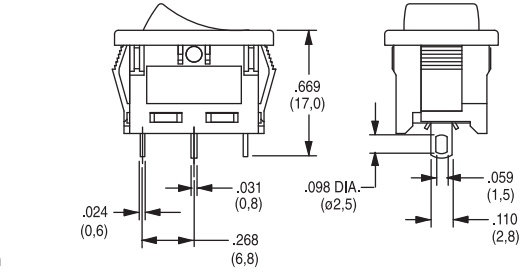

### 02\* THRU-HOLE

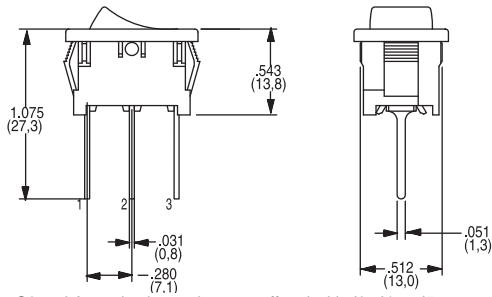

### A\* RIGHT ANGLE

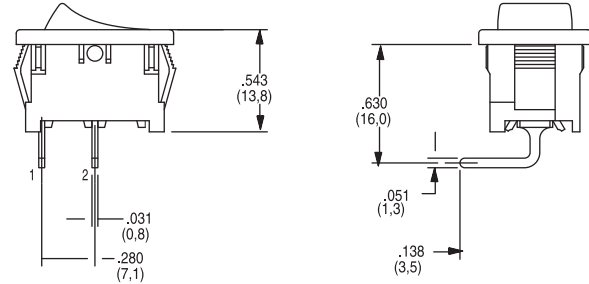

\* NOTE - O2 and A termination options not offered with J3, J4 or J5 actuator options.

## ACTUATOR MARKING

### NONE NO MARKING



### D ON-OFF



### H O I



### N LARGE DOT



### P O -

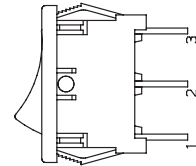
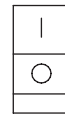

All models shown in Pos. 1  
Markings not available with J3 actuator

NOTE: Orientation of actuator marking and terminals.

## CONTACT MATERIAL

OPTION CODE	CONTACT AND TERMINAL MATERIAL	RATINGS	
QF	SILVER	POWER	16 AMPS @ 125 VAC; 1/3 HP; 10 AMPS @ 250 VAC; 1/2 10 AMPS @ 125 VAC, 6 AMPS @ 250 VAC

\* Note: See Technical Data section of this catalog for RoHS compliant and compatible definitions and specifications.

## LAMP RATING

(NONE) NO LAMP

6 LED RATING @ 10 mA  $V_f=1.85V$

7 125 VAC 33kΩ NEON

8 250 VAC 150kΩ NEON

## ACCESSORIES

216C0000 IP65 SPLASH PROOF RUBBER BOOT

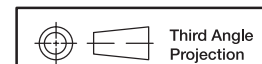
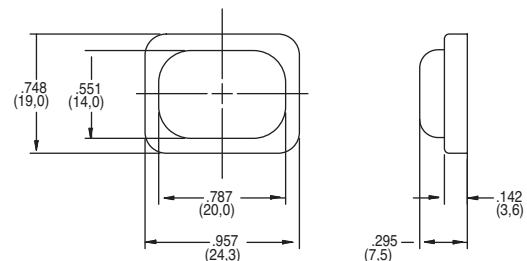

Third Angle Projection  
Dimensions are shown: Inches (mm)  
Specifications and dimensions subject to change

**C&K**

