



Chipsmall Limited consists of a professional team with an average of over 10 year of expertise in the distribution of electronic components. Based in Hongkong, we have already established firm and mutual-benefit business relationships with customers from,Europe,America and south Asia,supplying obsolete and hard-to-find components to meet their specific needs.

With the principle of "Quality Parts,Customers Priority,Honest Operation,and Considerate Service",our business mainly focus on the distribution of electronic components. Line cards we deal with include Microchip,ALPS,ROHM,Xilinx,Pulse,ON,Everlight and Freescale. Main products comprise IC,Modules,Potentiometer,IC Socket,Relay,Connector.Our parts cover such applications as commercial,industrial, and automotives areas.

We are looking forward to setting up business relationship with you and hope to provide you with the best service and solution. Let us make a better world for our industry!



## Contact us

Tel: +86-755-8981 8866 Fax: +86-755-8427 6832

Email & Skype: info@chipsmall.com Web: www.chipsmall.com

Address: A1208, Overseas Decoration Building, #122 Zhenhua RD., Futian, Shenzhen, China



## DC025 Triple Output-Series Power Modules: 18 Vdc to 36 Vdc Input; 25 W



The DC025 Triple Output-Series Power Modules use advanced, surface-mount technology and deliver high-quality, compact, dc-dc conversion at an economical price.

### Features

- Small size: 71.1 mm x 61.0 mm x 12.7 mm (2.80 in. x 2.40 in. x 0.50 in.)
- Low output noise
- Industry-standard pinout
- Metal case with separate case ground pin
- 2:1 input voltage range
- Remote on/off (positive logic)
- *UL*\* Recognized, *CSA*† Certified, and VDE Licensed
- Within FCC and CISPR Class A Radiated Limits

### Applications

- Distributed power architectures
- Telecommunications

### Options

- Higher accuracy output voltage clamp set point
- Short pins: 2.79 mm ± 0.25 mm (0.110 in. ± 0.010 in.)
- Heat sink available for extended operation
- Negative logic remote on/off

### Description

The DC025 Triple Output-Series Power Modules are dc-dc converters that operate over an input voltage range of 18 Vdc to 36 Vdc and provide three outputs. These modules offer extremely low noise levels with industry-standard pinouts in a small footprint. Each highly reliable and efficient unit features remote on/off and current limit.

The maximum total output power of the DC025 Triple Output-Series Power Modules is limited to 25 W. The main output ( $V_{O1}$ ) is designed to deliver the entire 25 W. The auxiliary outputs ( $V_{O2}$  and  $V_{O3}$ ) can provide a total of 22.5 W as long as the total output power does not exceed 25 W.

Efficiency greater than 80%, a wide operating temperature range, and a metal case are additional features of these modules.

\* *UL* is a registered trademark of Underwriters Laboratories, Inc.  
† *CSA* is a registered trademark of Canadian Standards Association.

## Absolute Maximum Ratings

Stresses in excess of the absolute maximum ratings can cause permanent damage to the device. These are absolute stress ratings only. Functional operation of the device is not implied at these or any other conditions in excess of those given in the operations sections of the data sheet. Exposure to absolute maximum ratings for extended periods can adversely affect device reliability.

Parameter	Symbol	Min	Max	Unit
Input Voltage Continuous	$V_I$	—	50	V
I/O Isolation Voltage:				
dc	—	—	500	V
Transient (1 minute)	—	—	850	V
Operating Case Temperature	$T_C$	-40	100	°C
Storage Temperature	$T_{stg}$	-55	125	°C

## Electrical Specifications

Unless otherwise indicated, specifications apply to all modules over all operating input voltage, resistive load, and temperature conditions.

**Table 1. Input Specifications**

Parameter	Symbol	Min	Typ	Max	Unit
Operating Input Voltage	$V_I$	18	28	36	Vdc
Maximum Input Current ( $V_I = 0$ V to 36 V; $I_O = I_{O,max}$ ; see Figure 1.)	$I_{I,max}$	—	—	3.0	A
Inrush Transient	$i^2t$	—	—	0.2	A <sup>2</sup> s
Input Reflected-ripple Current, Peak-to-peak (5 Hz to 20 MHz, 12 $\mu$ H source impedance; $T_C = 25$ °C; see Figure 18 and Design Considerations section.)	—	—	30	—	mAp-p
Input Ripple Rejection (120 Hz)	—	—	60	—	dB

## Fusing Considerations

**CAUTION: This power module is not internally fused. An input line fuse must always be used.**

This encapsulated power module can be used in a wide variety of applications, ranging from simple stand-alone operation to an integrated part of a sophisticated power architecture. To preserve maximum flexibility, internal fusing is not included; however, to achieve maximum safety and system protection, always use an input line fuse. The safety agencies require a normal-blow, dc fuse with a maximum rating of 5 A in series with the ungrounded input lead. Based on the information provided in this data sheet on inrush energy and maximum dc input current, the same type of fuse with a lower rating can be used. Refer to the fuse manufacturer's data for further information.

**Electrical Specifications** (continued)

**Table 2. Output Specifications**

Parameter	Device	Symbol	Min	Typ	Max	Unit
Output Voltage (Over all operating input voltage, resistive load, and temperature conditions until end of life. See Figure 20.)	DC025ABK-M	V <sub>O1</sub>	4.80	—	5.20	Vdc
		V <sub>O2</sub>	10.80	—	13.70	Vdc
		V <sub>O3</sub>	-10.80	—	-13.70	Vdc
	DC025ACL-M	V <sub>O1</sub>	4.80	—	5.20	Vdc
		V <sub>O2</sub>	13.77	—	17.20	Vdc
		V <sub>O3</sub>	-13.77	—	-17.20	Vdc
Output Voltage Set Point (V <sub>I</sub> = 28 V; T <sub>C</sub> = 25 °C; I <sub>O1</sub> = 2.0 A, I <sub>O2</sub> = I <sub>O3</sub> = 0.5 A)	DC025ABK-M	V <sub>O1, set</sub>	4.90	5.00	5.10	Vdc
		V <sub>O2, set</sub>	11.83	12.20	12.57	Vdc
		V <sub>O3, set</sub>	-11.83	-12.20	-12.57	Vdc
	DC025ACL-M	V <sub>O1, set</sub>	4.90	5.00	5.10	Vdc
		V <sub>O2, set</sub>	14.84	15.30	15.76	Vdc
		V <sub>O3, set</sub>	-14.84	-15.30	-15.76	Vdc
Output Regulation: Line (V <sub>I</sub> = 18 V to 36 V) Load (See Figures 5—8.) (I <sub>O1</sub> = I <sub>O, min</sub> to I <sub>O, max</sub> , I <sub>O2</sub> = I <sub>O3</sub> = I <sub>O, min</sub> ) Temperature (See Figures 2—4.) (T <sub>C</sub> = -40 °C to +100 °C)	All	—	—	0.1	0.2	%
	All	V <sub>O1</sub>	—	0.1	0.2	%
	All	V <sub>O1</sub>	—	0.5	1.5	%
Output Ripple and Noise (See Figure 19.): RMS  Peak-to-peak (5 Hz to 20 MHz)	All	V <sub>O1</sub>	—	—	25	mVrms
		V <sub>O2, V<sub>O3</sub></sub>	—	—	30	mVrms
	All	V <sub>O1</sub>	—	—	100	mVp-p
		V <sub>O2, V<sub>O3</sub></sub>	—	—	150	mVp-p
Output Current (At I <sub>O</sub> < I <sub>O, min</sub> , the modules may exceed output ripple specifications.)	DC025ABK-M	I <sub>O1</sub>	0.5	—	5.0	A
		I <sub>O2, I<sub>O3</sub></sub>	0.1	—	1.0	A
	DC025ACL-M	I <sub>O1</sub>	0.5	—	5.0	A
		I <sub>O2, I<sub>O3</sub></sub>	0.1	—	0.83	A
Output Current-limit Inception (V <sub>O</sub> = 90% of V <sub>O, nom</sub> and minimum load on other outputs. See Figures 9—12.)	DC025ABK-M	I <sub>O1</sub>	—	6	7.5	A
		I <sub>O2, I<sub>O3</sub></sub>	—	2	3.0	A
	DC025ACL-M	I <sub>O1</sub>	—	6	7.5	A
		I <sub>O2, I<sub>O3</sub></sub>	—	2	3.0	A
Output Short-circuit Current (V <sub>O</sub> = 1 V and minimum load on other outputs.)	DC025ABK-M	I <sub>O1</sub>	—	8	10.5	A
		I <sub>O2, I<sub>O3</sub></sub>	—	3	4.5	A
	DC025ACL-M	I <sub>O1</sub>	—	8	10.5	A
		I <sub>O2, I<sub>O3</sub></sub>	—	3	4.5	A
Efficiency (V <sub>I</sub> = 28 V; T <sub>C</sub> = 25 °C; see Figures 13, 14, and 20.): I <sub>O1</sub> = 2.5 A, I <sub>O2</sub> = I <sub>O3</sub> = 0.5 A I <sub>O1</sub> = 2.0 A, I <sub>O2</sub> = I <sub>O3</sub> = 0.5 A	DC025ABK-M	η	79	82	—	%
		DC025ACL-M	η	79	82	—

**Electrical Specifications** (continued)

**Table 2. Output Specifications** (continued)

Parameter	Device	Symbol	Min	Typ	Max	Unit
Dynamic Response ( $\dot{I}_o/\dot{I}_t = 1 \text{ A}/10 \mu\text{s}$ , $V_I = 28 \text{ V}$ , $T_C = 25 \text{ }^\circ\text{C}$ ):						
Load Change from $I_o = 50\%$ to $75\%$ of $I_{o, \text{max}}$ :						
Peak Deviation	All	$V_{O1}$	—	80	—	mV
Settling Time ( $V_o < 10\%$ peak deviation)	All	—	—	1	—	ms
Load Change from $I_o = 50\%$ to $25\%$ of $I_{o, \text{max}}$ :						
Peak Deviation	All	$V_{O1}$	—	80	—	mV
Settling Time ( $V_o < 10\%$ peak deviation)	All	—	—	0.5	—	ms

**Table 3. Isolation Specifications**

Parameter	Min	Typ	Max	Unit
Isolation Capacitance	—	0.02	—	$\mu\text{F}$
Isolation Resistance	10	—	—	$\text{M}\Omega$

**General Specifications**

Parameter	Min	Typ	Max	Unit
Calculated MTBF ( $I_o = 80\%$ of $I_{o, \text{max}}$ ; $T_C = 40 \text{ }^\circ\text{C}$ )	2,906,000			hours
Weight	—	—	113 (4.0)	g (oz.)

## Feature Specifications

Unless otherwise indicated, specifications apply over all operating input voltage, resistive load, and temperature conditions. See Feature Descriptions and Design Considerations for further information.

Parameter	Device	Symbol	Min	Typ	Max	Unit
Remote On/Off ( $V_I = 0$ V to 36 V; open collector or equivalent compatible; signal referenced to $V_I(-)$ terminal. See Figures 17 and 21 and Feature Descriptions.): DC025XXX-M (positive logic): Logic Low—Module Off Logic High—Module On DC025XXX1-M (negative logic): Logic Low—Module On Logic High—Module Off Module Specifications: On/Off Current—Logic Low On/Off Voltage: Logic Low Logic High ( $I_{on/off} = 0$ ) Open Collector Switch Specifications: Leakage Current During Logic High ( $V_{on/off} = 10$ V) Output Low Voltage During Logic Low ( $I_{on/off} = 1$ mA) Turn-on Time ( $I_o = 80\%$ of $I_{o,max}$ ; $V_o$ within $\pm 1\%$ of steady state) Output Voltage Overshoot (See Figure 17.)	All	$I_{on/off}$	—	—	1.0	mA
	All	$V_{on/off}$	0	—	1.2	V
	All	$V_{on/off}$	—	—	10	V
	All	$I_{on/off}$	—	—	50	$\mu$ A
	All	$V_{on/off}$	—	—	1.2	V
	All	—	—	5	—	ms
	All	—	—	0	5	%
Output Overvoltage Clamp	DC025ABK-M	$V_{O1}$	—	6	6.8	V
		$V_{O2}$	—	15	17	V
		$V_{O3}$	—	-15	-17	V
	DC025ACL-M	$V_{O1}$	—	6	6.8	V
		$V_{O2}$	—	19	21	V
		$V_{O3}$	—	-19	-21	V
Output Voltage Set-point Adjustment Range	All	—	90	—	110	% $V_{O,nom}$

### Characteristic Curves

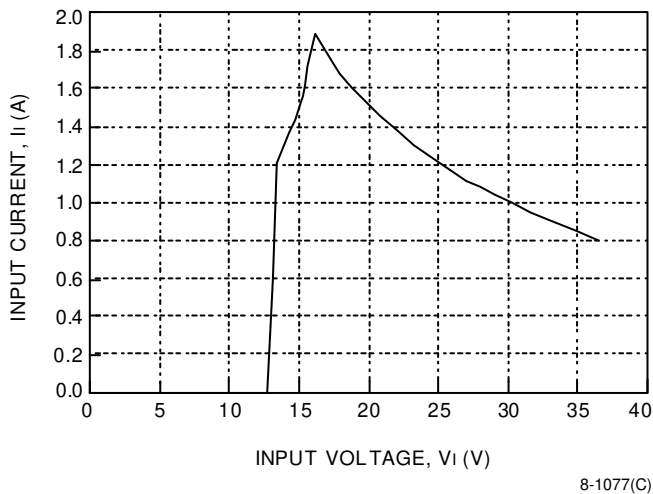

Figure 1. DC025 Triple Output-Series Typical Input Characteristics

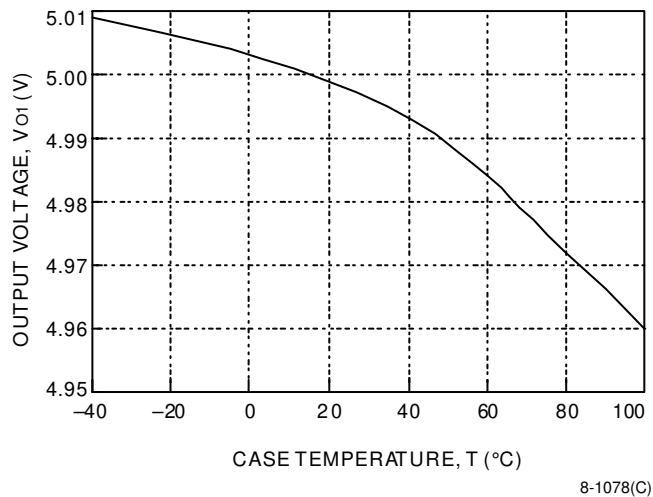

Figure 2. DC025 Triple Output-Series Typical Output Voltage Variation of 5 V Output Over Ambient Temperature Range

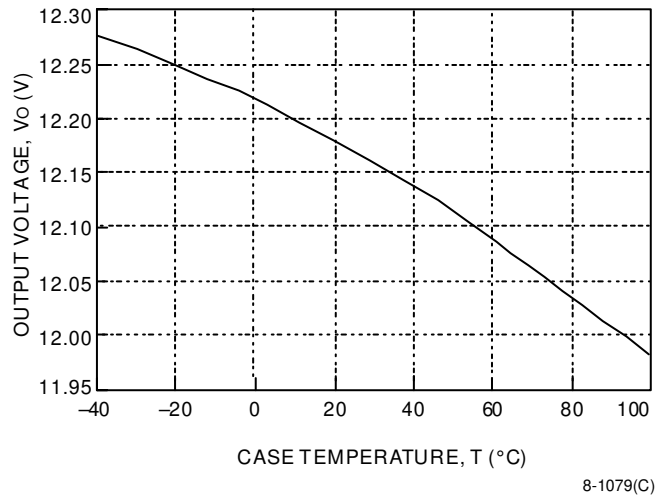

Figure 3. DC025 Triple Output-Series Typical Output Voltage Variation of 12 V Output Over Ambient Temperature Range

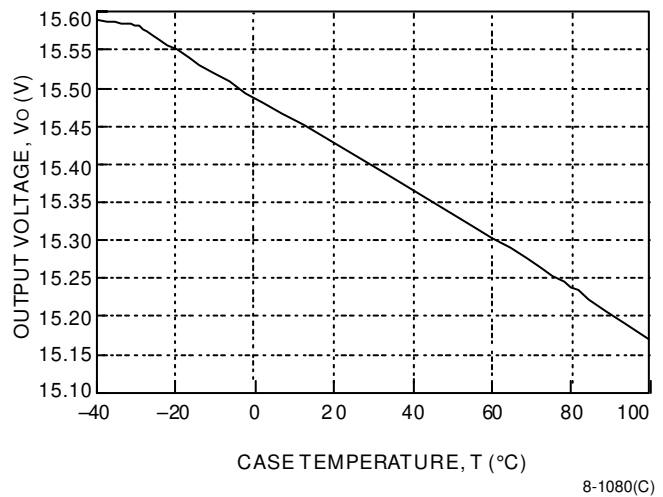
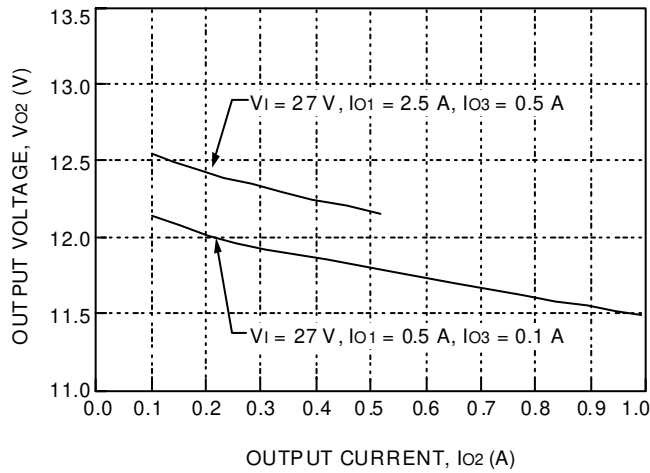

Figure 4. DC025 Triple Output-Series Typical Output Voltage Variation of 15 V Output Over Ambient Temperature Range

Characteristic Curves (continued)



8-1081(C)

Figure 5. DC025ABK-M Typical Load Regulation

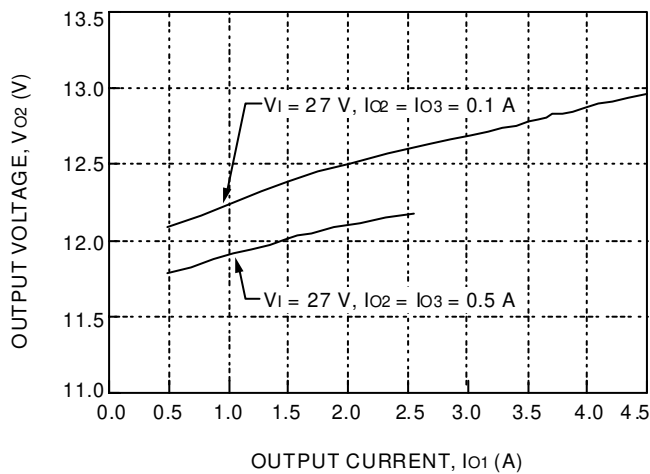

8-1082(C)

Figure 6. DC025ABK-M Typical Cross Regulation with Respect to  $I_{o1}$

**Note:** Given the same load conditions, Output 3 has regulation characteristics similar to Output 2, except the polarity is negative.

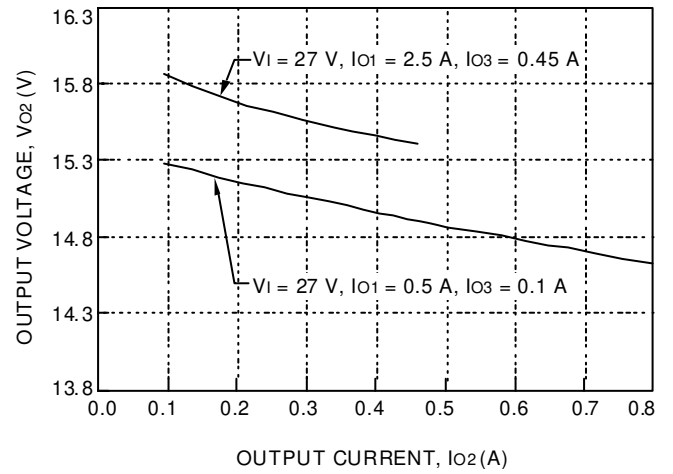

8-1083(C)

Figure 7. DC025ACL-M Typical Load Regulation

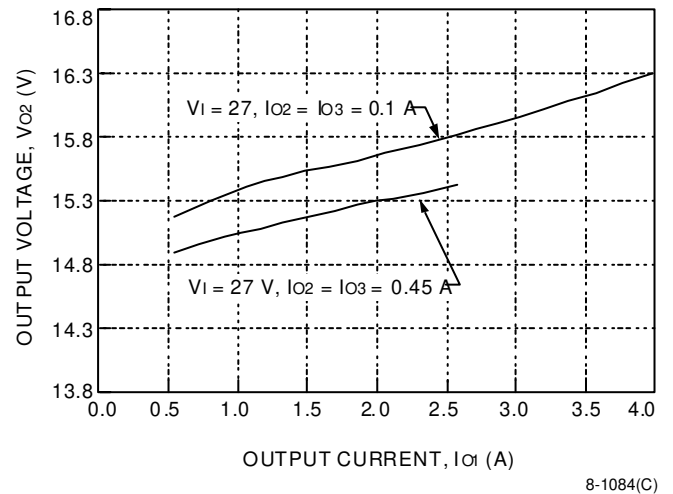

8-1084(C)

Figure 8. DC025ACL-M Typical Cross Regulation with Respect to  $I_{o1}$



Characteristic Curves (continued)

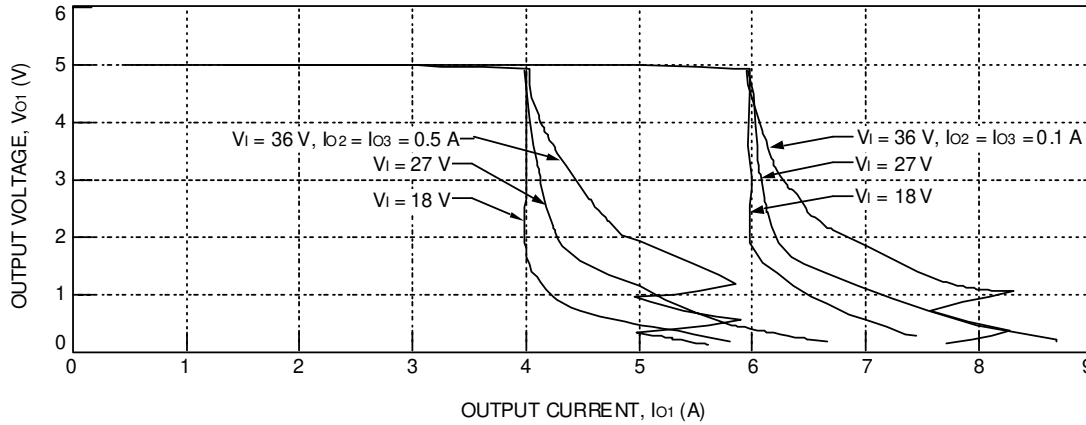

8-1085(C)

Figure 9. DC025ABK-M Typical 5 V Output Characteristics

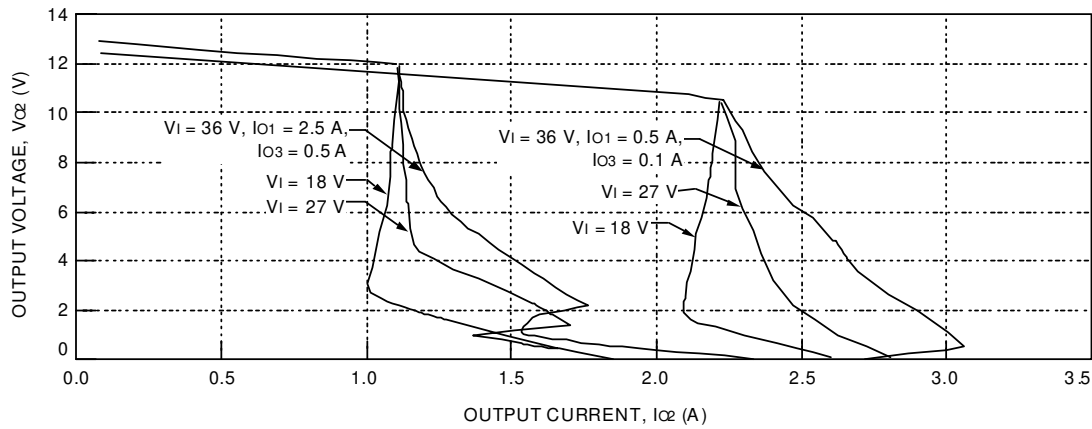

8-1086(C)

Figure 10. DC025ABK-M Typical 12 V Output Characteristics

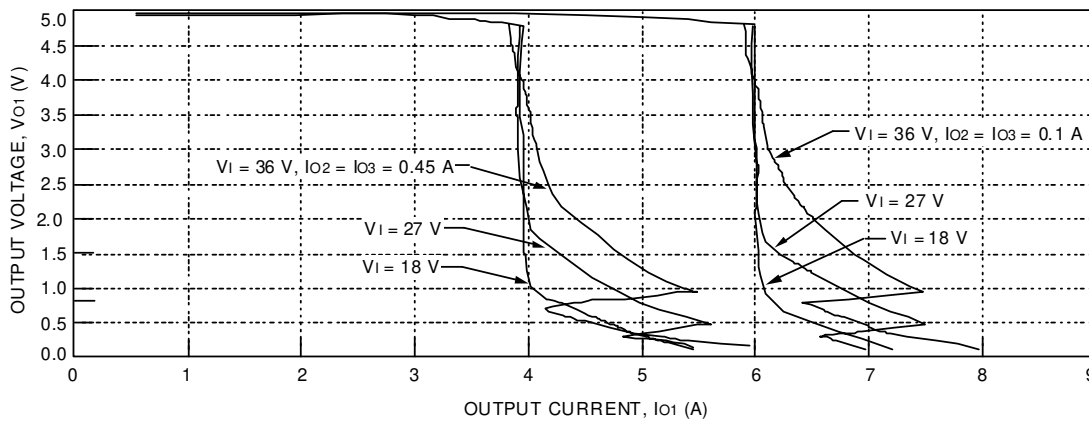

8-1087(C)

Figure 11. DC025ACL-M Typical 5 V Output Characteristics

Characteristic Curves (continued)

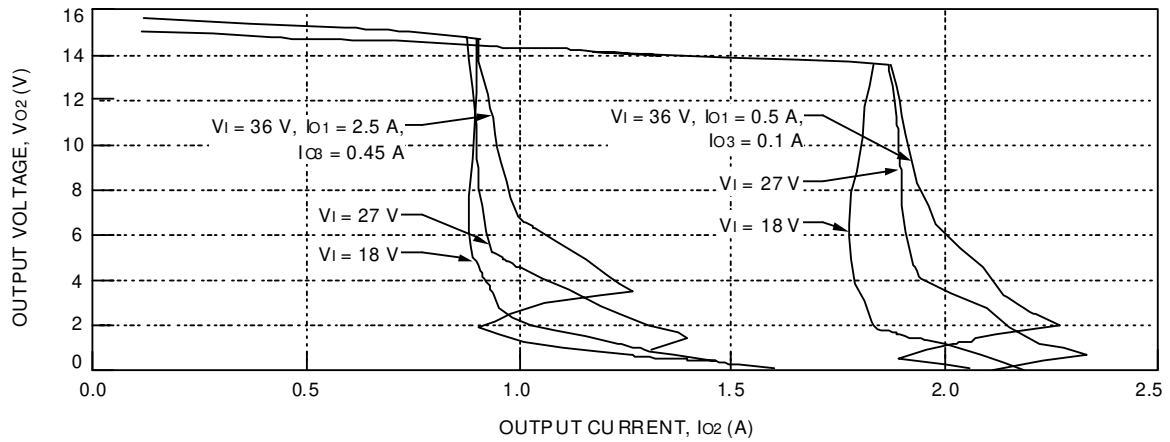

8-1088(C)

Figure 12. DC025ACL-M Typical 15 V Output Characteristics

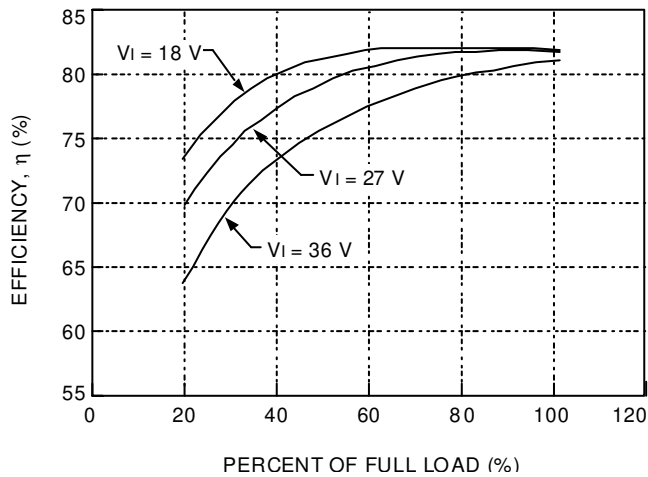

8-1089(C)

Note: Loads varied proportionately from minimum to 50% of full load.

Figure 13. DC025ABK-M Typical Converter Efficiency

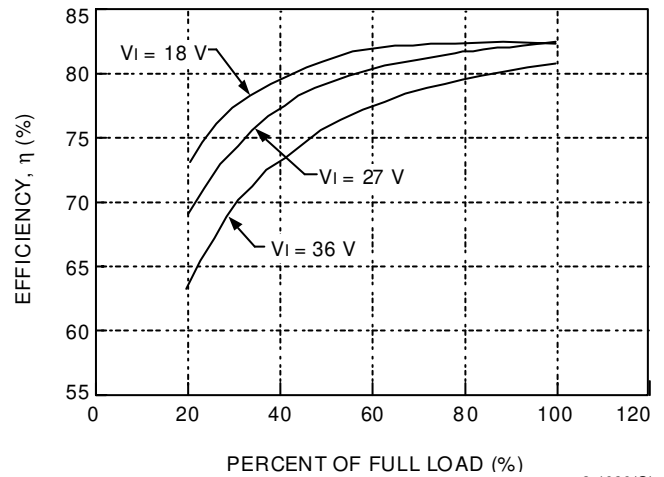

8-1090(C)

Note: Loads varied proportionately from minimum to 50% of full load.

Figure 14. DC025ACL-M Typical Converter Efficiency

Characteristic Curves (continued)

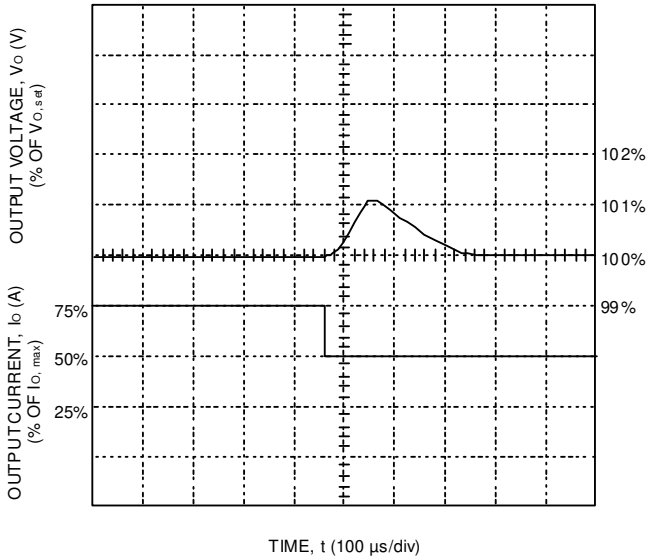

8-1098(C)

Figure 15. DC025 Triple Output-Series Typical Output Voltage for a Step Load Change from 75% to 50% of Full Load on Output 1

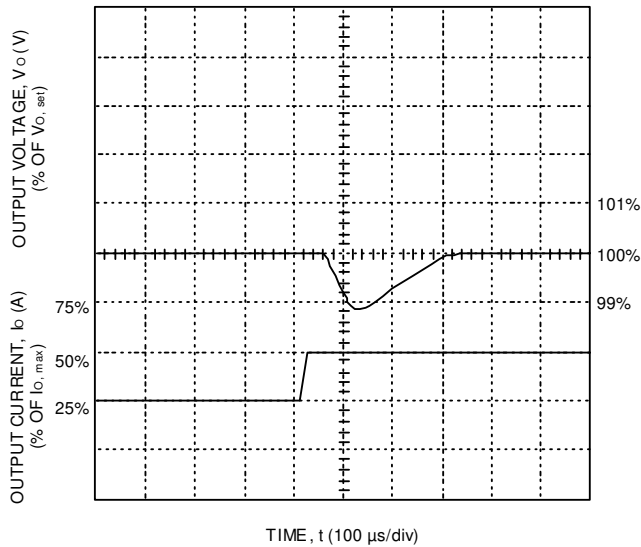

8-1099(C)

Figure 16. DC025 Triple Output-Series Typical Output Voltage for a Step Load Change from 25% to 50% of Full Load on Output 1

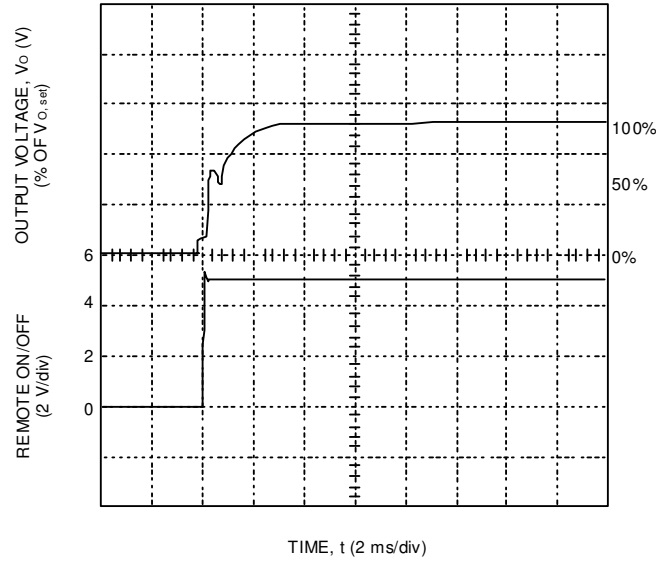

8-1100(C)

Figure 17. DC025 Triple Output-Series Typical Output Voltage Start-Up when Signal Applied to Remote On/Off

Test Configurations

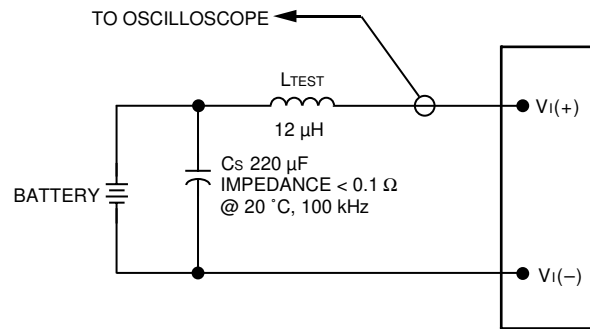

8-489(C).a

Note: Input reflected-ripple current is measured with a simulated source impedance ( $L_{TEST}$ ) of 12  $\mu$ H. Capacitor  $C_s$  offsets possible battery impedance. Current is measured at the input of the module.

Figure 18. Input Reflected-Ripple Test Setup

Test Configurations (continued)

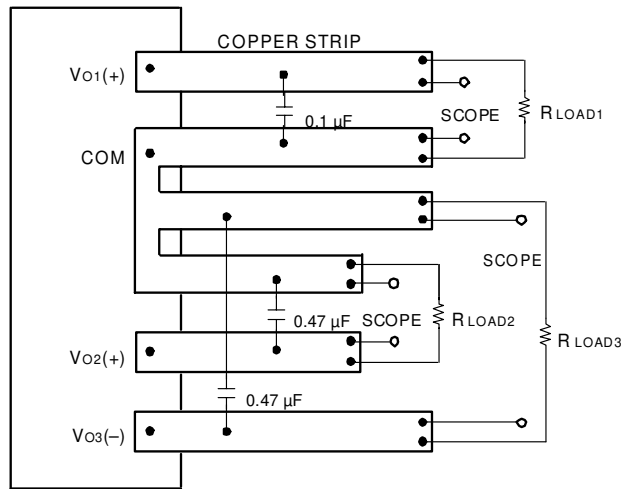

8-811(C).a

Note: Use the specified ceramic capacitor. Scope measurement should be made by using a BNC socket. Position the load between 50 mm (2 in.) and 75 mm (3 in.) from the module.

Figure 19. Output Noise Measurement Test Setup

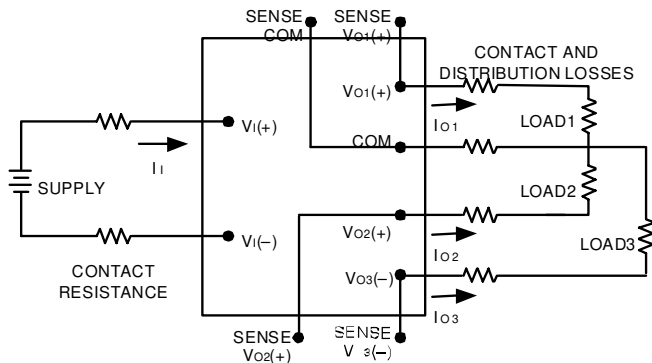

8-749(C).b

Note: All measurements are taken at the module terminals. When socketing, place Kelvin connections at module terminals to avoid measurement errors due to socket contact resistance.

$$\eta = \frac{\sum_{j=1}^3 | [V_{Oj(+)} - V_{COM}] I_{Oj} |}{[V_{I(+)} + (-V_{I(-)})] I_I} \times 100$$

Figure 20. Triple Output Voltage and Efficiency Measurement Test Setup

Design Considerations

Input Source Impedance

The power module should be connected to a low ac-impedance input source. Highly inductive source impedances can affect the stability of the power module. A 33 µF electrolytic capacitor (ESR < 0.7 ¾ at 100 kHz) mounted close to the power module helps to ensure the stability of the unit.

Safety Considerations

For safety-agency approval of the system in which the power module is used, the power module must be installed in compliance with the spacing and separation requirements of the end-use safety agency standard, i.e., UL-1950, CSA 22.2-950, and EN60950.

For the converter output to be considered meeting the requirements of safety extra-low voltage (SELV), the input must meet SELV requirements.

If the input meets extra-low voltage (ELV) requirements, then the converter's output is considered ELV.

The input to these units is to be provided with a maximum 5 A normal-blow fuse in the ungrounded lead.

## Feature Descriptions

### Output Overvoltage Clamp

The output overvoltage clamp consists of control circuitry, independent of the primary regulation loop, that monitors the voltage on the output terminals. The control loop of the clamp has a higher voltage set point than the primary loop (see Feature Specifications table). This provides a redundant voltage control that reduces the risk of output overvoltage.

### Current Limit

To provide protection in a fault (output overload) condition, the unit is equipped with internal current-limiting circuitry. At the point of current-limit inception, the unit shifts from voltage control to current control. If the output voltage is pulled very low during a severe fault, the current-limit circuit can exhibit either foldback or tailout characteristics (output current decrease or increase). The unit operates normally once the output current is brought back into its specified range.

### Output Voltage Set-Point Adjustment

The output voltage adjustment feature provides the capability of increasing or decreasing the output voltage set point of a module. This can be accomplished by using an external resistor connected between the TRIM pin and either the  $V_{O1}(+)$  or common pins. With an external resistor between the TRIM and common pins ( $R_{\text{adj-up}}$ ), the output voltage set point ( $V_{O, \text{adj}}$ ) increases.

$$R_{\text{adj-up}} = \left( \frac{42.35}{V_{O, \text{adj}} - V_{O, \text{nom}}} \right) \text{ k}\Omega$$

**Note:** The output voltage adjustment range must not exceed 110% of the nominal output voltage between the  $V_{O1}(+)$  and common terminals.

With an external resistor connected between the TRIM and  $V_{O1}(+)$  pins ( $R_{\text{adj-down}}$ ), the output voltage set point ( $V_{O, \text{adj}}$ ) decreases.

$$R_{\text{adj-down}} = \left( \frac{(V_{O, \text{adj}} - 2.5) \times 16.94}{V_{O, \text{nom}} - V_{O, \text{adj}}} \right) \text{ k}\Omega$$

**Note:** The output voltage adjustment must be 90% or more of the nominal output voltage between the  $V_{O1}(+)$  and common terminals.

### Remote On/Off

Two remote on/off options are available. Positive logic remote on/off turns the module on during a logic high voltage on the REMOTE ON/OFF pin, and off during a logic low. Negative logic remote on/off, suffix code "1," turns the module off during a logic high and on during a logic low.

To turn the power module on and off, the user must supply a switch to control the voltage between the on/off terminal and the  $V_{I(-)}$  terminal ( $V_{\text{on/off}}$ ). The switch can be an open collector or equivalent (see Figure 21). A logic low is  $V_{\text{on/off}} = 0 \text{ V}$  to  $1.2 \text{ V}$ . The maximum  $I_{\text{on/off}}$  during a logic low is  $1 \text{ mA}$ . The switch should maintain a logic low voltage while sinking  $1 \text{ mA}$ .

During a logic high, the maximum  $V_{\text{on/off}}$  generated by the power module is  $10 \text{ V}$ . The maximum allowable leakage current of the switch at  $V_{\text{on/off}} = 10 \text{ V}$  is  $50 \mu\text{A}$ .

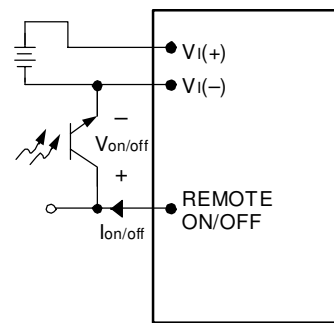

8-758(C).a

Figure 21. Remote On/Off Implementation

## Thermal Considerations

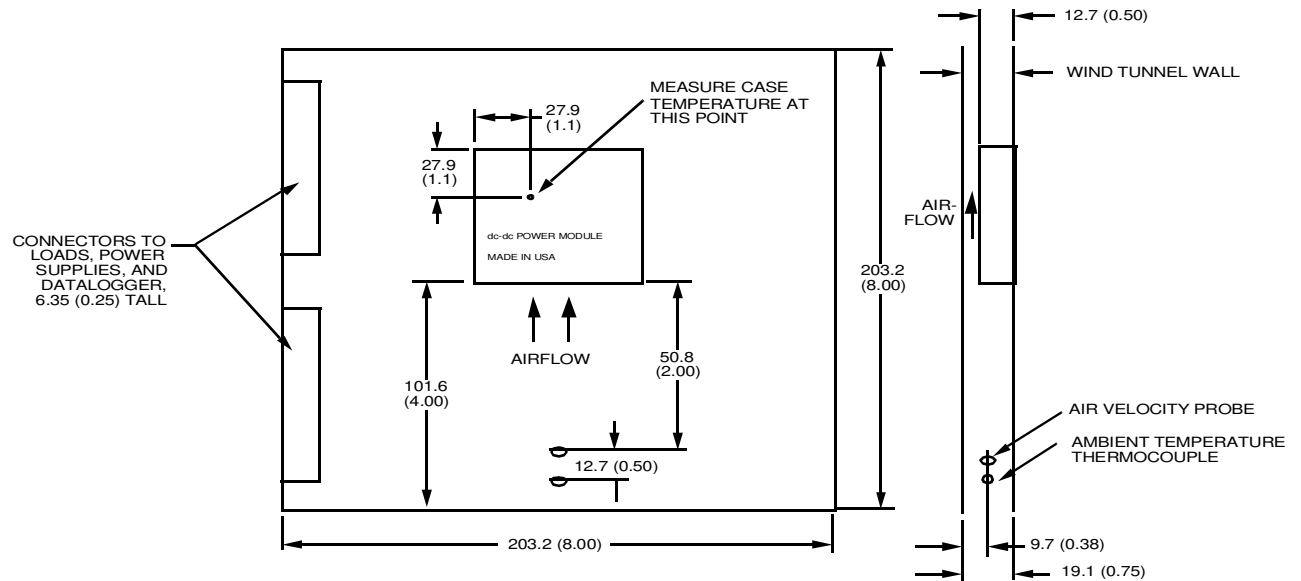

Note: Dimensions are in millimeters and (inches). Drawing is not to scale.

8-866(C).b

**Figure 22. Thermal Test Setup**

The 25 W triple output power modules are designed to operate in a variety of thermal environments. As with any electronic component, sufficient cooling must be provided to ensure reliable operation. Heat dissipating components inside the module are thermally coupled to the case to enable heat removal by conduction, convection, and radiation to the surrounding environment.

The thermal data presented is based on measurements taken in a wind tunnel. The test setup shown in Figure 22 was used to collect data. Actual performance can vary depending on the particular application environment.

## Thermal Considerations (continued)

### Basic Thermal Performance

The maximum operating temperature of the DC025 Triple Output-Series Power Modules at a given operating condition can be predicted by combining the power dissipation curves (Figures 23 through 27), the power derating curve (Figure 28), and the thermal resistance curve (Figure 28).

Use Figures 23 through 28 and the steps below to predict the safe operating region for many different operating and environmental conditions.

1. Calculate the total output power.

$$P_{\text{ototal}} = (I_{o1} \times V_{o1}) + (I_{o2} \times V_{o2}) + (I_{o3} \times V_{o3})$$

2. Use  $P_{\text{ototal}}$  with the appropriate figure (Figure 23 or 25) to determine the fixed losses ( $P_P$ ) associated with operating at  $P_{\text{ototal}}$ . These losses are independent of which output the load is being drawn from.
3. Use the desired output current ( $I_{o1}$ ) with Figure 25 to determine  $P_{S1}$ , which is the additional power being dissipated due to loading of the main output.
4. Repeat Step 3 for outputs 2 and 3 using the appropriate figure (Figure 23 or 27) to determine  $P_{S2}$  and  $P_{S3}$ , which is the power dissipated due to loading of the auxiliary outputs.
5. Find the total power dissipated ( $P_{\text{Dtotal}}$ ) by adding the four power dissipations obtained in Steps 2 through 4.

$$P_{\text{Dtotal}} = P_P + P_{S1} + P_{S2} + P_{S3}$$

6. Use the estimated total power dissipated ( $P_{\text{Dtotal}}$ ) along with Figure 28 to determine the maximum ambient temperature allowable for a given air velocity.

For example, consider the DC025ABK power module operating with 27 V input and output currents  $I_{o1} = 2.5$  A,  $I_{o2} = 0.5$  A,  $I_{o3} = 0.5$  A.

The total output power ( $P_{\text{ototal}}$ ) is 24.5 W. The total power dissipation is  $P_{\text{Dtotal}} = 4.86$  W, which is obtained by adding:

$$\begin{aligned} P_P &= 4.5 \text{ W (from Figure 23)} \\ P_{S1} &= 0.22 \text{ W (from Figure 25)} \\ P_{S2} &= 0.07 \text{ W (from Figure 23)} \\ P_{S3} &= 0.07 \text{ W (from Figure 23)} \end{aligned}$$

Figure 28 shows that in natural convection the maximum operating ambient temperature for this module is approximately 66 °C.

Keep in mind that the procedure above provides approximations of the temperature and air velocities required to keep the case temperature below its maximum rating. The maximum case temperature, as monitored at the point shown in Figure 22, should be maintained at 100 °C or less under all conditions.

### Air Velocity

The air velocity required to maintain a desired maximum case temperature for a given power dissipation and ambient temperature can be calculated using Figure 28 and the following equation:

$$\theta_{CA} = \frac{T_{C\text{max}} - T_A}{P_{\text{Dtotal}}}$$

where:

- $\theta_{CA}$  is the thermal resistance from case-to-ambient air (°C/W)
- $T_{C\text{max}}$  is the desired maximum case temperature (°C)
- $T_A$  is the ambient inlet temperature (°C)
- $P_{\text{Dtotal}}$  is the total power dissipated by the module (W) at the desired operating condition

For example, to maintain a maximum case temperature of 85 °C with an ambient inlet temperature of 65 °C and a power dissipation of 4.86 W, the thermal resistance is:

$$\theta_{CA} \geq \frac{85 \text{ °C} - 65 \text{ °C}}{4.86 \text{ W}} = 4.1 \text{ °C/W}$$

This corresponds to an airflow greater than 0.38 ms<sup>-1</sup> (75 fpm) in Figure 28.

Thermal Considerations (continued)

Air Velocity (continued)

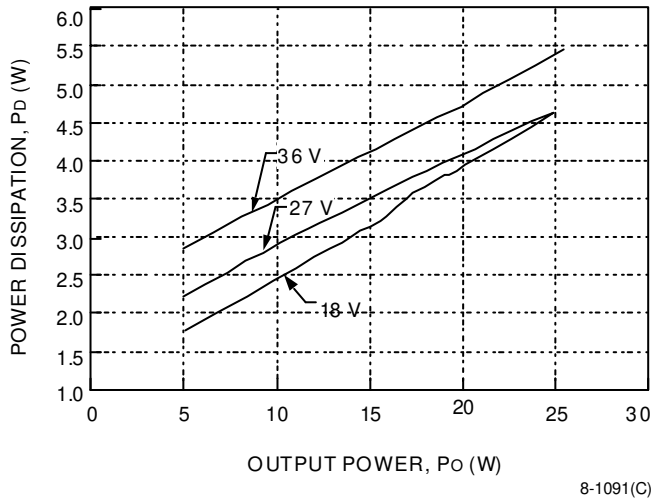

Figure 23. DC025ABK-M Fixed Losses, Pp

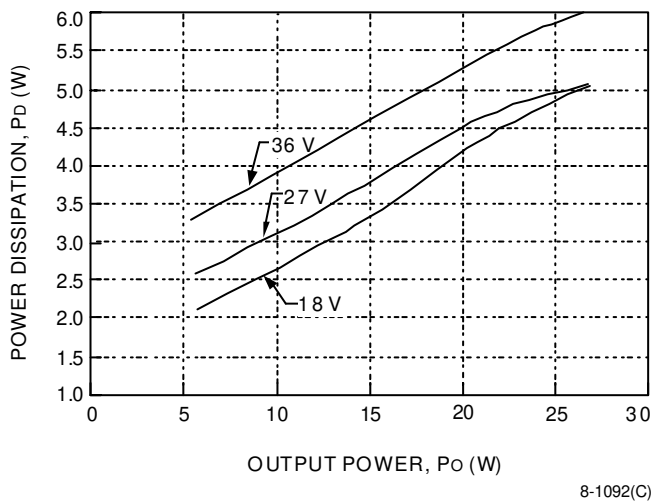

Figure 24. DC025ACL-M Fixed Losses, Pp

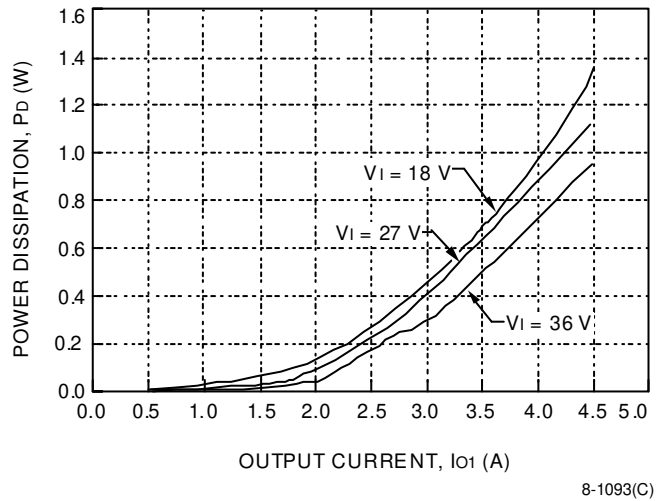

Figure 25. DC025ABK-M, DC025ACL-M Losses, Associated with 5 V Output, Ps1

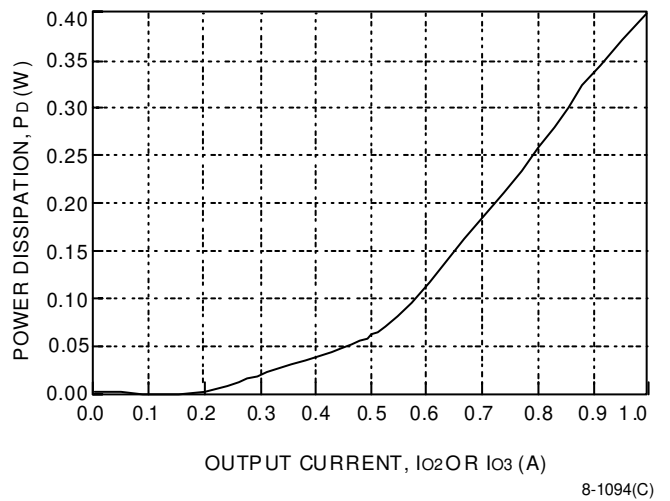
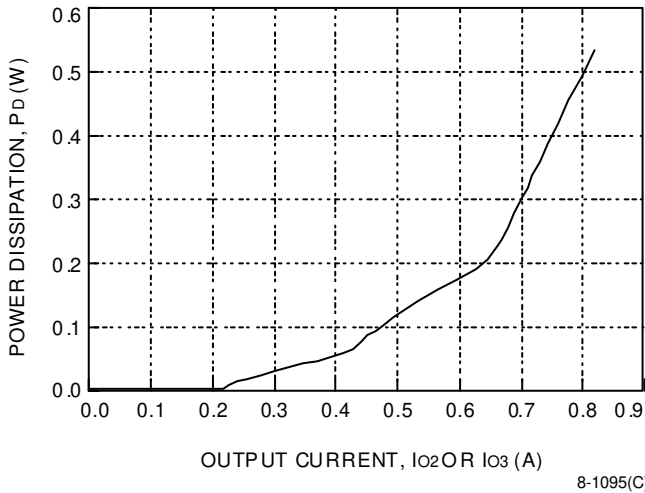

Figure 26. DC025ABK-M, Losses Associated with ±12 V Output, Ps2/Ps3



**Thermal Considerations** (continued)

**Air Velocity** (continued)



**Figure 27. DC025ACL-M Losses Associated with ±15 V Output, Ps2/Ps3**

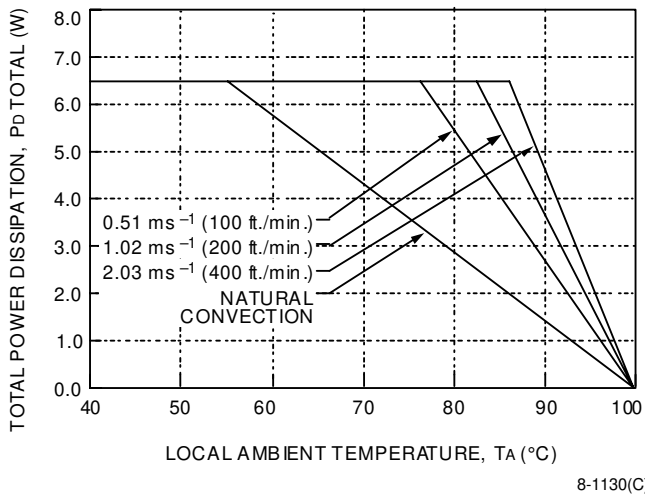

**Figure 28. Total Power Dissipation vs. Local Ambient Temperature and Air Velocity**

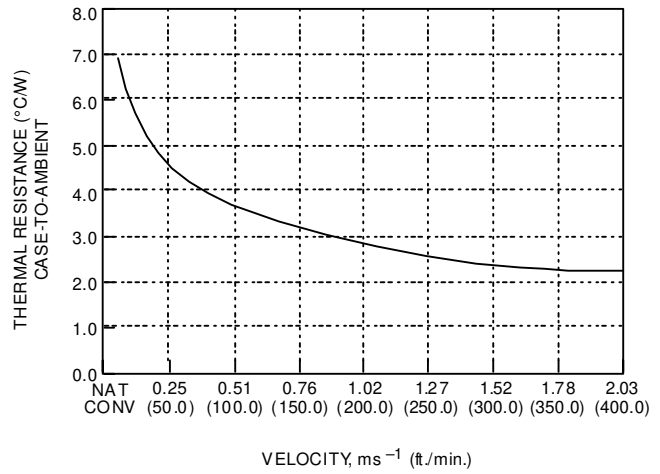
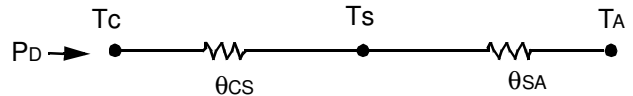

**Figure 29. Case-to-Ambient Thermal Resistance vs. Air Velocity**

**Use of Heat Sinks and Cold Plates**

The DC025 Triple Output-Series case includes through-threaded M3 x 0.5 mounting holes allowing attachment of heat sinks or cold plates from either side of the module. The mounting torque must not exceed 0.56 N/m (5 in.-lb).

The following thermal model can be used to determine the required thermal resistance of the sink to provide the necessary cooling:



where  $P_D$  is the power dissipated by the module,  $\theta_{cs}$  represents the interfacial contact resistance between the module and the sink, and  $\theta_{SA}$  is the sink-to-ambient thermal impedance ( $^{\circ}\text{C}/\text{W}$ ). For thermal greases or foils, a value of  $\theta_{cs} = 0.1\text{ }^{\circ}\text{C}/\text{W}$  to  $0.3\text{ }^{\circ}\text{C}/\text{W}$  is typical.

The required  $\theta_{SA}$  is calculated from the following equation:

$$\theta_{SA} = \frac{T_C - T_A}{P_{D\text{total}}} - \theta_{cs}$$

Note that this equation assumes that all dissipated power must be shed by the sink. Depending on the user-defined application environment, a more accurate model including heat transfer from the sides and rear of the module can be used. This equation provides a conservative estimate in such instances.

For further thermal information on these modules, refer to the *Thermal Management for CC-, CW, DC, DW-Series 25 W to 30 W Board-Mounted Power Modules* Technical Note.

## Outline Diagram

Dimensions are in millimeters and (inches).

Copper paths must not be routed beneath the power module standoffs.

Tolerances:  $x.x \pm 0.5$  mm (0.02 in.),  $x.xx \pm 0.25$  mm (0.010 in.).

### Top View

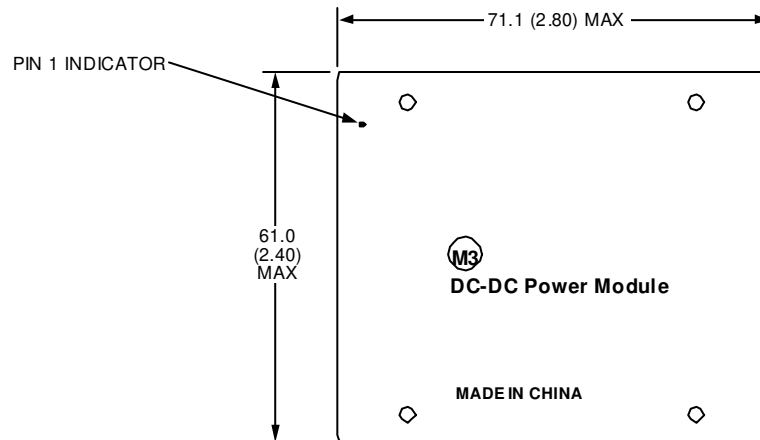

### Side View

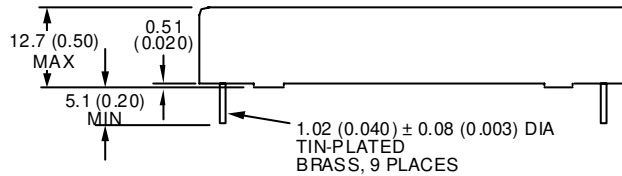

### Bottom View

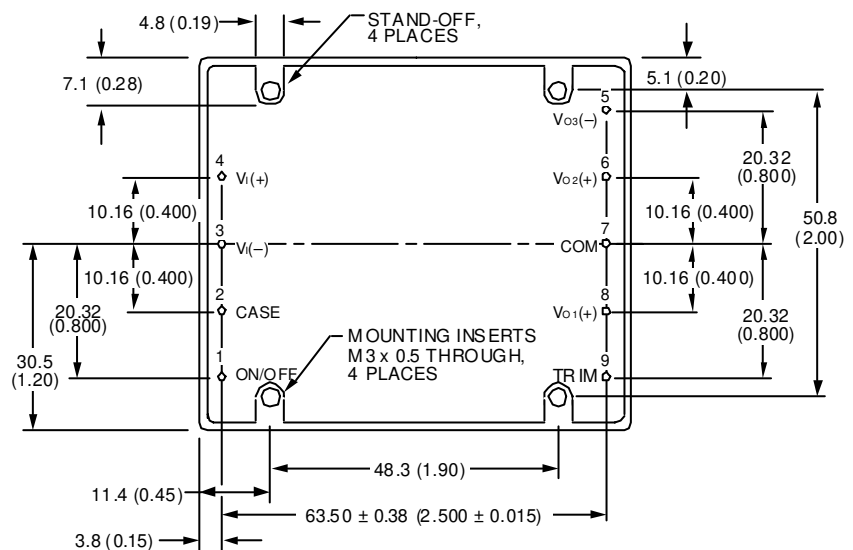

8-846(C)

## Recommended Hole Pattern

Component-side footprint.

Dimensions are in millimeters and (inches).

Recommended hole size for pin: 1.27 mm (0.050 in.)

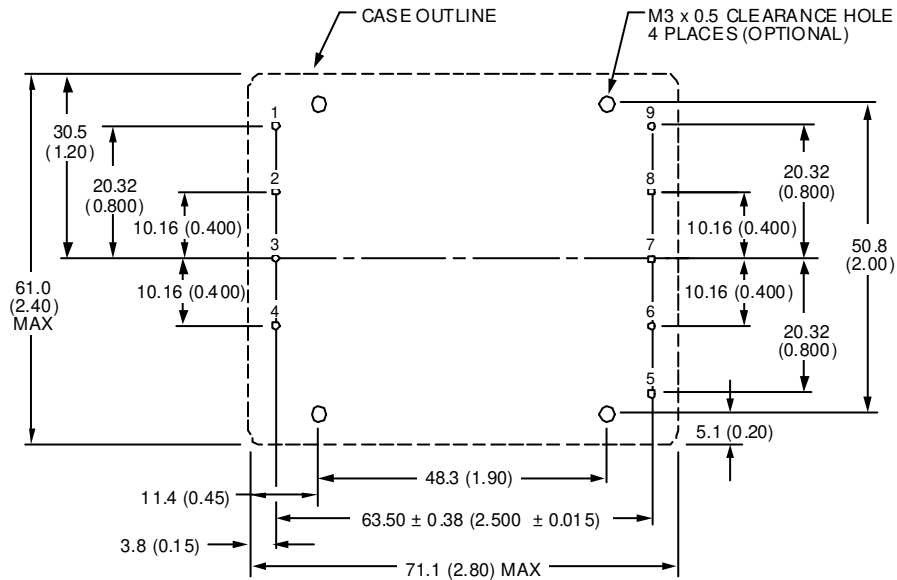

8-846(C)

## Ordering Information

Table 4. Ordering Information Table

Input Voltage	Output Voltage	Output Power	Remote On/Off Logic	Device Code	Comcode
18 V—36 V	+5 V, $\pm 12$ V	25 W	positive	DC025ABK-M	107587313
18 V—36 V	+5 V, $\pm 15$ V	25 W	positive	DC025ACL-M	107587339

Optional features may be ordered using the device code suffixes shown below. To order more than one option, list suffixes in numerically descending order followed by the -M suffix, indicating metric (M3 x 0.5 heat sink hardware). The heat sinks designed for this package have an M prefix, i.e., MHSTxxx45 and MHSLxxx45 (see *Thermal Energy Management CC-, CW-, DC-, and DW-Series 25 W to 30 W Board-Mounted Power Modules Technical Note*).

Table 5. Options Table

Option	Device Code Suffix
Short pins: 2.79 mm $\pm$ 0.25 mm (0.110 in. $\pm$ 0.010 in.)	8
Negative on/off logic	1

Please contact your Lineage Power Account Manager or Field Application Engineer for pricing and availability of options.



**LINEAGE POWER**

### World Wide Headquarters

#### Lineage Power Corporation

3000 Skyline Drive, Mesquite, TX 75149, USA

+1-800-526-7819

(Outside U.S.A.: +1-972-284-2626)

[www.lineagepower.com](http://www.lineagepower.com)

e-mail: [techsupport1@lineagepower.com](mailto:techsupport1@lineagepower.com)

### Asia-Pacific Headquarters

Tel: +65 6416 4283

### Europe, Middle-East and Africa Headquarters

Tel: +49 898 780 672 80

### India Headquarters

Tel: +91 80 2841 1633

Lineage Power reserves the right to make changes to the product(s) or information contained herein without notice. No liability is assumed as a result of their use or application. No rights under any patent accompany the sale of any such product(s) or information.

© 2008 Lineage Power Corporation, (Mesquite, Texas) All International Rights Reserved.

April 2009

DS96-128EPS (Replaces DS94-054EPS)