



Chipsmall Limited consists of a professional team with an average of over 10 year of expertise in the distribution of electronic components. Based in Hongkong, we have already established firm and mutual-benefit business relationships with customers from,Europe,America and south Asia,supplying obsolete and hard-to-find components to meet their specific needs.

With the principle of “Quality Parts,Customers Priority,Honest Operation,and Considerate Service”,our business mainly focus on the distribution of electronic components. Line cards we deal with include Microchip,ALPS,ROHM,Xilinx,Pulse,ON,Everlight and Freescale. Main products comprise IC,Modules,Potentiometer,IC Socket,Relay,Connector.Our parts cover such applications as commercial,industrial, and automotives areas.

We are looking forward to setting up business relationship with you and hope to provide you with the best service and solution. Let us make a better world for our industry!



Contact us

Tel: +86-755-8981 8866 Fax: +86-755-8427 6832

Email & Skype: info@chipsmall.com Web: www.chipsmall.com

Address: A1208, Overseas Decoration Building, #122 Zhenhua RD., Futian, Shenzhen, China



LTC2757

18-Bit, Parallel Input, SoftSpan I_{OUT} DAC

DESCRIPTION

Demonstration circuit 1485A features the LTC[®]2757A single 18-bit SoftSpan™ I_{OUT} DAC with ±1LSB maximum INL. This device features six programmable output ranges: 0V to 5V, 0V to 10V, ±5V, ±10V, ±2.5V and -2.5V to 7.5V. The demo circuit allows all of the LTC2757's features to be exercised, including system-level gain and offset adjustments.

Design files for this circuit board are available at <http://www.linear.com/demo>

LT, LT, LTC, LTM, Linear Technology and the Linear logo are registered trademarks and SoftSpan and QuikEval are trademarks of Linear Technology Corporation. All other trademarks are the property of their respective owners.

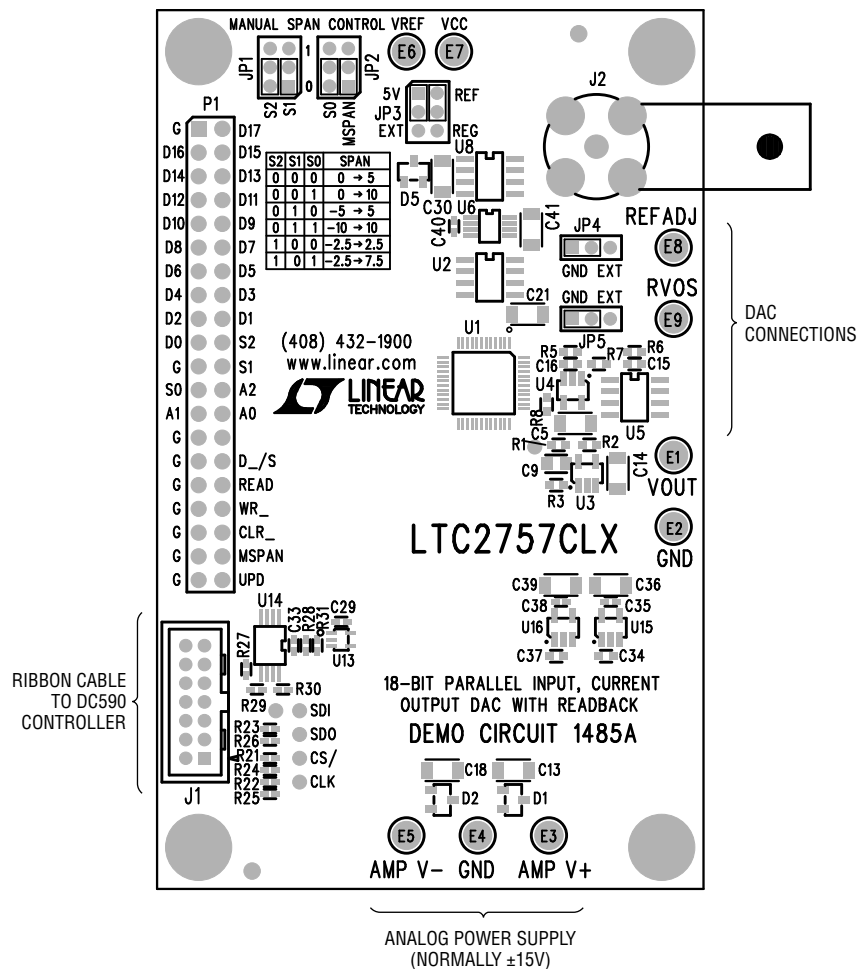

Figure 1. Connection Diagram

QUICK START PROCEDURE

Connect a clean $\pm 15V$ power supply to the turret posts at the bottom of the DC1485A board. Connect J1 to a DC590 USB serial controller using the supplied 14-conductor ribbon cable. Connect DC590 to a host PC with a standard USB A/B cable. Run the QuikEval™ evaluation software which can be downloaded from www.linear.com/software. The correct control panel will be loaded automatically. The software automatically sets the LTC2757 outputs according

to the entries in the control panel. A square wave option is available to test settling time. MSPAN jumper should be in the lower position if software span control is desired.

Additional software documentation may be available from the Help menu item, as features may be added periodically.

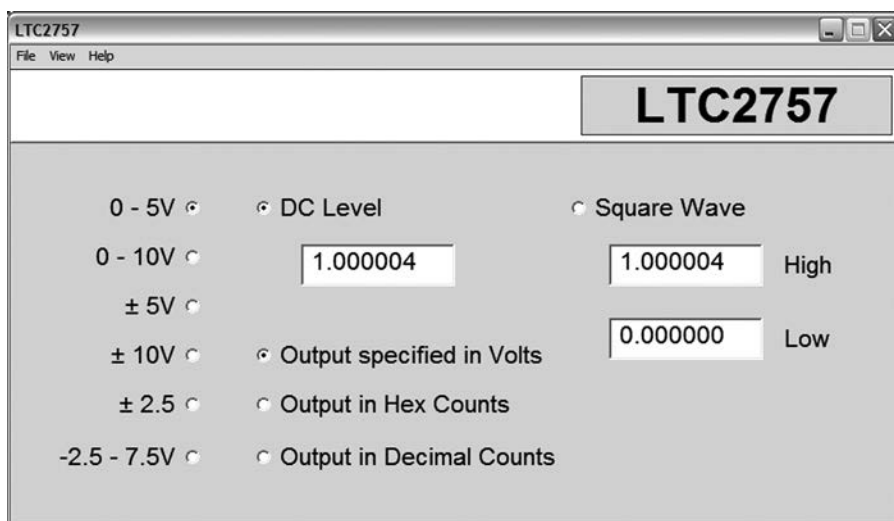

USING THE PARALLEL CONNECTOR

Protocol

The DC1485A can be used without the DC590 QuikEval system. If a DC590 demo board is not connected the shift registers on the DC1485A are disabled, allowing the user to clock in data through the parallel connector (P1).

The data input register is loaded directly from the 18-bit microprocessor bus (D0-D17 on the parallel connector) by holding the D_/S pin low and then pulsing the WR_ pin low. The second register (DAC register) is loaded by pulsing the UPD pin high, which copies the data held in the input register into the DAC register. Note that updates always include both data and span; but the DAC register values will not change unless the input register values have been changed by writing.

Loading the span input register is accomplished in a similar manner, by holding the D_/S pin high and then bringing the WR_ pin low. The span and data register structures are the same except for the number of parallel bits. The span registers have three bits, while the data registers have 18 bits.

Please see the LTC2757 data sheet for in depth timing diagrams and more information about the communication protocol.

Parallel Pin Descriptions

D0-D17: DAC Input/Output Data Bits. These I/O pins set and read back the DAC code. D17 is the MSB. D0 is the LSB.

S0-S2: Span Input/Output. Pins S0, S1 and S2 are used to program and to read back the output range of the DAC.

D_/S: Data/Span Select: This pin is used to select activation of the data or span I/O pins (D0 to D17 or S0 to S2, respectively), along with their respective dedicated registers, for write or read operations. Update operations ignore D_/S, since all updates affect both data and span registers. For single-span operation, tie D_/S to GND.

READ: Read Pin. When READ is asserted high, the data I/O pins (D0-D17) or span I/O pins (S0-S2) output the contents of the selected register. For single-span operation, readback of the span I/O pins is disabled.

UPD: Update and Buffer Select Pin. When READ is held low and UPD is asserted high, the contents of the input registers (both data and span) are copied into their respective DAC registers. The output of the DAC is updated, reflecting the new DAC register values. When READ is held high, the update function is disabled and the UPD pin functions as a buffer selector—logic low to select the input register, high for the DAC register.

WR_: Active Low Write Pin. A Write operation copies the data present on the data or span I/O pins (D0-D17 or S0-S2, respectively) into the input register. When READ is high, the Write function is disabled.

MSPAN: Manual Span Control Pin. MSPAN is used to configure the LTC2757 for operation in a single, fixed output range.

G: Ground Pin. (Note, if an IDE cable is used, Pin 21 is often keyed on the connector and may be trimmed.)

HARDWARE SETUP

Jumpers

MSPAN: Manual Span Control Pin. MSPAN is used to configure the LTC2757 for operation in a single, fixed output range. If MSPAN is high it will be configured for single-span use. If MSPAN is low it will be set through the QuikEval Software. Default position is 0 (low).

S0, S1, S2: Used to set the fixed output range if MSPAN is high. Default position is 0, 0, 0 (0V to 5V).

S2	S1	S0	SPAN
0	0	0	0V to 5V
0	0	1	0V to 10V
0	1	0	±5V
0	1	1	±10V
1	0	0	±2.5 V
1	0	1	-2.5V to 7.5V

REFADJ: Gain Adjust Pin. If no adjustments are required, select GND. Selecting EXT connects the pin to the turret allowing external adjustment to null gain error or compensate for reference errors.

RVOS: Offset adjustment for DAC. If no offset adjustment is required, select GND. Selecting EXT connects the offset pin to the turret allowing external adjustment of offset.

V_{CC}: Select source for 5V V_{CC} supply. Set to 5V for supply by onboard LT1236 reference (recommended). Set to REG to be supplied by regulated supply from DC590 Controller and remove the jumper to supply externally.

Analog Connections (Turret Posts)

V_{OUT}: DAC Voltage Output.

V_{REF}: DAC Reference Voltage. If the onboard LT1236 references are selected, the voltage may be measured at these points. If a remote reference is selected, then an external reference must be applied to these points.

RVOS: DAC Offset Adjust Input. Use only if RVOS jumper is set to EXT. Nominal input range is ±5V.

REFADJ: Gain Adjust Pin. This voltage-control pin can be used to null gain error or to compensate for reference errors. The gain error change expressed in LSB is the same for any output range.

Power and Ground Connections

Analog Power: The 15V, -15V and GND turret posts are the analog supplies for the internal DAC amplifiers. These should be connected to a well regulated, low noise power supply.

V_{CC}: Connection to V_{CC}. See schematic and description for V_{CC} jumper.

Grounding: Separate power and signal grounds are provided. Signal GND is the turret closest to V_{OUT}, use this for measurement ground and output return. Power GND is between AMP V⁺ and AMP V⁻ turrets.

PARTS LIST

ITEM	QTY	REFERENCE	PART DESCRIPTION	MANUFACTURE/PART NUMBER	KIT QTY
				NUMBER OF BOARDS =	175
1	16	C1-C4, C6-C8, C10-C12, C19, C25, C29, C31, C33, C40	CAP, X5R, 0.1µF 25V 20%, 0402	TDK, C1005X5R1E104M	2800
2	2	C5, C20	CAP, NPO, 100pF 50V, 5%,1206	AVX, 12065A101JAT2A	350
3	1	C9	CAP, X7R, 1µF 25V 10%, 0805	TDK, C2012X7R1E105K	175
4	2	C34, C37	CAP, X5R, 1µF 25V 20%, 0603	TDK, C1608X5R1E105M	350
5	6	C13, C18, C30, C36, C39, C41	CAP, X5R, 10µF 25V 20%,1206	TDK, C3216X5R1E106M	1050
6	1	C14	CAP, X7R, 1µF 25V 10%,1206	AVX, 12063C105KAT2A	175
7	0	C15, C16	CAP, 0603	OPT	0
8	0	C21	CAP, 1206	OPT	0
9	3	C17, C23, C28	CAP, NPO, 100pF 50V, 5%,0402	AVX, 04025A101JAT2A	525
10	2	C38, C35	CAP, X7R, 0.01µF 25V 20%,0402	TDK, C1005X7R1E103M	350
11	3	D1, D2, D5	DIODE, SCHOTTKY, SOT23	DIODES INC., BAT54C-7-F	525
12	9	E1, E2, E3, E4, E5, E6, E7, E8, E9	TEST POINT, TURRET, 0.064"	MILL-MAX, 2308-2-00-80-00-00-07-0	1575
13	3	JP1, JP2, JP3	JMP, 2X3, 0.079"	SAMTEC, TMM-103-02-L-D	525
14	2	JP4, JP5	JMP, 1X3, 0.079"	SAMTEC, TMM-103-02-L-S	350
15	1	J1	HEADER, 2X7 PIN, 0.079CC	MOLEX, 87831-1420	175
16	0	J2	CONN, BNC, RTANG 50Ω	OPT (TYCO ELEC. AMP, 413631-1)	0
17	1	P1	JMP, 2X20, 0.100"	SAMTEC, TSW-120-07-L-D	175
18	2	R1, R2	RES., Chip 10k 1/16W 5%, 0603	VISHAY, CRCW060310K0JNEA	350
19	3	R7, R8, R3	RES., Chip 1k 1/16W 5%, 0603	VISHAY, CRCW06031K00JNEA	525
20	6	R4, R9, R20, R21, R22, R23	RES., Chip 100Ω 1/16W 5%, 0402	VISHAY, CRCW0402100RJNED	1050
21	1	R5	RES., Chip 10Ω 1/16W 5%, 0603	VISHAY, CRCW060310R0JNEA	175
22	1	R6	RES., Chip 4.02k 1/16W 1%, 0603	VISHAY, CRCW06024K02FKED	175
23	8	R11, R16, R17, R18, R19, R27, R29, R30	RES., Chip 4.99k 1/16W 1%, 0402	VISHAY, CRCW04024K99FKED	1400
24	4	R24, R25 ,R26, R31	RES., Chip 10k 1/16W 5%,0402	VISHAY, CRCW040210K0JNED	700
25	1	R28	RES., Chip 20k 1/16W 5%,0402	VISHAY, CRCW040220K0JNED	175
26	1	U1	I.C., LTC2757ACLX, LQFP48LX	LINEAR TECH., LTC2757ACLX	175
27	1	U2	I.C., LT1012ACS8, S08	LINEAR TECH., LT1012ACS8	175
28	1	U3	I.C., LTC2054HVCS5, SOT23-5	LINEAR TECH., LTC2054HVCS5	175
29	1	U4	I.C., LTC6240HVCS5, SOT23-5	LINEAR TECH., LTC6240HVCS5	175
30	1	U5	I.C., LT1360CS8, S08	LINEAR TECH., LT1360CS8	175
31	0	U6	I.C., LTC6655AHMS8-5, MSOP8	OPT	0
32	1	U8	I.C., LT1236ACS8-5, S08	LINEAR TECH., LT1236ACS8-5	175
32	4	U9, U10, U11, U12	I.C., 74VHC595MTC, TSSOP16	FAIRCHILD SEMI., 74VHC595MTCX	700
33	1	U13	I.C., NC7SZ14P5X, SC70-5	FAIRCHILD SEMI., NC7SZ14P5X	175
34	1	U14	I.C., Serial EEPROM, TSSOP8	MICROCHIP, 24LC025-I/ST	175
35	1	U15	I.C., LT1761ES5-5, SOT23-5	LINEAR TECH., LT1761ES5-5	175
36	1	U16	I.C., LT1964ES5-5, SOT23-5	LINEAR TECH., LT1964ES5-5	175
37	8	SHUNTS AS SHOWN ON ASSY DWG	SHUNT, 0.079" CENTER	SAMTEC, 2SN-BK-G	1400
38	4	MTG	STAND-OFF, NYLON (SNAP ON), 0.50" TALL	KEYSTONE, 8833 (SNAP ON)	700
39	2		STENCILS BOTH SIDES	DC1485A-1	2

NOTES: UNLESS OTHERWISE SPECIFIED

1. ALL RESISTORS ARE IN OHMS, 0402.
2. INSTALL SHUNTS ON JUMPERS AS SHOWN.

REVISION HISTORY				
ECO	REV	DESCRIPTION	APPROVED	DATE
-	2	PRODUCTION	LEO C.	02-13-14

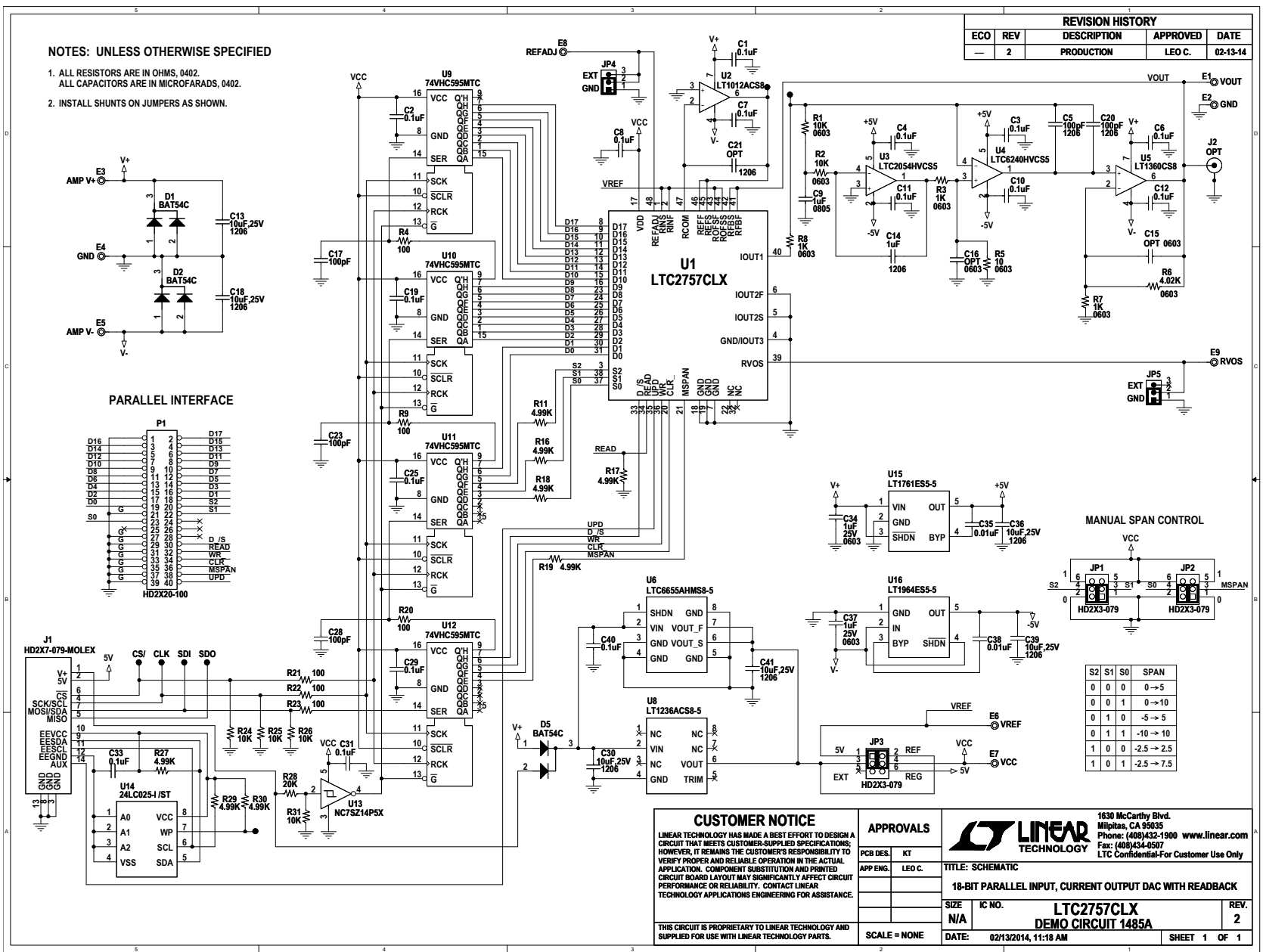

S2	S1	S0	SPAN
0	0	0	0 → 5
0	0	1	0 → 10
0	1	0	-5 → 5
0	1	1	-10 → 2.5
1	0	0	-2.5 → 2.5
1	0	1	-2.5 → 7.5

CUSTOMER NOTICE
 LINEAR TECHNOLOGY HAS MADE A BEST EFFORT TO DESIGN A CIRCUIT THAT MEETS CUSTOMER-SUPPLIED SPECIFICATIONS; HOWEVER, IT REMAINS THE CUSTOMER'S RESPONSIBILITY TO VERIFY PROPER AND RELIABLE OPERATION IN THE ACTUAL APPLICATION. COMPONENT SUBSTITUTION AND PRINTED CIRCUIT BOARD LAYOUT MAY SIGNIFICANTLY AFFECT CIRCUIT PERFORMANCE OR RELIABILITY. CONTACT LINEAR TECHNOLOGY APPLICATIONS ENGINEERING FOR ASSISTANCE.

APPROVALS	
PCB DES. KT	
APP ENG. LEO C.	
SCALE = NONE	

LINEAR TECHNOLOGY
 1630 McCarthy Blvd.
 Milpitas, CA 95035
 Phone: (408)432-1900 www.linear.com
 Fax: (408)434-0507
 LTC Confidential-For Customer Use Only

TITLE: SCHEMATIC
 18-BIT PARALLEL INPUT, CURRENT OUTPUT DAC WITH READBACK

SIZE N/A	IC NO. LTC2757CLX	REV. 2
DATE: 02/13/2014, 11:18 AM		SHEET 1 OF 1

ASSEMBLY DRAWINGS

REVISIONS			
REV	DESCRIPTION	APPR	DATE
2	3RD PROTOTYPE	LEO C.	08-05-09

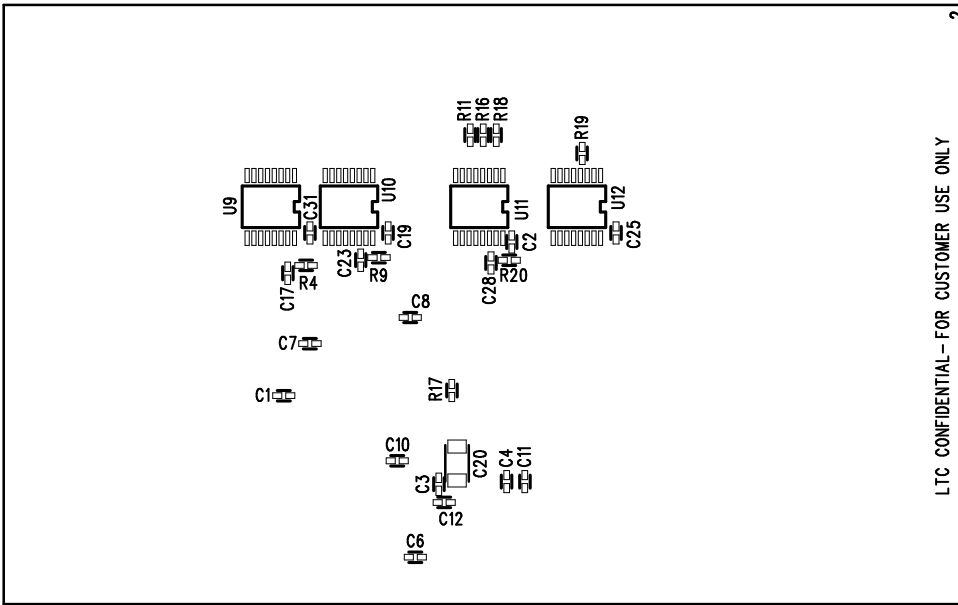

APPROVALS		INIT		DATE
DRAWN				
CHECK				
DESIGN	KIM T.			08-05-09
ENGR	LEO C.			08-05-09
SCALE = NONE				

 LINEAR TECHNOLOGY		1630 MCCARTHY BLVD MILPITAS, CA 95035 PH: (408)432-1900 LTC CONFIDENTIAL - FOR CUSTOMER USE ONLY	
TITLE: BOTTOM ASSEMBLY DRAWING			
18-BIT PARALLEL INPUT, CURRENT OUTPUT DAC WITH READBACK			
SIZE	A	DC1485A-2 * LTC2757CLX	REV. 2
			SHT 2 of 2

PCB LAYOUT AND FILM

Top Silkscreen

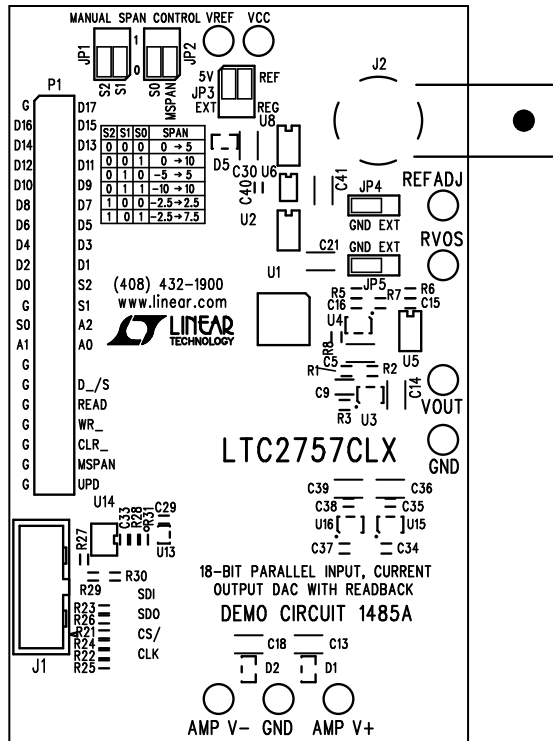

Top Solder Paste

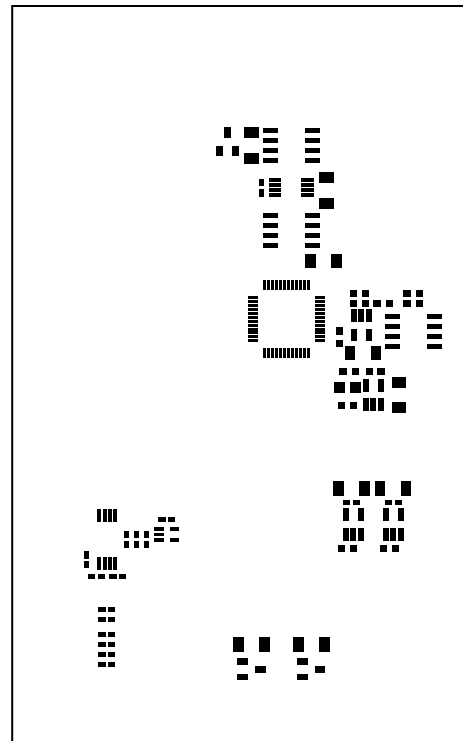

Top Solder Mask

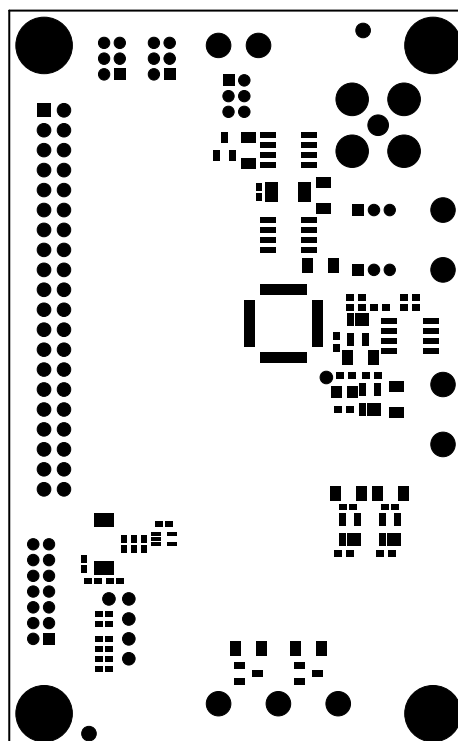

PCB LAYOUT AND FILM

Layer 1-Top Layer

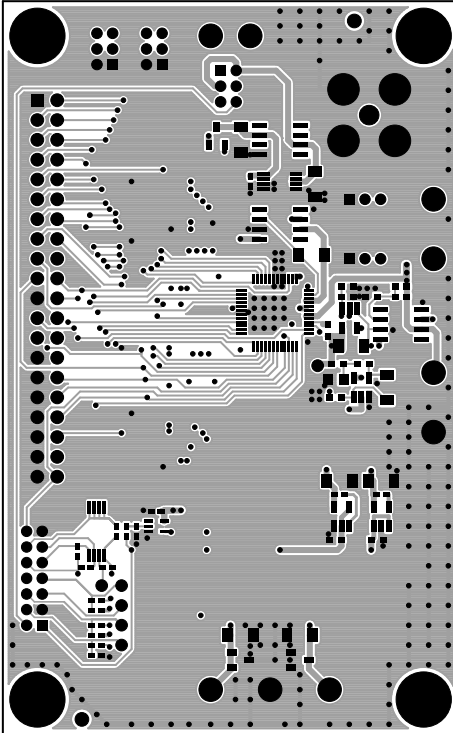

Layer 2-GND Plane 1

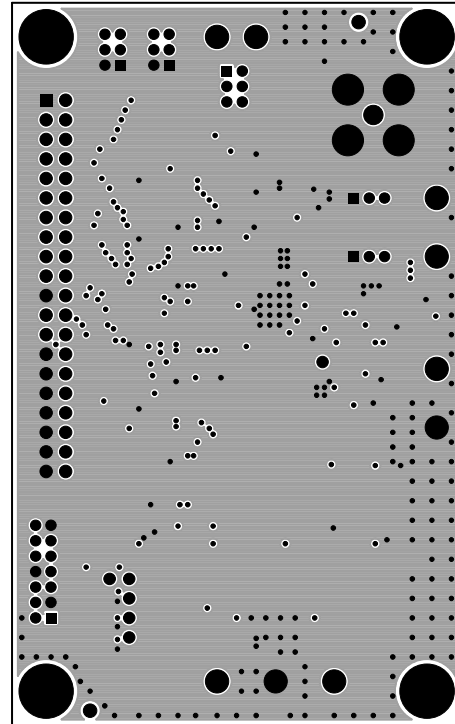

Layer 3- GND Plane 2 + PWR Traces

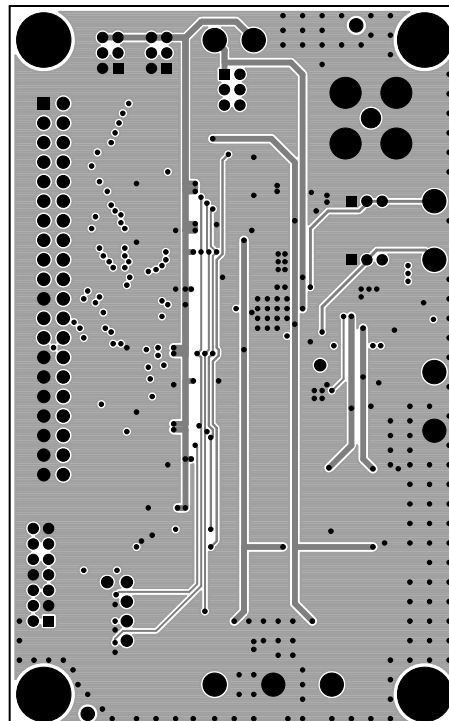

PCB LAYOUT AND FILM

Layer 4-Bottom Layer

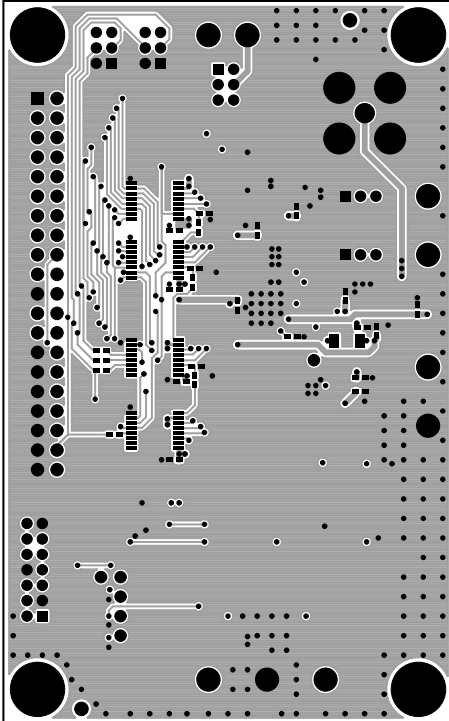

Bottom Solder Mask

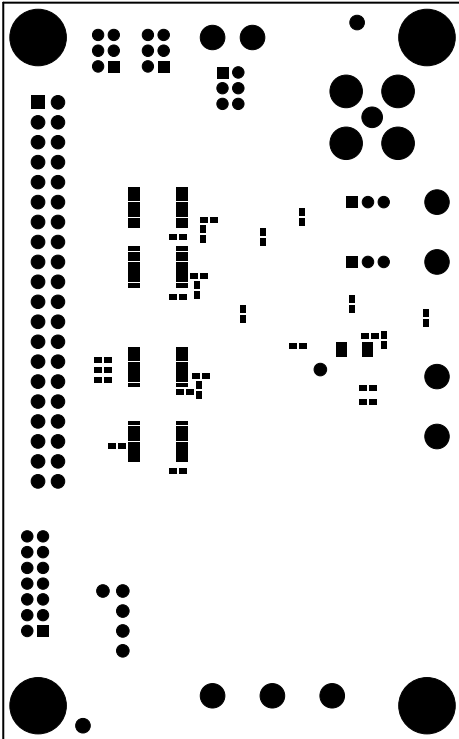

PC FAB DRAWING

REVISIONS			
REV	DESCRIPTION	APPR	DATE
2	3RD PROTOTYPE	LEO C.	07-29-09

SIZE	QTY	SYM	PLATED	TOL
0.07	2	+	NO	+/-0.003"
0.188	4	X	YES	+/-0.003"
0.064	9	□	YES	+/-0.003"
0.012	314	◇	YES	+/-0.003"
0.035	44	⊗	YES	+/-0.003"
0.04	40	⊗	YES	+/-0.003"
0.085	4	⊕	YES	+/-0.003"
0.05	1	⊖	YES	+/-0.003"

NOTES: UNLESS OTHERWISE SPECIFIED

- FAB PER IPC-A-600
- MATERIAL: EPOXY FIBERGLASS, NEMA GRADE FR-4
FINISHED THICKNESS TO BE 0.062" +/- .005"
TOTAL OF 4 LAYERS WITH 2 OZ. CU ON THE
OUTER LAYERS AND 1 OZ. CU ON THE INNER LAYERS.
FLAMMABILITY RATING: 94 V-0 MINIMUM .
- SIZE: CUT TO DIMENSIONS AND TOLERANCES SHOWN.
0.00" ARE PRIMARY DATUMS.
- DRILLING: DRILL HOLES PER SCHEDULE. PLATE THROUGH
HOLES WITH COPPER, 0.001" THICK MIN.
ALL HOLE SIZES ARE SPECIFIED AFTER PLATING.
HOLE LOCATION TOLERANCES ARE +/-0.003"
IN RELATION TO CENTER
- FINISH: SMOBC USING LPI BOTH SIDES, COLOR GREEN.
GOLD IMMERSION. (USE LEAD FREE SOLDER FOR PROTOTYPE)
FOR SILKSCREEN: USE WHITE NON-CONDUCTIVE INK.
- DO NOT ALTER ARTWORK e.g. TO ADD LOGO OR DATE CODE.
PAD SIZE CAN BE MODIFIED TO MEET END FINISH.
- PCBS ARE TO BE ROHS COMPLIANT.
- SCORING FOR PANELIZED PCB:

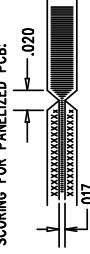

SHOWN FROM COMPONENT SIDE

		1630 MCCARTHY BLVD MILPITAS, CA 95035 PH: (408)432-1900 FAX: (408)432-1901 E-MAIL: SALES@LINEAR.COM WWW.LINEAR.COM FOR CUSTOMER USE ONLY	
APPROVALS		TITLE: FABRICATION DRAWING	
DRAWN CHECK DESIGN ENGR	DATE .07-29-09 LEO C.	18-BIT PARALLEL INPUT, CURRENT OUTPUT DAC WITH READBACK	
SCALE = NONE		SIZE A	DEMO DC1485A-2 * LTC2757CLX
		REV. 2	SHIT 1 of 1

DEMO MANUAL DC1485A

DEMONSTRATION BOARD IMPORTANT NOTICE

Linear Technology Corporation (LTC) provides the enclosed product(s) under the following **AS IS** conditions:

This demonstration board (DEMO BOARD) kit being sold or provided by Linear Technology is intended for use for **ENGINEERING DEVELOPMENT OR EVALUATION PURPOSES ONLY** and is not provided by LTC for commercial use. As such, the DEMO BOARD herein may not be complete in terms of required design-, marketing-, and/or manufacturing-related protective considerations, including but not limited to product safety measures typically found in finished commercial goods. As a prototype, this product does not fall within the scope of the European Union directive on electromagnetic compatibility and therefore may or may not meet the technical requirements of the directive, or other regulations.

If this evaluation kit does not meet the specifications recited in the DEMO BOARD manual the kit may be returned within 30 days from the date of delivery for a full refund. **THE FOREGOING WARRANTY IS THE EXCLUSIVE WARRANTY MADE BY THE SELLER TO BUYER AND IS IN LIEU OF ALL OTHER WARRANTIES, EXPRESSED, IMPLIED, OR STATUTORY, INCLUDING ANY WARRANTY OF MERCHANTABILITY OR FITNESS FOR ANY PARTICULAR PURPOSE. EXCEPT TO THE EXTENT OF THIS INDEMNITY, NEITHER PARTY SHALL BE LIABLE TO THE OTHER FOR ANY INDIRECT, SPECIAL, INCIDENTAL, OR CONSEQUENTIAL DAMAGES.**

The user assumes all responsibility and liability for proper and safe handling of the goods. Further, the user releases LTC from all claims arising from the handling or use of the goods. Due to the open construction of the product, it is the user's responsibility to take any and all appropriate precautions with regard to electrostatic discharge. Also be aware that the products herein may not be regulatory compliant or agency certified (FCC, UL, CE, etc.).

No License is granted under any patent right or other intellectual property whatsoever. **LTC assumes no liability for applications assistance, customer product design, software performance, or infringement of patents or any other intellectual property rights of any kind.**

LTC currently services a variety of customers for products around the world, and therefore this transaction **is not exclusive**.

Please read the DEMO BOARD manual prior to handling the product. Persons handling this product must have electronics training and observe good laboratory practice standards. **Common sense is encouraged.**

This notice contains important safety information about temperatures and voltages. For further safety concerns, please contact a LTC application engineer.

Mailing Address:

Linear Technology
1630 McCarthy Blvd.
Milpitas, CA 95035

Copyright © 2004, Linear Technology Corporation