



Chipsmall Limited consists of a professional team with an average of over 10 year of expertise in the distribution of electronic components. Based in Hongkong, we have already established firm and mutual-benefit business relationships with customers from,Europe,America and south Asia,supplying obsolete and hard-to-find components to meet their specific needs.

With the principle of “Quality Parts,Customers Priority,Honest Operation,and Considerate Service”,our business mainly focus on the distribution of electronic components. Line cards we deal with include Microchip,ALPS,ROHM,Xilinx,Pulse,ON,Everlight and Freescale. Main products comprise IC,Modules,Potentiometer,IC Socket,Relay,Connector.Our parts cover such applications as commercial,industrial, and automotives areas.

We are looking forward to setting up business relationship with you and hope to provide you with the best service and solution. Let us make a better world for our industry!



Contact us

Tel: +86-755-8981 8866 Fax: +86-755-8427 6832

Email & Skype: info@chipsmall.com Web: www.chipsmall.com

Address: A1208, Overseas Decoration Building, #122 Zhenhua RD., Futian, Shenzhen, China



LTM4630EY-1

Dual 18A or Single 36A μModule Regulator

DESCRIPTION

Demonstration circuit 2268A-E is a high efficiency, high density, dual 18A, switch mode step-down power supply on a compact 1.5' × 1.2' PCB. It features the [LTM4630-1](#) μModule regulator. The input voltage is from 4.5V to 15V. The output voltage is programmable from 0.6V to 1.8V. DC2268A-E can deliver up to 18A maximum in each channel. With the help of external compensation, ±3% transient accuracy can be achieved with 25% load step. As explained in the data sheet, output current derating is necessary for certain V_{IN} , V_{OUT} , and thermal conditions. The board operates in continuous conduction mode in heavy load conditions. For high efficiency at low load currents, the resistor jumper (R1/R2) selects pulse-skipping mode for noise sensitive applications or Burst Mode® in less noise sensitive applications. Two outputs can be connected in parallel for a single 36A output solution with optional jumper resistors. The board allows the user to program how its

output ramps up and down through the TRACK/SS pin. Remote output voltage sensing is available for improved output voltage regulation at the load point. An optional input inductor L1 reduces the EMI noise for noise sensitive applications. DC2268A can be easily inserted to an edge connector for testing and debugging. These features and the availability of the LTM4630-1EY in a compact 16mm × 16mm × 5.01mm BGA package make it ideal for use in many high-density point-of-load regulation applications. The LTM4630-1 data sheet must be read in conjunction with this demo manual for working on or modifying the demo circuit DC2268A-E.

Design files for this circuit board are available at <http://www.linear.com/demo/DC2268A-E>

LT, LT, LTC, LTM, Linear Technology, the Linear logo and Burst Mode are registered trademarks of Linear Technology Corporation. All other trademarks are the property of their respective owners.

BOARD PHOTO

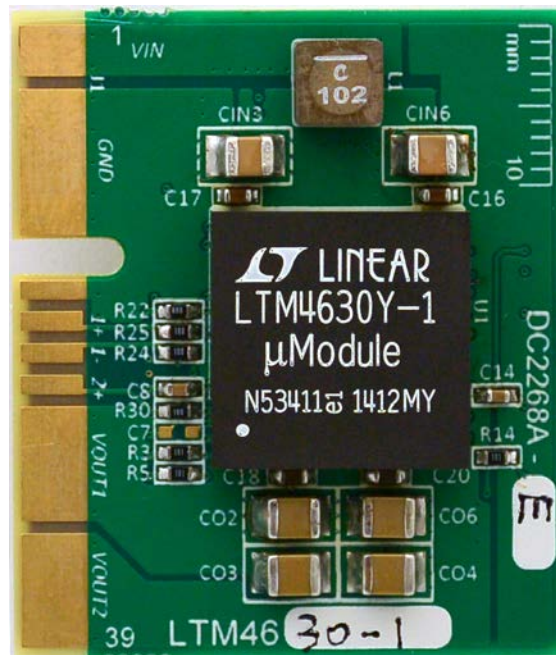

Figure 1. LTM4630-1/DC2268A-E Demo Board

DEMO MANUAL DC2268A-E

PERFORMANCE SUMMARY Specifications are at $T_A = 25^\circ\text{C}$

PARAMETER	CONDITIONS	VALUE
Input Voltage Range		4.5V ~ 15V
Output Voltage V_{OUT1}	$V_{IN} = 4.5V \sim 15V, I_{OUT1} = 0A \sim 18A$	$1.0V \pm 1.5\%$ (0.985V ~ 1.015V)
Output Voltage V_{OUT2}	$V_{IN} = 4.5V \sim 15V, I_{OUT2} = 0A \sim 18A$	$1.5V \pm 1.5\%$ (1.4775V ~ 1.5225V)
Per-Channel Maximum Continuous Output Current	Derating Is Necessary for Certain V_{IN} , V_{OUT} and Thermal Conditions.	18A
Default Operating Frequency		500kHz
Resistor Programmable Frequency Range		250kHz to 780kHz
External Clock Sync. Frequency Range		400kHz to 780kHz
Efficiency of Channel 1	$V_{IN} = 12V, V_{OUT2} = 1.0V, I_{OUT2} = 18A, f_{SW} = 500kHz$	84.0% See Figure 3
Efficiency of Channel 2	$V_{IN} = 12V, V_{OUT1} = 1.5V, I_{OUT1} = 18A, f_{SW} = 500kHz$	87.9% See Figure 4
Load Transient of Channel 1	$V_{IN} = 12V, V_{OUT2} = 1.0V, I_{STEP} = 0A \sim 4.5A$	See Figure 5
Load Transient of Channel 2	$V_{IN} = 12V, V_{OUT1} = 1.5V, I_{STEP} = 0A \sim 4.5A$	See Figure 6

QUICK START PROCEDURE

Demonstration circuit DC2268A-E is easy to set up to evaluate the performance of the LTM4630EY-1. It can be easily inserted to an edge connector (SAMTEC MEC2-20-01-L-DV--TR) for testing and debugging. Please refer to Figure 2 for proper measurement setup and follow the procedure below:

1. Pull up the RUN1 (J1 pin 22) and RUN2 (J1 pin 24) between 1.4V to 5V or leave them floating.
2. With power off, connect the input power supply, load and meters as shown in Figure 1. Preset the load to 0A and V_{IN} supply to 12V.
3. Turn on the power supply at the input. The output voltage in channel 1 should be $1.0V \pm 1.5\%$ (0.985V ~ 1.015V) and the output voltage in channel 2 should be $1.5V \pm 1.5\%$ (1.4775V ~ 1.5225V),
4. Once the proper output voltage is established, adjust the load within the operating range and observe the output voltage regulation, output voltage ripple, efficiency and other parameters. Output ripple should be measured at Co3 and Co4.
5. (Optional) LTM4630EY-1 can be synchronized to an external clock signal. Remove R2 and apply a clock signal (0~5V, square wave) to MODE-PLLIN pin.
6. (Optional) LTM4630EY-1 can be configured for a 2-phase single output at up to 36A on DC2268A-E. Install 0 Ω resistors on R26, R27, R28, R29, R32, and remove R14, R18 R30. Output voltage is set by R7 based on equation $V_{OUT} = 0.6V(1 + 60.4k/R7)$.

QUICK START PROCEDURE

Table 2. DC2268A Demo Circuit

DEMO BOARD NUMBER	μMODULE REGULATOR ON THE BOARD	OUTPUT CURRENT
DC2268A-A	LTM4620	13A, 13A
DC2268A-B	LTM4620A	13A, 13A
DC2268A-C	LTM4628	8A, 8A
DC2268A-D	LTM4630	18A, 18A
DC2268A-E	LTM4630-1	18A, 18A
DC2268A-F	LTM4630A	18A, 18A
DC2268A-G	LTM4631	10A, 10A

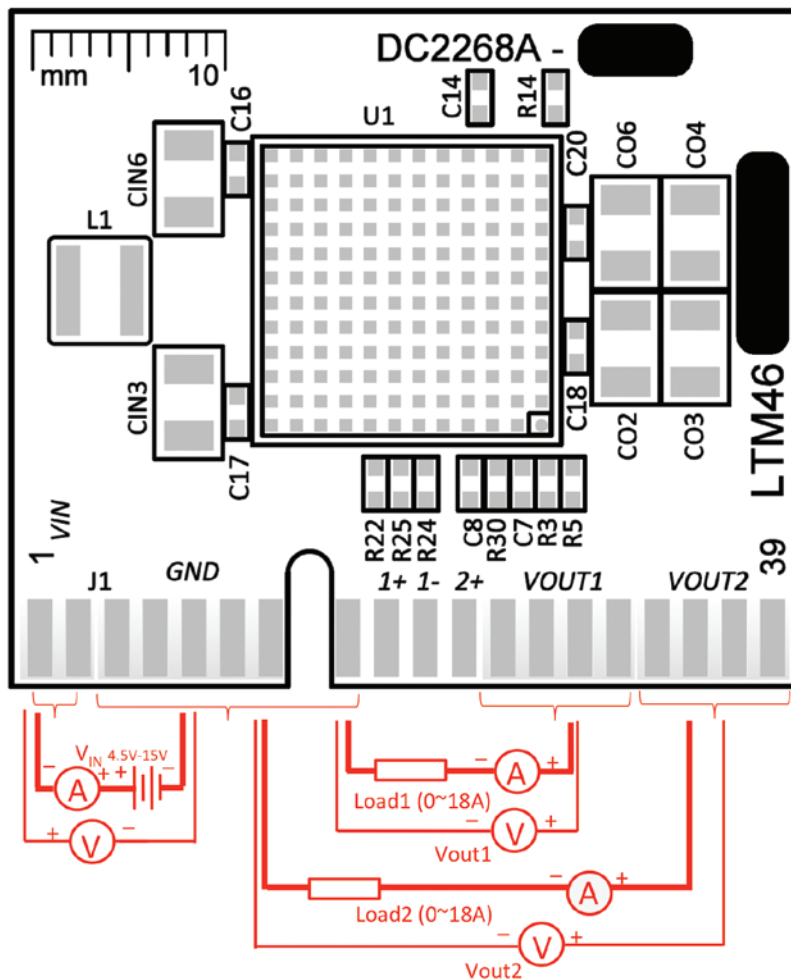

Figure 2. Test Setup of DC2268A-E

QUICK START PROCEDURE

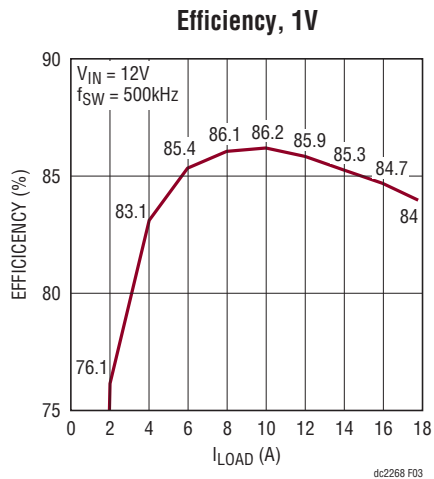

Figure 3. Measured Efficiency on Channel 1 ($V_{OUT1} = 1.0V$, $f_{SW} = 500kHz$, Channel 2 Disabled)

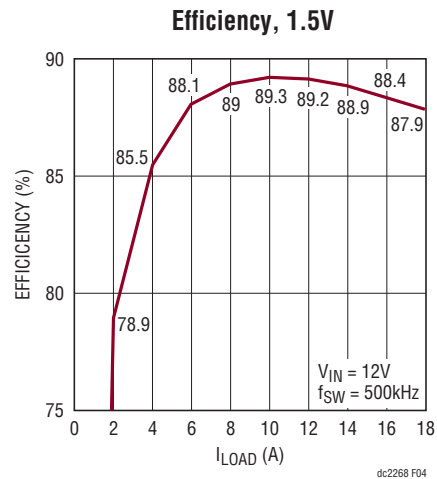

Figure 4. Measured Efficiency on Channel 2 ($V_{OUT2} = 1.5V$, $f_{SW} = 500kHz$, Channel 1 Disabled)

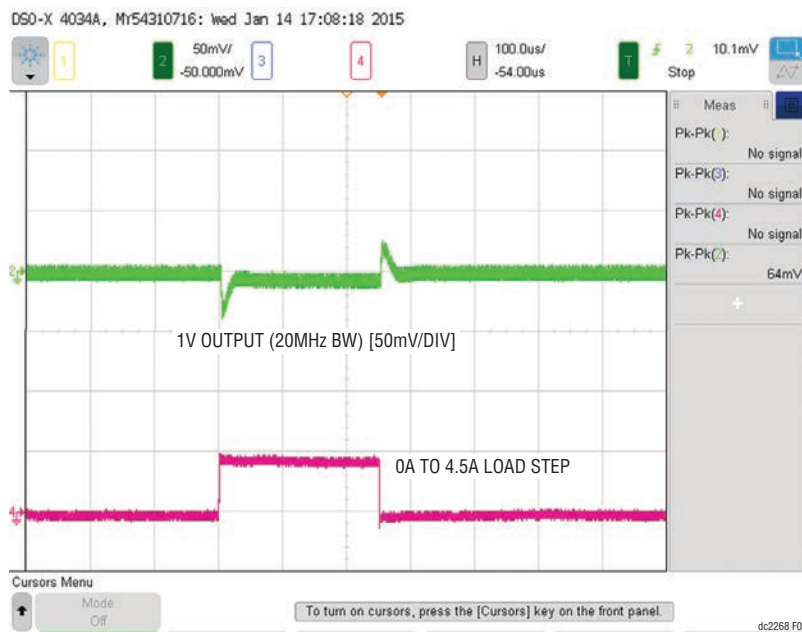

Figure 5. Measured Channel 1 0A to 4.5A Load Transient ($V_{IN} = 12V$, $V_{OUT1} = 1.0V$)

QUICK START PROCEDURE

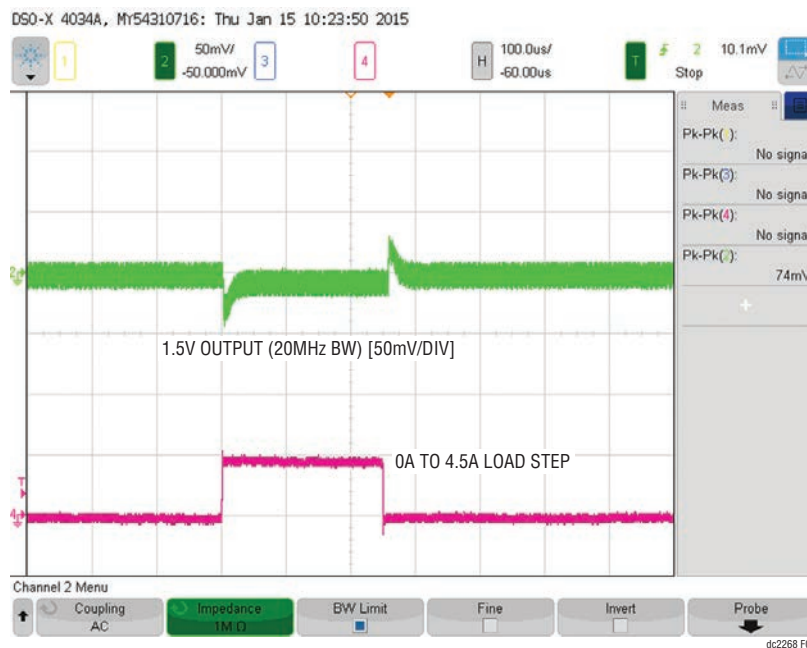

Figure 6. Measured Channel 2 0A to 4.5A Load Transient ($V_{IN} = 12V$, $V_{OUT2} = 1.5V$)

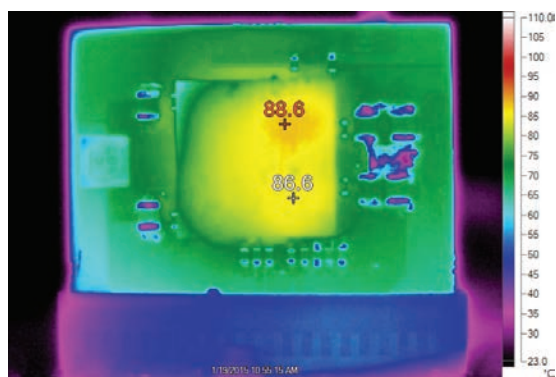
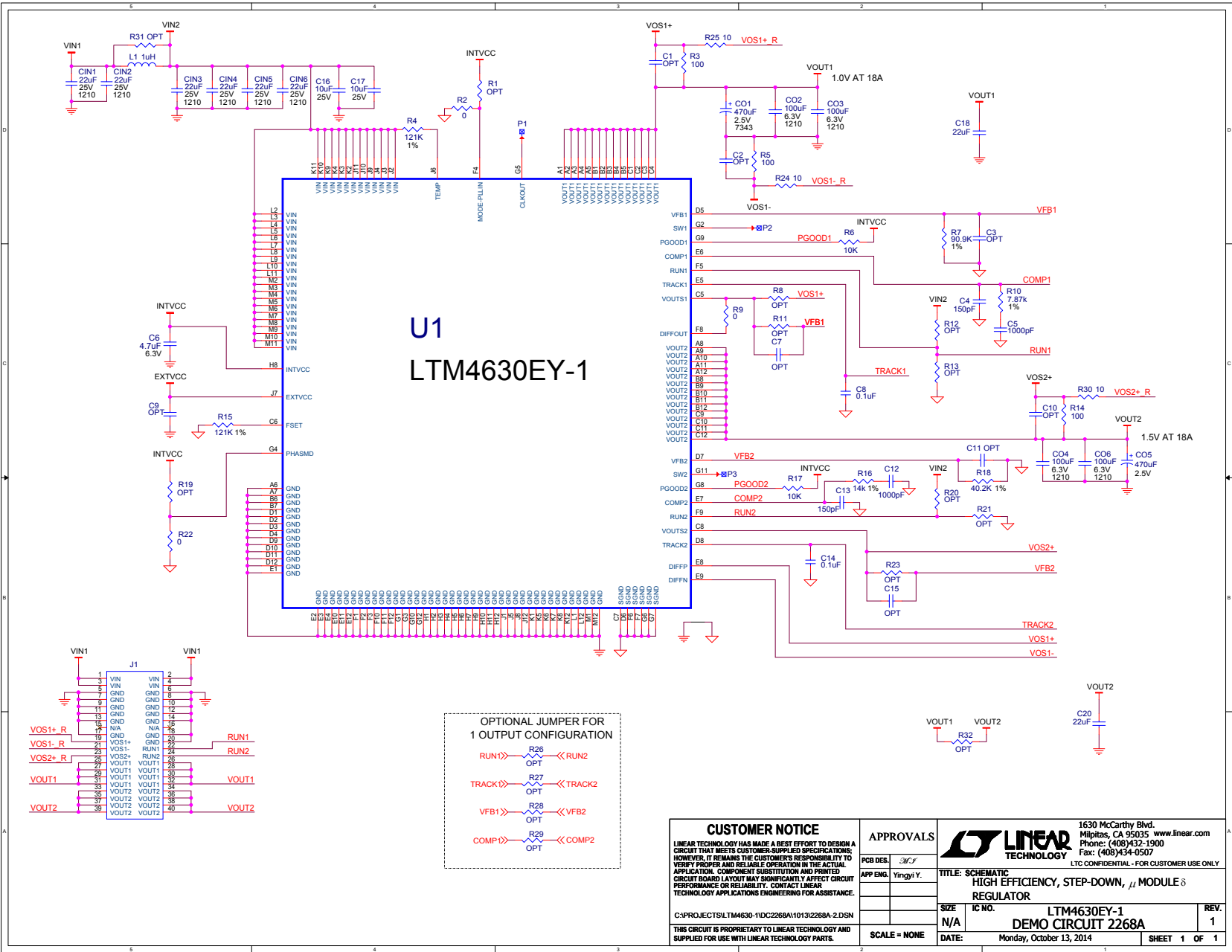

Figure 7. Thermal Performance at $V_{IN} = 12V$, $V_{OUT1} = 1.0V/14A$, $V_{OUT2} = 1.5V/14A$, $f_{SW} = 500kHz$, $T_A = 23^\circ C$, 200LFM Airflow

DEMO MANUAL DC2268A-E

PARTS LIST

ITEM	QTY	REFERENCE	PART DESCRIPTION	MANUFACTURER/PART NUMBER
Required Circuit Components				
1	6	CIN1, CIN2, CIN3, CIN4, CIN5, CIN6	CAP, 1210 22µF 10% 25V X5R	AVX 12103D226KAT2A
2	2	C01, C05	CAP, 7343 470µF 20% 2.5V POSCAP	PANASONIC ETPF470M5H
3	4	C02, C03, C04, C06	CAP, 1210 100µF 10% 6.3V X5R	AVX 12106D107KAT2A
4	2	C4, C13	CAP, 0603 150pF 5% 16V C0G	AVX 0603YA151JAT2A
5	2	C5, C12	CAP, 0603 1000pF 5% 16V C0G	AVX 0603YA102JAT2A
6	1	C6	CAP, 0603 4.7µF 20% 6.3V X5R	AVX 06036D475MAT2A
7	2	C8, C14	CAP, 0603 0.1µF 10% 25V X7R	AVX 06033C104KAT2A
8	2	C16, C17	CAP, 0603 10µF 20% 25V X5R	TDK C1608X5R1E106M080AC
9	2	C18, C20	CAP, 0603 22µF 20% 6.3V X5R	TDK C1608X5R0J226M080AC
10	1	L1	IND, 1.0µH	COILCRAFT XAL5030-102MEC
11	3	R2, R9, R22	RES, 0603 0Ω JUMPER	VISHAY CRCW06030000Z0EA
12	3	R3, R5, R14	RES, 0603 100Ω 5% 0.1W	VISHAY CRCW0603100RJNEA
13	2	R4, R15	RES, 0603 121k 1% 0.1W	VISHAY CRCW0603121KFKEA
14	2	R6, R17	RES, 0603 10k 5% 0.1W	VISHAY CRCW060310K0JNEA
15	1	R7	RES, 0603 90.9k 1% 0.1W	VISHAY CRCW060390K9FKEA
16	1	R10	RES, 0603 7.87k 1% 1/10W	VISHAY CRCW06037K87FKEA
17	1	R16	RES, 0603 14k 1% 0.1W	VISHAY CRCW060314K0FKEA
18	1	R18	RES, 0603 40.2k 1% 0.1W	VISHAY CRCW060340K2FKEA
19	3	R24, R25, R30	RES, 0603 10Ω 5% 0.1W	VISHAY CRCW060310R0JNEA
20	1	U1	IC, VOLTAGE REGULATOR LGA	LINEAR TECH. LTM4630-1EV#PBF
Additional Demo Board Circuit Components				
1	0	C1, C2, C3, C7, C9, C10, C11, C15	CAP, 0603 OPTION	OPTION
2	0	R1, R8, R11, R12, R13, R16, R19, R20, R21, R23, R26, R27, R28, R29	RES, 0603 OPTION	OPTION
3	0	R31, R32	RES, 2512 OPTION	OPTION
Hardware: For Demo Board Only				
1	1	J1	CONN., CARD EDGE 1.6mm	SAMTEC MEC2-20-01-L-DV--TR



CUSTOMER NOTICE
 LINEAR TECHNOLOGY HAS MADE A BEST EFFORT TO DESIGN A CIRCUIT THAT MEETS CUSTOMER-SUPPLIED SPECIFICATIONS; HOWEVER, IT REMAINS THE CUSTOMER'S RESPONSIBILITY TO VERIFY PROPER AND RELIABLE OPERATION IN THE ACTUAL APPLICATION. COMPONENT SUBSTITUTION AND PRINTED CIRCUIT BOARD LAYOUT MAY SIGNIFICANTLY AFFECT CIRCUIT PERFORMANCE OR RELIABILITY. CONTACT LINEAR TECHNOLOGY APPLICATIONS ENGINEERING FOR ASSISTANCE.

C:\PROJECTS\LTM4630-1\DC2268A\1013\2268A-2.DSN
 THIS CIRCUIT IS PROPRIETARY TO LINEAR TECHNOLOGY AND SUPPLIED FOR USE WITH LINEAR TECHNOLOGY PARTS.

APPROVALS	
PCB DES.	YMG
APP ENG.	Yingyi Y.
SCALE	NONE

	1630 McCarthy Blvd. Milpitas, CA 95035 www.linear.com Phone: (408)432-1900 Fax: (408)434-0507	
	LTC CONFIDENTIAL - FOR CUSTOMER USE ONLY	
TITLE: SCHEMATIC HIGH EFFICIENCY, STEP-DOWN, μ MODULE δ REGULATOR		
SIZE N/A IC NO. LTM4630EY-1 DEMO CIRCUIT 2268A	DATE: Monday, October 13, 2014	REV. 1 SHEET 1 OF 1

DEMO MANUAL DC2268A-E

DEMONSTRATION BOARD IMPORTANT NOTICE

Linear Technology Corporation (LTC) provides the enclosed product(s) under the following **AS IS** conditions:

This demonstration board (DEMO BOARD) kit being sold or provided by Linear Technology is intended for use for **ENGINEERING DEVELOPMENT OR EVALUATION PURPOSES ONLY** and is not provided by LTC for commercial use. As such, the DEMO BOARD herein may not be complete in terms of required design-, marketing-, and/or manufacturing-related protective considerations, including but not limited to product safety measures typically found in finished commercial goods. As a prototype, this product does not fall within the scope of the European Union directive on electromagnetic compatibility and therefore may or may not meet the technical requirements of the directive, or other regulations.

If this evaluation kit does not meet the specifications recited in the DEMO BOARD manual the kit may be returned within 30 days from the date of delivery for a full refund. **THE FOREGOING WARRANTY IS THE EXCLUSIVE WARRANTY MADE BY THE SELLER TO BUYER AND IS IN LIEU OF ALL OTHER WARRANTIES, EXPRESSED, IMPLIED, OR STATUTORY, INCLUDING ANY WARRANTY OF MERCHANTABILITY OR FITNESS FOR ANY PARTICULAR PURPOSE. EXCEPT TO THE EXTENT OF THIS INDEMNITY, NEITHER PARTY SHALL BE LIABLE TO THE OTHER FOR ANY INDIRECT, SPECIAL, INCIDENTAL, OR CONSEQUENTIAL DAMAGES.**

The user assumes all responsibility and liability for proper and safe handling of the goods. Further, the user releases LTC from all claims arising from the handling or use of the goods. Due to the open construction of the product, it is the user's responsibility to take any and all appropriate precautions with regard to electrostatic discharge. Also be aware that the products herein may not be regulatory compliant or agency certified (FCC, UL, CE, etc.).

No License is granted under any patent right or other intellectual property whatsoever. **LTC assumes no liability for applications assistance, customer product design, software performance, or infringement of patents or any other intellectual property rights of any kind.**

LTC currently services a variety of customers for products around the world, and therefore this transaction **is not exclusive**.

Please read the DEMO BOARD manual prior to handling the product. Persons handling this product must have electronics training and observe good laboratory practice standards. **Common sense is encouraged.**

This notice contains important safety information about temperatures and voltages. For further safety concerns, please contact a LTC application engineer.

Mailing Address:

Linear Technology
1630 McCarthy Blvd.
Milpitas, CA 95035

Copyright © 2004, Linear Technology Corporation