



Chipsmall Limited consists of a professional team with an average of over 10 year of expertise in the distribution of electronic components. Based in Hongkong, we have already established firm and mutual-benefit business relationships with customers from,Europe,America and south Asia,supplying obsolete and hard-to-find components to meet their specific needs.

With the principle of "Quality Parts,Customers Priority,Honest Operation,and Considerate Service",our business mainly focus on the distribution of electronic components. Line cards we deal with include Microchip,ALPS,ROHM,Xilinx,Pulse,ON,Everlight and Freescale. Main products comprise IC,Modules,Potentiometer,IC Socket,Relay,Connector.Our parts cover such applications as commercial,industrial, and automotives areas.

We are looking forward to setting up business relationship with you and hope to provide you with the best service and solution. Let us make a better world for our industry!



Contact us

Tel: +86-755-8981 8866 Fax: +86-755-8427 6832

Email & Skype: info@chipsmall.com Web: www.chipsmall.com

Address: A1208, Overseas Decoration Building, #122 Zhenhua RD., Futian, Shenzhen, China



LTM8068
**Isolated μ Module DC/DC Converter
with LDO Regulator**
DESCRIPTION

The Demo Circuit 2358A is a 2kV AC isolated flyback μ Module[®] DC/DC converter with LDO post regulator featuring the **LTM8068**. The demo circuit is designed for a 5.6V flyback output and a 5V post regulator output from a 4.5V to 40V input. The current capability of the 5.6V flyback output varies with input voltage from about 200mA at 4.5V_{IN} to about 460mA at 40V_{IN}. The current capability of the 5V LDO output is limited by either the current capability of V_{OUT1} minus V_{OUT1} loading or the 300mA current limit on the LDO post regulator itself. Figure 1 shows the maximum output current on V_{OUT1} when V_{OUT2} is not loaded, and V_{OUT2} when V_{OUT1} is unloaded. V_{OUT2} is the LDO post regulator from V_{OUT1}.

The two-stage converter provides an isolated flyback output as well as a low-noise LDO output. Figure 2 shows the output noise spectrum on the flyback output and Figure 3 shows the output noise spectrum on the LDO output.

The LTM8068 data sheet gives complete description of the device, operation and application information. The data sheet must be read in conjunction with this quick start guide for demo circuit 2358A.

Design files for this circuit board are available at <http://www.linear.com/demo/DC2358A>

LT, LT, LTC, LTM, Linear Technology, the Linear logo and μ Module are registered trademarks of Linear Technology Corporation. All other trademarks are the property of their respective owners.

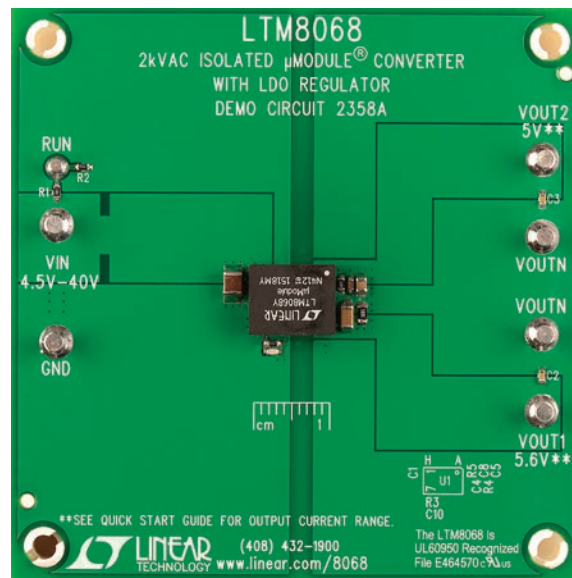
BOARD PHOTO

DEMO MANUAL DC2358A

PERFORMANCE SUMMARY Specifications are at $T_A = 25^\circ\text{C}$

PARAMETER	CONDITIONS	MIN	TYP	MAX	UNITS
Minimum Input Voltage				4.5	V
Maximum Input Voltage		40			V
Output Voltage V_{OUT1}	$V_{IN} = 4.5\text{V to } 40\text{V}$	5.3	5.6	5.9	V
Output Voltage V_{OUT2}	$V_{IN} = 4.5\text{V to } 40\text{V}$	4.85	5	5.15	V
Voltage Ripple V_{OUT1}	$V_{IN} = 12\text{V}, I_{OUT1} = 200\text{mA}, I_{OUT2} = 0\text{mA}$		25		mV
Voltage Ripple V_{OUT2}	$V_{IN} = 12\text{V}, I_{OUT1} = 0\text{mA}, I_{OUT2} = 200\text{mA}$		1		mV

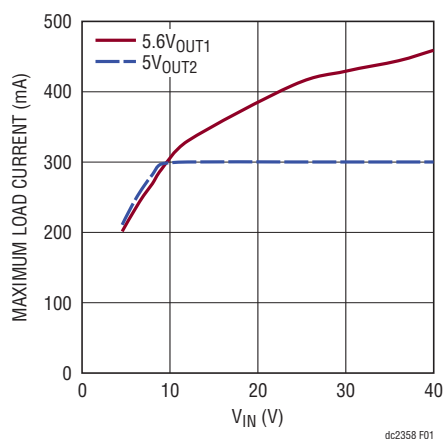

Figure 1. Maximum Output Current vs V_{IN} : 5.6 V_{OUT1} Flyback Output with V_{OUT2} Unloaded; 5 V_{OUT2} LDO output with V_{OUT1} Unloaded

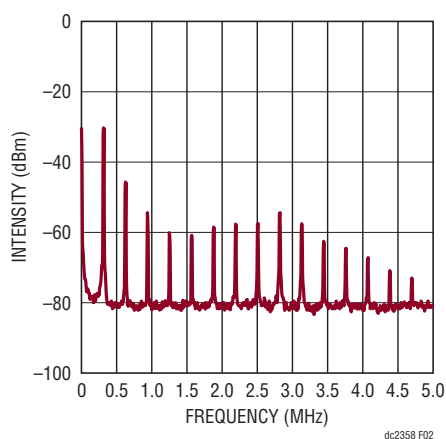

Figure 2. V_{OUT1} Output Noise Spectrum with I_{OUT1} at 200mA and V_{IN} at 12V (V_{OUT2} Has No Extra Load)

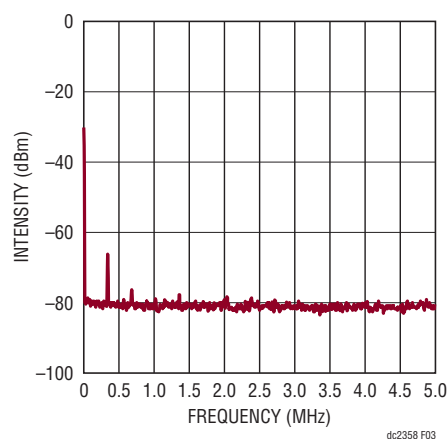

Figure 3. V_{OUT2} Output Noise Spectrum with I_{OUT2} at 200mA and V_{IN} at 12V (V_{OUT1} Has No Extra Load)

QUICK START PROCEDURE

Demo circuit 2358A is easy to set up to evaluate the performance of the LTM8068. Refer to Figure 4 for proper measurement equipment setup and follow the procedure below:

NOTE: When measuring the input or output voltage ripple, care must be taken to avoid a long ground lead on the oscilloscope probe. Measure the input or output voltage ripple by touching the probe tip directly across the V_{IN} and GND or V_{OUT} and V_{OUTN} terminals. See Figure 5 for proper scope probe technique.

1. With power off, connect the input power supply to V_{IN} and GND.

2. Turn on the power at the input.

NOTE. Make sure that the input voltage does not exceed 40V.

3. Check for the proper output voltages. (For $OUT1$, check the voltage between V_{OUT1} and V_{OUTN} . For $OUT2$, check the voltage between V_{OUT2} and V_{OUTN} .)

NOTE: If there is no output, temporarily disconnect the load to make sure that the load is not set too high.

4. Once the proper output voltages are established, adjust the load within the operating range and observe the output voltage regulation, ripple voltage, efficiency and other parameters.

dc2358af

QUICK START PROCEDURE

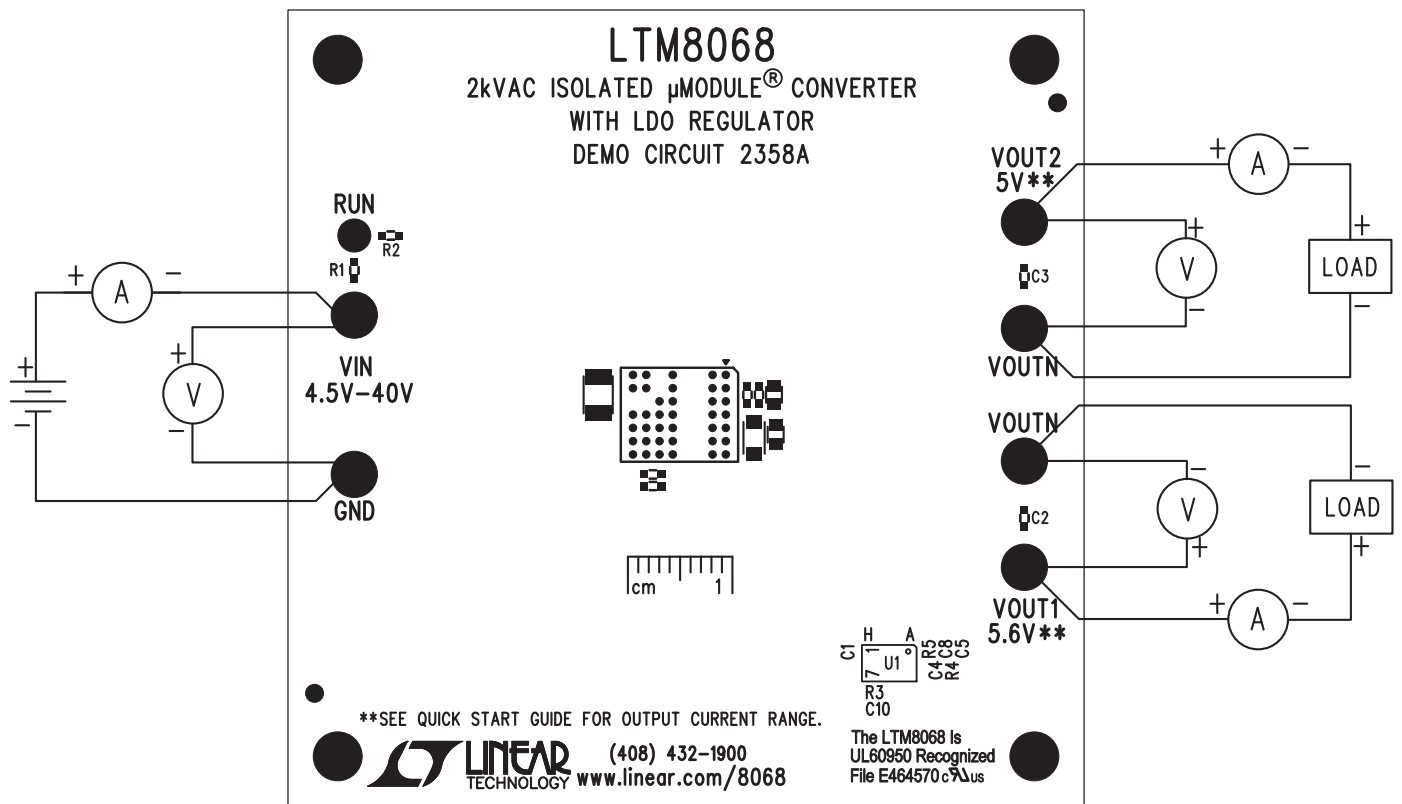

Figure 4. DC2358A Proper Equipment Setup

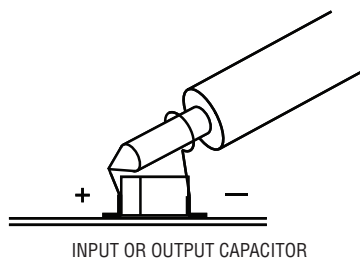

Figure 5. Measuring Input or Output Ripple

DEMO MANUAL DC2358A

PARTS LIST

ITEM	QTY	REFERENCE	PART DESCRIPTION	MANUFACTURER/PART NUMBER
Required Circuit Components				
1	1	CIN1	CAP, ALUM, 22µF, 50V, 6.6x6.6mm	NICHICON, UUD1H220MCL1GS
2	1	C1	CAP, CER., 10µF, X7R, 50V, 10%, 1210	MURATA, GRM32ER71H106KA12L
3	2	C2, C3	CAP, CER., 4.7µF, X5R, 10V, 10%, 0603	MURATA, GRM188R61A475KE15D
4	1	C4	CAP, CER., 47µF, X5R, 10V, 10%, 1206	MURATA, GRM31CR61A476KE15L
5	1	C5	CAP, CER., 22µF, X5R, 6.3V, 20%, 0805	MURATA, GRM21BR60J226ME39L
6	1	C8	CAP, CER., 0.01µF, X7R, 25V, 10%, 0603	MURATA, GRM188R71E103KA01D
7	1	C10	CAP, CER., 10pF, NPO, 50V, 5%, 0603	MURATA, GRM1885C1H100JA01D
8	1	R1	RES, 200k, 1/10W, 1%, 0603	VISHAY, CRCW0603200KFKEA
9	1	R2	RES, 95.3k, 1/10W, 1%, 0603	VISHAY, CRCW060395K3FKEA
10	1	R3	RES, 7.32k, 1/10W, 1%, 0603	VISHAY, CRCW06037K32FKEA
11	1	R4	RES, 604Ω, 1/8W, 1%, 0805	VISHAY, CRCW0805604RFKEA
12	1	R5	RES, 162k, 1/10W, 1%, 0603	VISHAY, CRCW0603162KFKEA
13	1	U1	I.C., LTM8068EY#PBF 9 × 11.25 × 4.92 BGA	LINEAR TECH., LTM8068EY#PBF
Additional Demo Board Circuit Components				
1	0	C6 (OPT)	CAP, 1210 (OPT)	
2	0	C7 (OPT)	CAP, 0805 (OPT)	
3	0	C9 (OPT)	CAP, 1808 (OPT)	
4	0	L1 (OPT)	IND., 10µH, XFL3012 (OPT)	
Hardware: For Demo Board Only				
1	6	E1-E6	TESTPOINT, TURRET, 0.094" pbf	MILL-MAX, 2501-2-00-80-00-00-07-0
2	1	E7	TEST POINT, TURRET, 0.064" MTH HOLE	MILL-MAX, 2308-2-00-80-00-00-07-0
3	4	MH1-MH4	STAND-OFF, NYLON 0.375" SNAP ON	KEYSTONE, 8832

SCHEMATIC DIAGRAM

DEMO MANUAL DC2358A

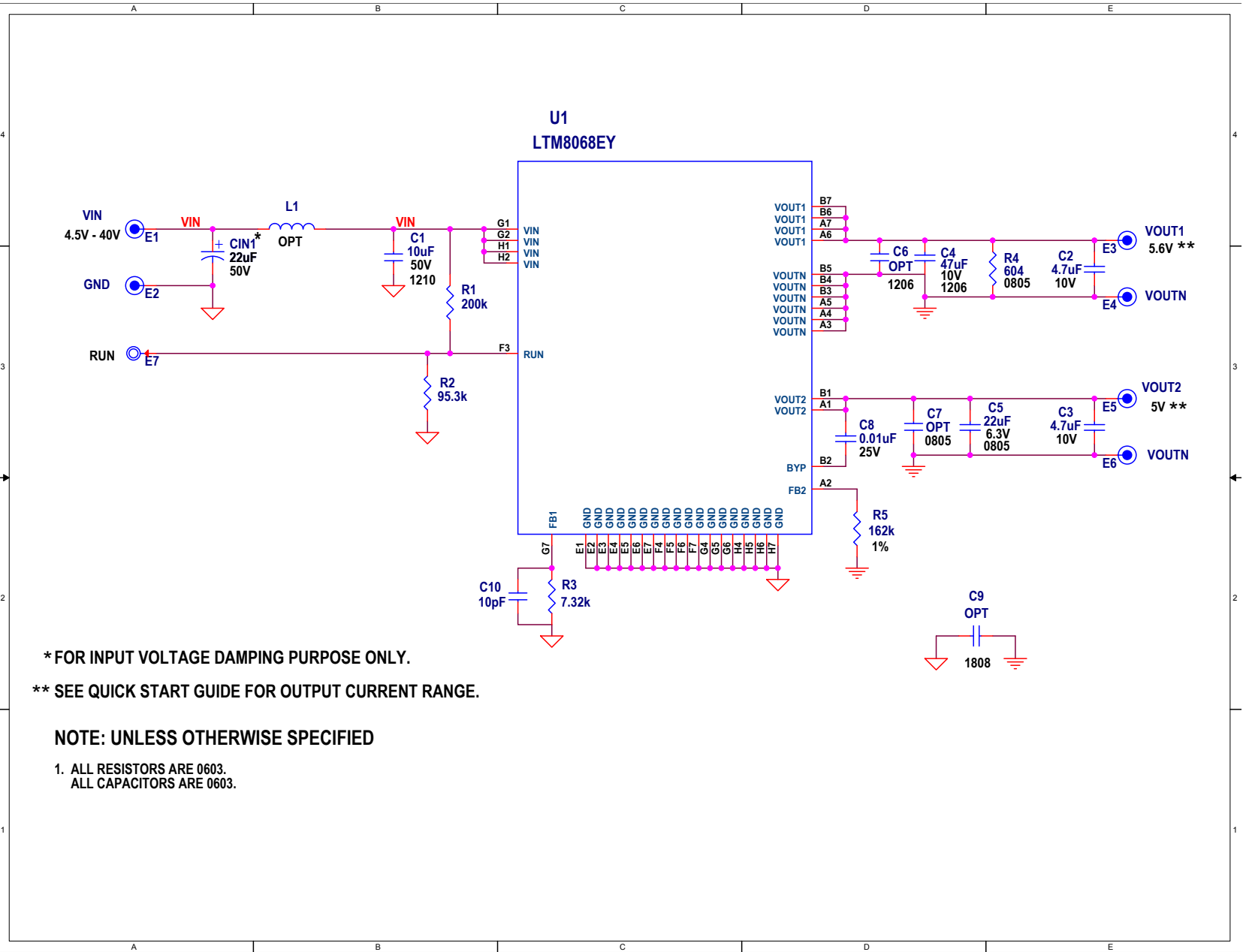

* FOR INPUT VOLTAGE DAMPING PURPOSE ONLY.

** SEE QUICK START GUIDE FOR OUTPUT CURRENT RANGE.

NOTE: UNLESS OTHERWISE SPECIFIED

1. ALL RESISTORS ARE 0603.
ALL CAPACITORS ARE 0603.

DEMO MANUAL DC2358A

DEMONSTRATION BOARD IMPORTANT NOTICE

Linear Technology Corporation (LTC) provides the enclosed product(s) under the following **AS IS** conditions:

This demonstration board (DEMO BOARD) kit being sold or provided by Linear Technology is intended for use for **ENGINEERING DEVELOPMENT OR EVALUATION PURPOSES ONLY** and is not provided by LTC for commercial use. As such, the DEMO BOARD herein may not be complete in terms of required design-, marketing-, and/or manufacturing-related protective considerations, including but not limited to product safety measures typically found in finished commercial goods. As a prototype, this product does not fall within the scope of the European Union directive on electromagnetic compatibility and therefore may or may not meet the technical requirements of the directive, or other regulations.

If this evaluation kit does not meet the specifications recited in the DEMO BOARD manual the kit may be returned within 30 days from the date of delivery for a full refund. **THE FOREGOING WARRANTY IS THE EXCLUSIVE WARRANTY MADE BY THE SELLER TO BUYER AND IS IN LIEU OF ALL OTHER WARRANTIES, EXPRESSED, IMPLIED, OR STATUTORY, INCLUDING ANY WARRANTY OF MERCHANTABILITY OR FITNESS FOR ANY PARTICULAR PURPOSE. EXCEPT TO THE EXTENT OF THIS INDEMNITY, NEITHER PARTY SHALL BE LIABLE TO THE OTHER FOR ANY INDIRECT, SPECIAL, INCIDENTAL, OR CONSEQUENTIAL DAMAGES.**

The user assumes all responsibility and liability for proper and safe handling of the goods. Further, the user releases LTC from all claims arising from the handling or use of the goods. Due to the open construction of the product, it is the user's responsibility to take any and all appropriate precautions with regard to electrostatic discharge. Also be aware that the products herein may not be regulatory compliant or agency certified (FCC, UL, CE, etc.).

No License is granted under any patent right or other intellectual property whatsoever. **LTC assumes no liability for applications assistance, customer product design, software performance, or infringement of patents or any other intellectual property rights of any kind.**

LTC currently services a variety of customers for products around the world, and therefore this transaction **is not exclusive**.

Please read the DEMO BOARD manual prior to handling the product. Persons handling this product must have electronics training and observe good laboratory practice standards. **Common sense is encouraged.**

This notice contains important safety information about temperatures and voltages. For further safety concerns, please contact a LTC application engineer.

Mailing Address:

Linear Technology
1630 McCarthy Blvd.
Milpitas, CA 95035

Copyright © 2004, Linear Technology Corporation