



Chipsmall Limited consists of a professional team with an average of over 10 year of expertise in the distribution of electronic components. Based in Hongkong, we have already established firm and mutual-benefit business relationships with customers from,Europe,America and south Asia,supplying obsolete and hard-to-find components to meet their specific needs.

With the principle of “Quality Parts,Customers Priority,Honest Operation,and Considerate Service”,our business mainly focus on the distribution of electronic components. Line cards we deal with include Microchip,ALPS,ROHM,Xilinx,Pulse,ON,Everlight and Freescale. Main products comprise IC,Modules,Potentiometer,IC Socket,Relay,Connector.Our parts cover such applications as commercial,industrial, and automotives areas.

We are looking forward to setting up business relationship with you and hope to provide you with the best service and solution. Let us make a better world for our industry!



## Contact us

Tel: +86-755-8981 8866 Fax: +86-755-8427 6832

Email & Skype: info@chipsmall.com Web: www.chipsmall.com

Address: A1208, Overseas Decoration Building, #122 Zhenhua RD., Futian, Shenzhen, China



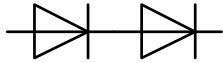

### Key Parameters

$V_{RRM}$	1600V
$I_{FAVM}$	226A ( $T_C = 85^\circ\text{C}$ )
$I_{FSM}$	5750A
$V_{T0}$	0,85V
$r_T$	0,95m $\Omega$
$R_{thJC}$	0,14K/W
Base plate	34mm
Weight	165g



For type designation please refer to actual  
short form catalog

<http://www.ifbip.com/catalog>

### Merkmale

- Löt-Bond Technologie
- Industrie-Standard-Gehäuse
- Elektrisch isolierte Bodenplatte

### Features

- Solder-Bond Technology
- Industrial standard package
- Electrically insulated base plate

### Typische Anwendungen

- Gleichrichter für Antriebsapplikationen
- Gleichrichter für UPS
- Batterieladegleichrichter

### Typical Applications

- Rectifier for drives applications
- Rectifiers for UPS
- Battery chargers

	DMX code digit	DMX code digit quantity
		
content of customer DMX code		
type designation	1..18	18
serial number	19..23	5
internal production order number	24..31	8
material number	32..41	10
date code (YY/WW)	42..45	4
add on for date code	46	1

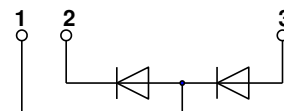

[www.ifbip.com](http://www.ifbip.com)  
[support@infineon-bip.com](mailto:support@infineon-bip.com)

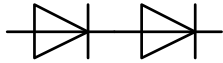

## Technische Information / technical information



**Netz-Dioden-Modul**  
**Rectifier Diode Module**

# DD180N16S

Infineon Technologies Bipolar  
GmbH & Co. KG

### Elektrische Eigenschaften / Electrical properties

Höchstzulässige Werte / Maximum rated values

Periodische Spitzensperrspannung repetitive peak reverse voltages	$T_{vj} = -40^{\circ}\text{C} \dots T_{vj\text{max}}$	$V_{RRM}$	1600	V
Stoßspitzensperrspannung non-repetitive peak reverse voltage	$T_{vj} = +25^{\circ}\text{C} \dots T_{vj\text{max}}$	$V_{RSM}$	1700	V
Durchlaßstrom-Grenzeffektivwert maximum RMS on-state current		$I_{FRMSM}$	275	A
Dauergrenzstrom average on-state current	$T_C = 85^{\circ}\text{C}$ $T_C = 100^{\circ}\text{C}$	$I_{FAVM}$	226 174	A A
Stoßstrom-Grenzwert surge current	$T_{vj} = 25^{\circ}\text{C}, t_p = 10\text{ms}$ $T_{vj} = T_{vj\text{max}}, t_p = 10\text{ms}$	$I_{FSM}$	5750 5000	A A
Grenzlastintegral $I^2t$ -value	$T_{vj} = 25^{\circ}\text{C}, t_p = 10\text{ms}$ $T_{vj} = T_{vj\text{max}}, t_p = 10\text{ms}$	$I^2t$	165313 125000	$\text{A}^2\text{s}$ $\text{A}^2\text{s}$

### Charakteristische Werte / Characteristic values

Durchlaßspannung on-state voltage	$T_{vj} = T_{vj\text{max}}, i_F = 500\text{A}$	$V_F$	max. 1,39	V
Schleusenspannung threshold voltage	$T_{vj} = T_{vj\text{max}}$	$V_{(TO)}$	max. 0,85	V
Ersatzwiderstand slope resistance	$T_{vj} = T_{vj\text{max}}$	$r_T$	max. 0,95	$\text{m}\Omega$
Sperrstrom reverse current	$T_{vj} = T_{vj\text{max}}, V_R = V_{RRM}$	$i_R$	max. 1	$\text{mA}$
Isolations-Prüfspannung insulation test voltage	RMS, $f = 50\text{Hz}, t = 1\text{sec}$ RMS, $f = 50\text{Hz}, t = 1\text{min}$	$V_{ISOL}$	3,6 3	$\text{kV}$ $\text{kV}$

### Thermische Eigenschaften / Thermal properties

Innerer Wärmewiderstand thermal resistance, junction to case	pro Modul / per Module, $\Theta = 180^{\circ}\text{sin}$	$R_{thJC}$	max. 0,08	K/W
	pro Zweig / per arm, $\Theta = 180^{\circ}\text{sin}$		max. 0,16	K/W
	pro Modul / per Module, DC	max. 0,07	K/W	
	pro Zweig / per arm, DC		max. 0,14	K/W
Übergangs-Wärmewiderstand thermal resistance, case to heatsink	pro Modul / per Module	$R_{thCH}$	max. 0,04	K/W
	pro Zweig / per arm		max. 0,08	K/W
Höchstzulässige Sperrschichttemperatur maximum junction temperature		$T_{vj\text{max}}$	135	$^{\circ}\text{C}$
Betriebstemperatur operating temperature		$T_{c\text{op}}$	- 40...+135	$^{\circ}\text{C}$
Lagertemperatur storage temperature		$T_{stg}$	- 40...+135	$^{\circ}\text{C}$

prepared by: AG		date of publication: 2017-08-24
approved by: MS		revision: 3.3

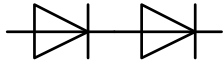

Technische Information /  
technical information



Netz-Dioden-Modul  
Rectifier Diode Module

**DD180N16S**

Infineon Technologies Bipolar  
GmbH & Co. KG

**Mechanische Eigenschaften / Mechanical properties**

Gehäuse, siehe Anlage case, see annex			Seite 4 page 4	
Innere Isolation internal insulation	Basisisolierung (Schutzklasse 1, EN 61140) Basic insulation (class 1, IEC 61140)		Al <sub>2</sub> O <sub>3</sub>	
Anzugsdrehmoment für mechanische Anschlüsse mounting torque	Toleranz ±15%	M1	5	Nm
Anzugsdrehmoment für elektrische Anschlüsse terminal connection torque	Toleranz ±10%	M2	5	Nm
Gewicht weight		G	typ. 165	g
Kriechstrecke creepage distance			10	mm
Schwingfestigkeit vibration resistance	f = 50Hz		50	m/s <sup>2</sup>
	file-No.		E 83335	

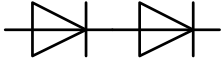

Technische Information /  
technical information



Netz-Dioden-Modul  
Rectifier Diode Module

**DD180N16S**

Infineon Technologies Bipolar  
GmbH & Co. KG

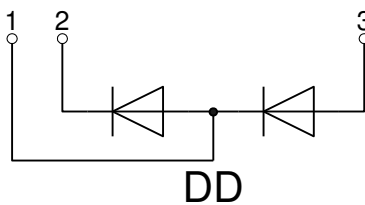
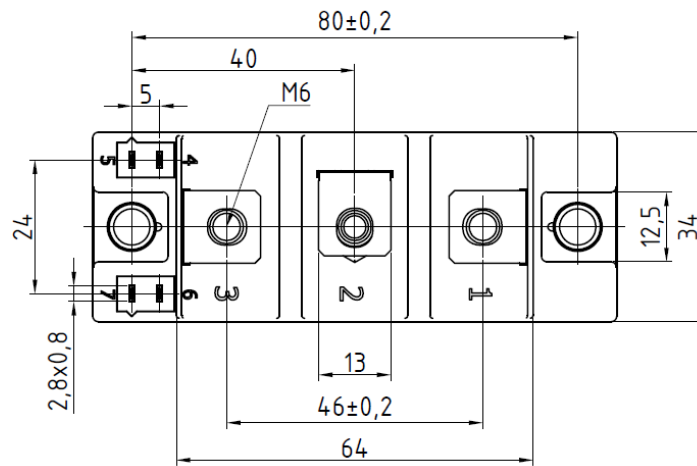
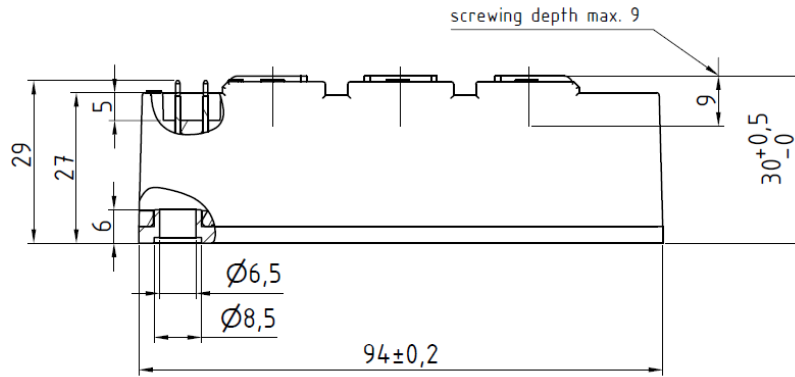

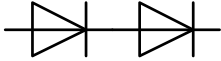

**Analytische Elemente des transienten Wärmewiderstandes  $Z_{thJC}$  für DC**  
**Analytical elements of transient thermal impedance  $Z_{thJC}$  for DC**

Pos. n	1	2	3	4	5	6	7
$R_{thn}$ [K/W]	0,0624	0,0024648	0,0674976	0,0076896			
$\tau_n$ [s]	0,035107	0,035092	0,034917	0,001473			

Analytische Funktion / Analytical function:

$$Z_{thJC} = \sum_{n=1}^{n_{max}} R_{thn} \left( 1 - e^{-\frac{t}{\tau_n}} \right)$$

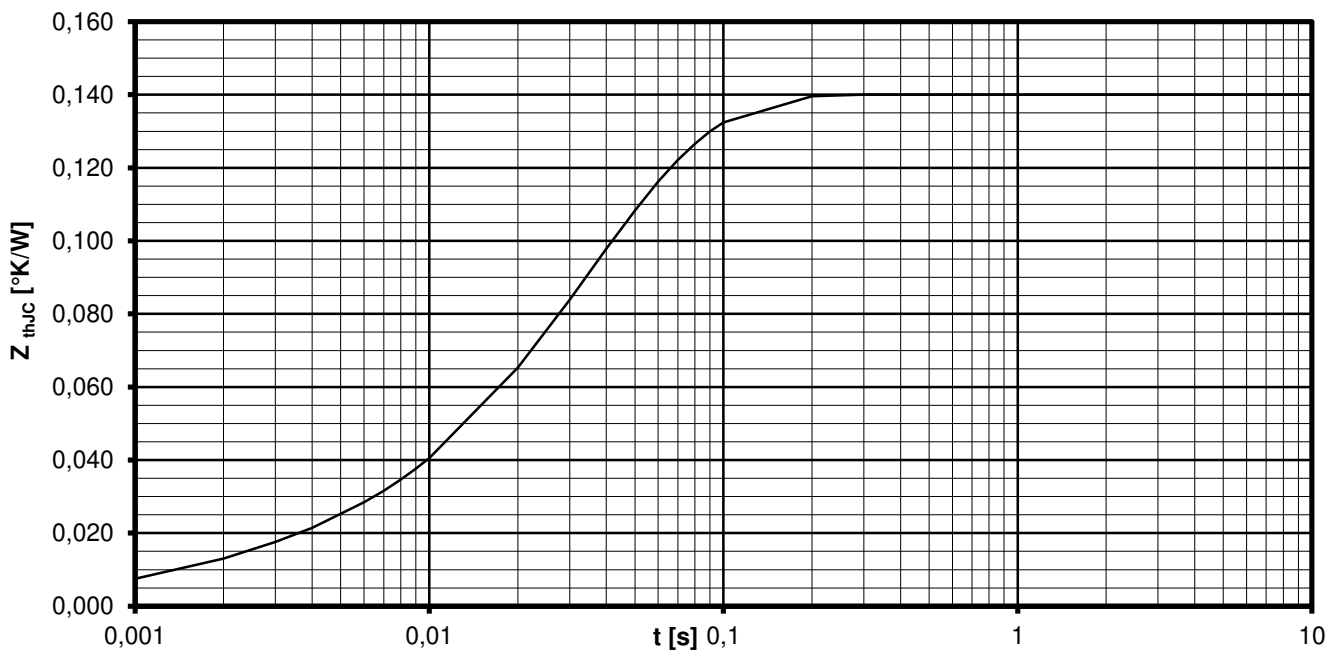

**Transienter innerer Wärmewiderstand je Zweig / Transient thermal impedance per arm  $Z_{thJC} = f(t)$**

Parameter: Stromflußwinkel  $\Theta$  / Current conduction angle  $\Theta$

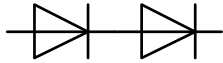

**Erhöhung des  $Z_{th DC}$  bei Sinus und Rechteckströmen mit unterschiedlichen Stromflusswinkeln  $\Theta$**   
**Rise of  $Z_{th DC}$  for sinewave and rectangular current with different current conduction angles  $\Theta$**

$\Delta Z_{th \Theta rec} / \Delta Z_{th \Theta sin}$

	$\Theta = 180^\circ$	$\Theta = 120^\circ$	$\Theta = 90^\circ$	$\Theta = 60^\circ$	$\Theta = 30^\circ$
$\Delta Z_{th \Theta rec}$ [K/W]	0,02645	0,04099	0,05159	0,06706	0,09217
$\Delta Z_{th \Theta sin}$ [K/W]	0,02007	0,0323	0,04668	0,06381	0,09023

$$Z_{th \Theta rec} = Z_{th DC} + \Delta Z_{th \Theta rec}$$

$$Z_{th \Theta sin} = Z_{th DC} + \Delta Z_{th \Theta sin}$$

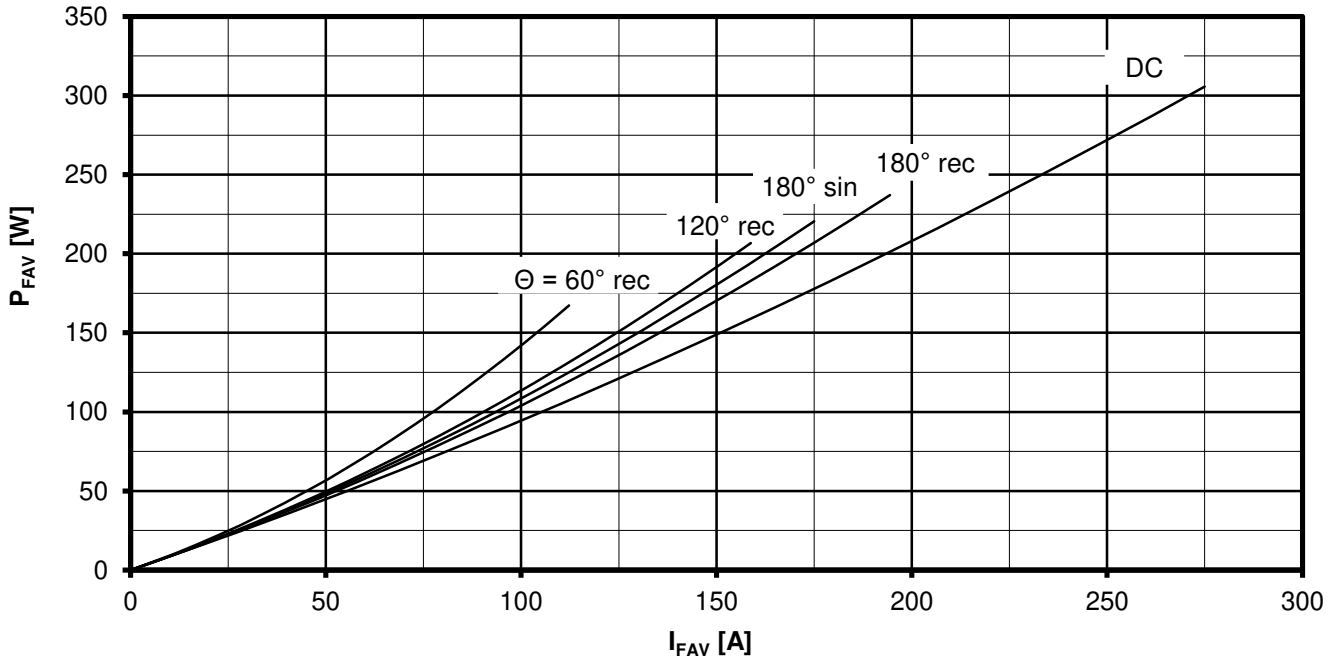
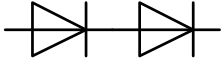

Durchlassverlustleistung je Zweig / On-state power loss per arm  $P_{FAV} = f(I_{FAV})$

Parameter: Stromflußwinkel / Current conduction angle  $\Theta$

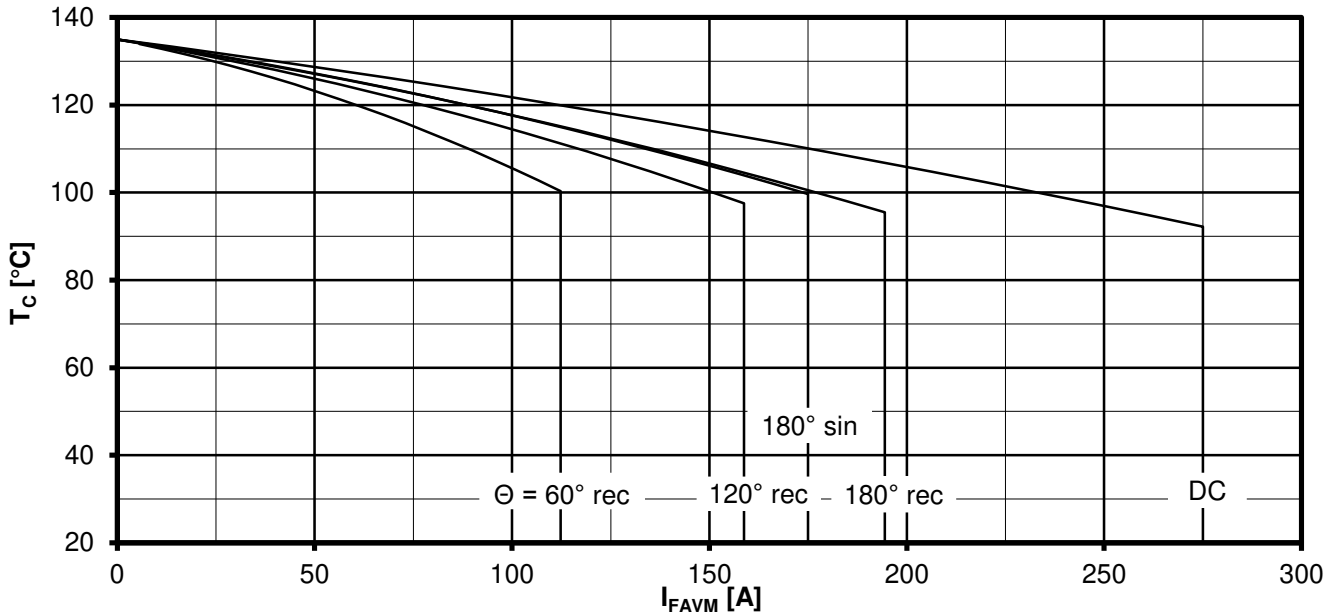

Höchstzulässige Gehäusetemperatur / Maximum allowable case temperature  $T_C = f(I_{FAVM})$

Strombelastung je Zweig / Current load per arm

Berechnungsgrundlage  $P_{TAV}$   
Calculation base  $P_{TAV}$

Parameter: Stromflußwinkel  $\Theta$  / Current conduction angle  $\Theta$



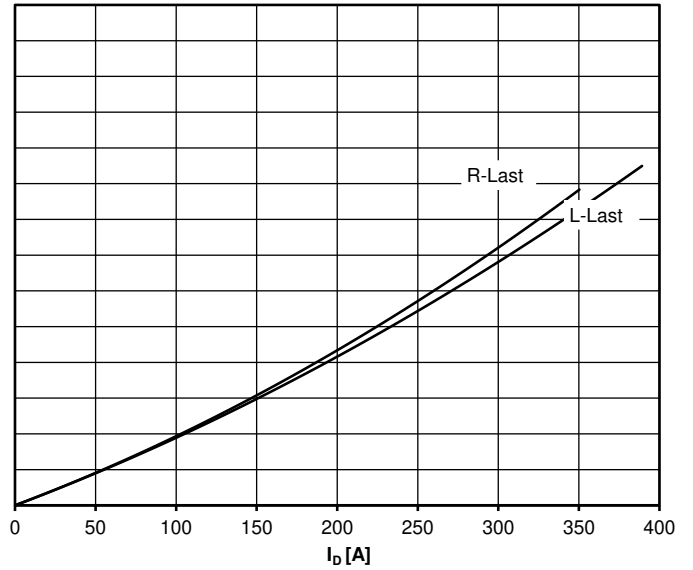
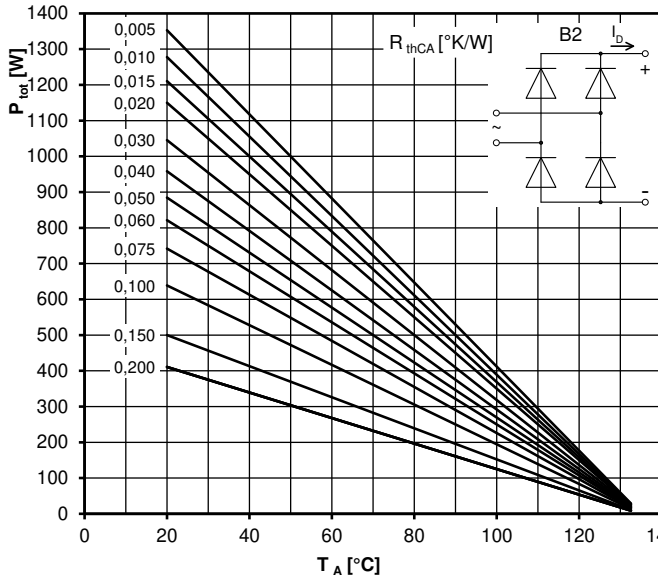
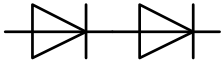

### Höchstzulässiger Ausgangsstrom / Maximum rated output current $I_b$

B2- Zweipuls-Brückenschaltung / Two-pulse bridge circuit

Gesamtverlustleistung der Schaltung / Total power dissipation at circuit  $P_{tot}$

Parameter:

Wärmewiderstand zwischen den Gehäusen und Umgebung / Thermal resistance cases to ambient  $R_{thCA}$

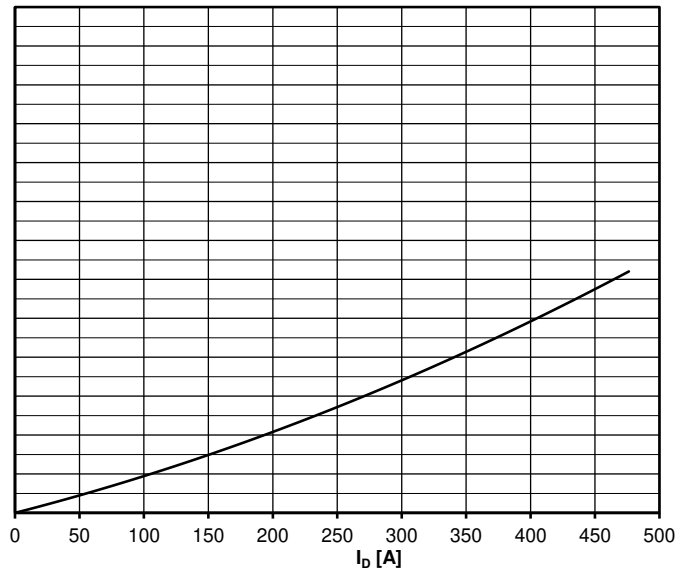
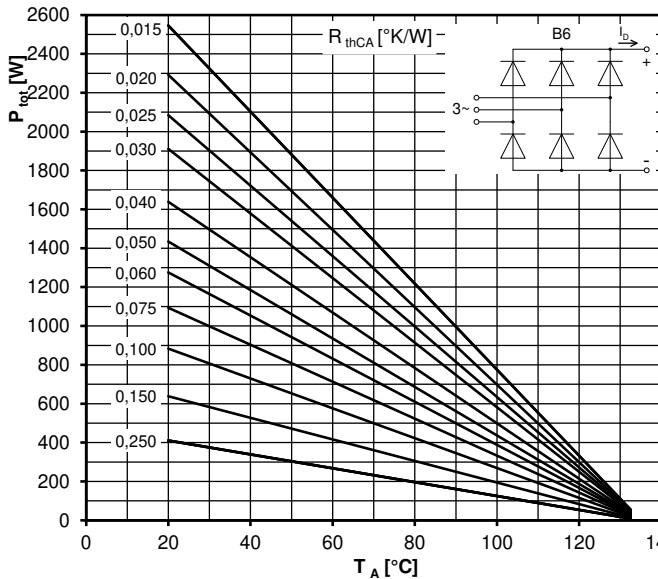

### Höchstzulässiger Ausgangsstrom / Maximum rated output current $I_b$

B6- Sechspuls-Brückenschaltung / Six-pulse bridge circuit

Gesamtverlustleistung der Schaltung / Total power dissipation at circuit  $P_{tot}$

Parameter:

Wärmewiderstand zwischen den Gehäusen und Umgebung / Thermal resistance cases to ambient  $R_{thCA}$

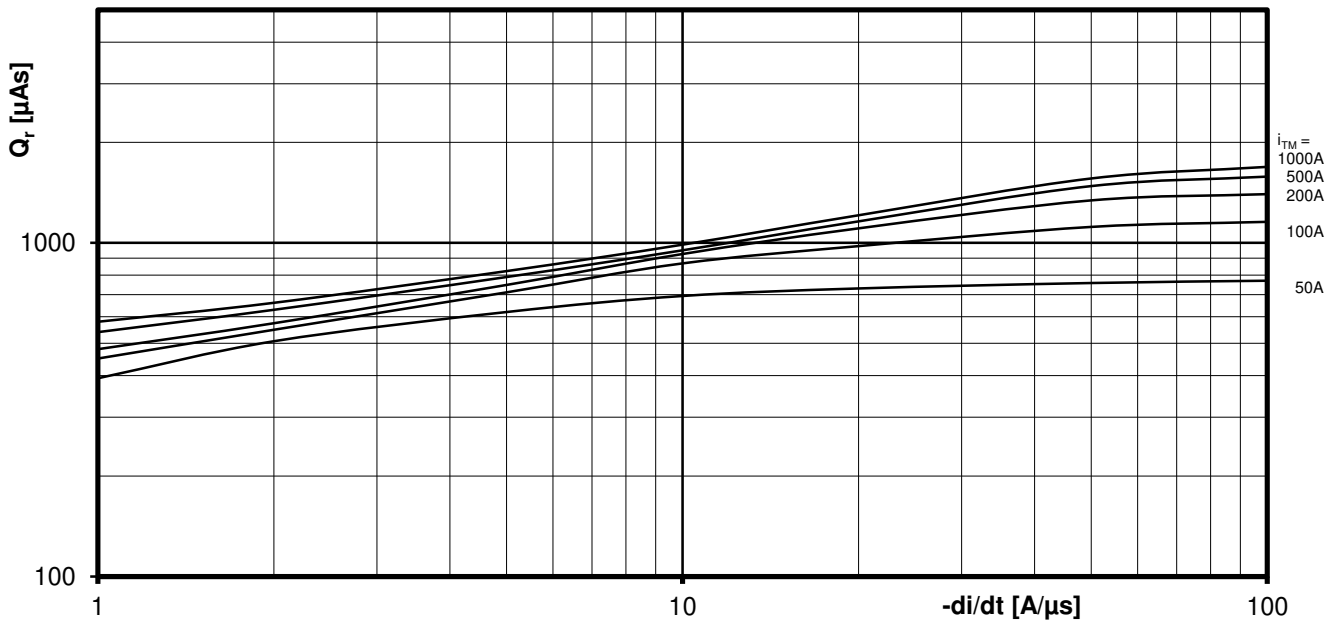
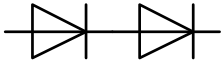

Sperrverzögerungsladung / Recovered charge  $Q_r = f(-di/dt)$

$$T_{vj} = T_{vjmax}, V_R \leq 0,5 V_{RRM}, V_{RM} = 0,8 V_{RRM}$$

Parameter: Durchlaßstrom / On-state current  $i_{FM}$

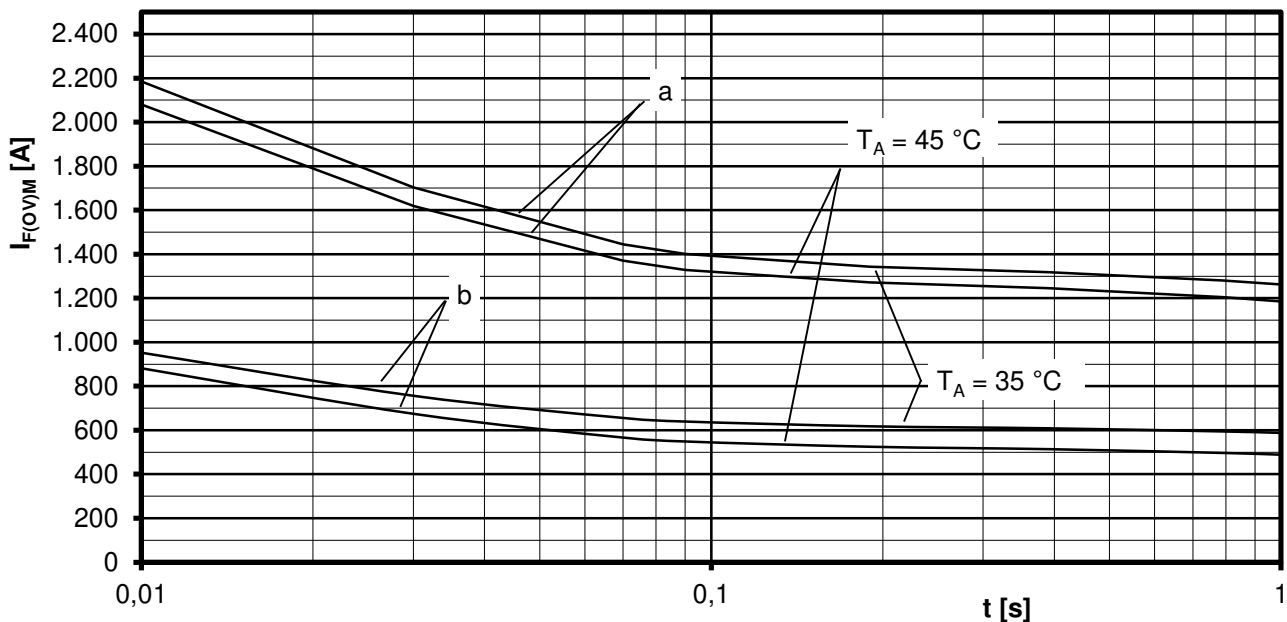

Grenzstrom je Zweig / Maximum overload on-state current per arm  $I_{F(OVM)} = f(t), V_{RM} = 0,8 V_{RRM}$

a: Leerlauf / No-load conditions

b: Vorlaststrom je Zweig / Pre-load current per arm  $I_{FAV(vor)} = I_{FAVM}$

$T_a = 35^\circ\text{C}$ , verstärkte Luftkühlung / Forced air cooling    Kühlkörper / Heatsink type: KM17 (Papst 4650)

$T_a = 45^\circ\text{C}$ , natürliche Luftkühlung / Natural air cooling    Kühlkörper / Heatsink type: KM17 (60W)

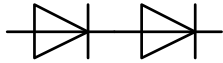

## Nutzungsbedingungen

Die in diesem Produktdatenblatt enthaltenen Daten sind ausschließlich für technisch geschultes Fachpersonal bestimmt. Die Beurteilung der Eignung dieses Produktes für Ihre Anwendung sowie die Beurteilung der Vollständigkeit der bereitgestellten Produktdaten für diese Anwendung obliegt Ihnen bzw. Ihren technischen Abteilungen.

In diesem Produktdatenblatt werden diejenigen Merkmale beschrieben, für die wir eine liefervertragliche Gewährleistung übernehmen. Eine solche Gewährleistung richtet sich ausschließlich nach Maßgabe der im jeweiligen Liefervertrag enthaltenen Bestimmungen. Garantien jeglicher Art werden für das Produkt und dessen Eigenschaften keinesfalls übernommen.

Sollten Sie von uns Produktinformationen benötigen, die über den Inhalt dieses Produktdatenblatts hinausgehen und insbesondere eine spezifische Verwendung und den Einsatz dieses Produktes betreffen, setzen Sie sich bitte mit dem für Sie zuständigen Vertriebsbüro in Verbindung (siehe [www.eupec.com](http://www.eupec.com), Vertrieb&Kontakt). Für Interessenten halten wir Application Notes bereit.

Aufgrund der technischen Anforderungen könnte unser Produkt gesundheitsgefährdende Substanzen enthalten. Bei Rückfragen zu den in diesem Produkt jeweils enthaltenen Substanzen setzen Sie sich bitte ebenfalls mit dem für Sie zuständigen Vertriebsbüro in Verbindung.

Sollten Sie beabsichtigen, das Produkt in gesundheits- oder lebensgefährdenden oder lebenserhaltenden Anwendungsbereichen einzusetzen, bitten wir um Mitteilung. Wir weisen darauf hin, dass wir für diese Fälle

- die gemeinsame Durchführung eines Risiko- und Qualitätsassessments;
- den Abschluss von speziellen Qualitätssicherungsvereinbarungen;
- die gemeinsame Einführung von Maßnahmen zu einer laufenden Produktbeobachtung dringend empfehlen und gegebenenfalls die Belieferung von der Umsetzung solcher Maßnahmen abhängig machen.

Soweit erforderlich, bitten wir Sie, entsprechende Hinweise an Ihre Kunden zu geben.

Inhaltliche Änderungen dieses Produktdatenblatts bleiben vorbehalten.

## Terms & Conditions of usage

The data contained in this product data sheet is exclusively intended for technically trained staff. You and your technical departments will have to evaluate the suitability of the product for the intended application and the completeness of the product data with respect to such application.

This product data sheet is describing the characteristics of this product for which a warranty is granted. Any such warranty is granted exclusively pursuant the terms and conditions of the supply agreement. There will be no guarantee of any kind for the product and its characteristics.

Should you require product information in excess of the data given in this product data sheet or which concerns the specific application of our product, please contact the sales office, which is responsible for you (see [www.eupec.com](http://www.eupec.com), sales&contact). For those that are specifically interested we may provide application notes. Due to technical requirements our product may contain dangerous substances. For information on the types in question please contact the sales office, which is responsible for you.

Should you intend to use the Product in health or live endangering or life support applications, please notify. Please note, that for any such applications we urgently recommend

- to perform joint Risk and Quality Assessments;
- the conclusion of Quality Agreements;
- to establish joint measures of an ongoing product survey, and that we may make delivery depended on the realization of any such measures.

If and to the extent necessary, please forward equivalent notices to your customers.

Changes of this product data sheet are reserved.